

Firestone

World's Number 1
Air Spring.



FIRESTONE INDUSTRIAL PRODUCTS COMPANY

Air Spring Replacement Guide



www.firestoneip.com

aftcat1109

Firestone

**World's Number 1
Air Spring.**



FIRESTONE INDUSTRIAL PRODUCTS COMPANY

**NORTH AMERICAN
2010
EDITION**

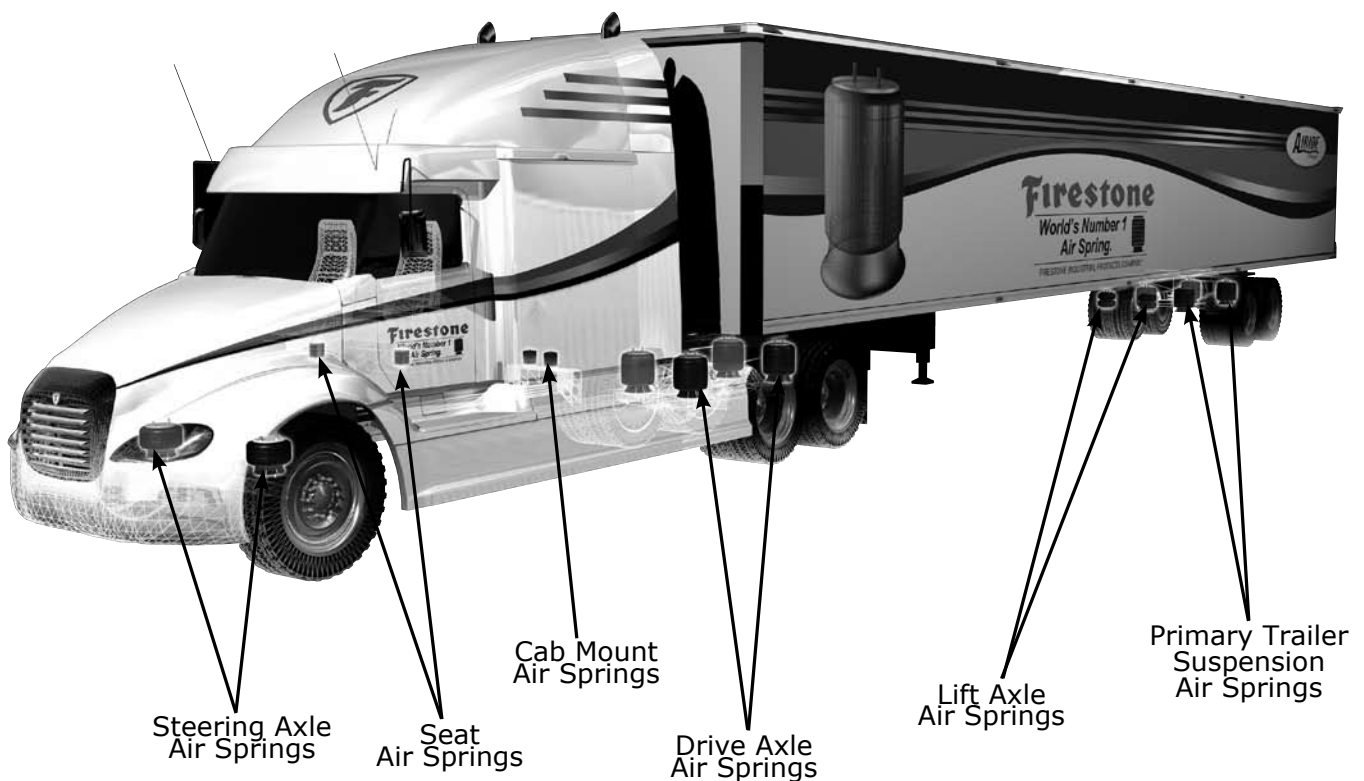

The information contained in this publication is intended to provide a general guide for the identification and application of these products. The material, herein, was compiled from our close working relationship with the OEM suspension manufacturers and is believed to be reliable and accurate. Firestone, however, makes no warranty, expressed or implied, of this information. Anyone making use of this information does so at his own risk and assumes all liability resulting from such use. It is suggested that competent professional assistance be employed for specific applications.

Table of Contents

Although air springs are produced in single, double and triple convoluted and reversible sleeve styles, only those manufactured by Firestone Industrial Products Company bear the trademark "Airide™."

Airide springs were pioneered and perfected by Firestone, and only Firestone offers a complete line of Airide springs, with replacement springs available for virtually every vehicular air suspension system. Today, Airide springs are used by practically all manufacturers who offer air suspension on their vehicles.

While it may appear simple, an air spring is actually a highly sophisticated and complex product. Even slight changes in design, methods of construction, or materials used can make vast and significant differences in performance.

It makes good sense to specify Airide springs by Firestone. That trade name on an air spring guarantees you the benefit of the very latest technical developments and improvements. It is your assurance of a product not only engineered and perfected to perform, but which also has a long history of superior performance in actual use.



Firestone Airide™ springs.....	1
Components of Airide springs	2
Identifying Airide springs.....	3
General Specifications.....	4

I. 1T Reversible Sleeve Style Springs	
Reading the Parts Table	5-6
Parts Tables.....	7-95

II. Convoluted Style Springs	
Reading the Parts Table	96-97
Single Convoluted	98-101
Double Convoluted.....	101-122
Triple Convoluted	122-133

III. Sleeve Style Springs	
(Cab, Seat & Miscellaneous Applications)	
Reading the Parts Table	134
Components of Sleeve style springs	135
Parts Tables by Logo Color.....	136-155

IV. Cross Reference Information	
Sleeve Cross Reference by Manufacturer	156-158
Sleeve by Cap and Piston Drawing No.	159-160
Sleeve by Cap and Piston Component No.....	161-162
1T & Convoluted Manufacturer to Firestone No.....	163-182
OE Suspension Index.....	183-188
1T & Convoluted Goodyear to Firestone Number	189-198
1T & Convoluted Triangle to Firestone Number	199-208
1T & Convoluted Contitech Assembly to Firestone	209-213
1T & Convoluted Bellows Indexes	214-218
1T Piston Indexes.....	219-234
All Parts Assembly Order Number Index.....	235-240

V. Miscellaneous	
Added and Removed Items	241
Warranty.....	243-246
Alignment Definitions.....	247

1T Style Springs

Convoluted Style Springs

Sleeve Style Springs

Cross Reference

The Components of Airide™ springs

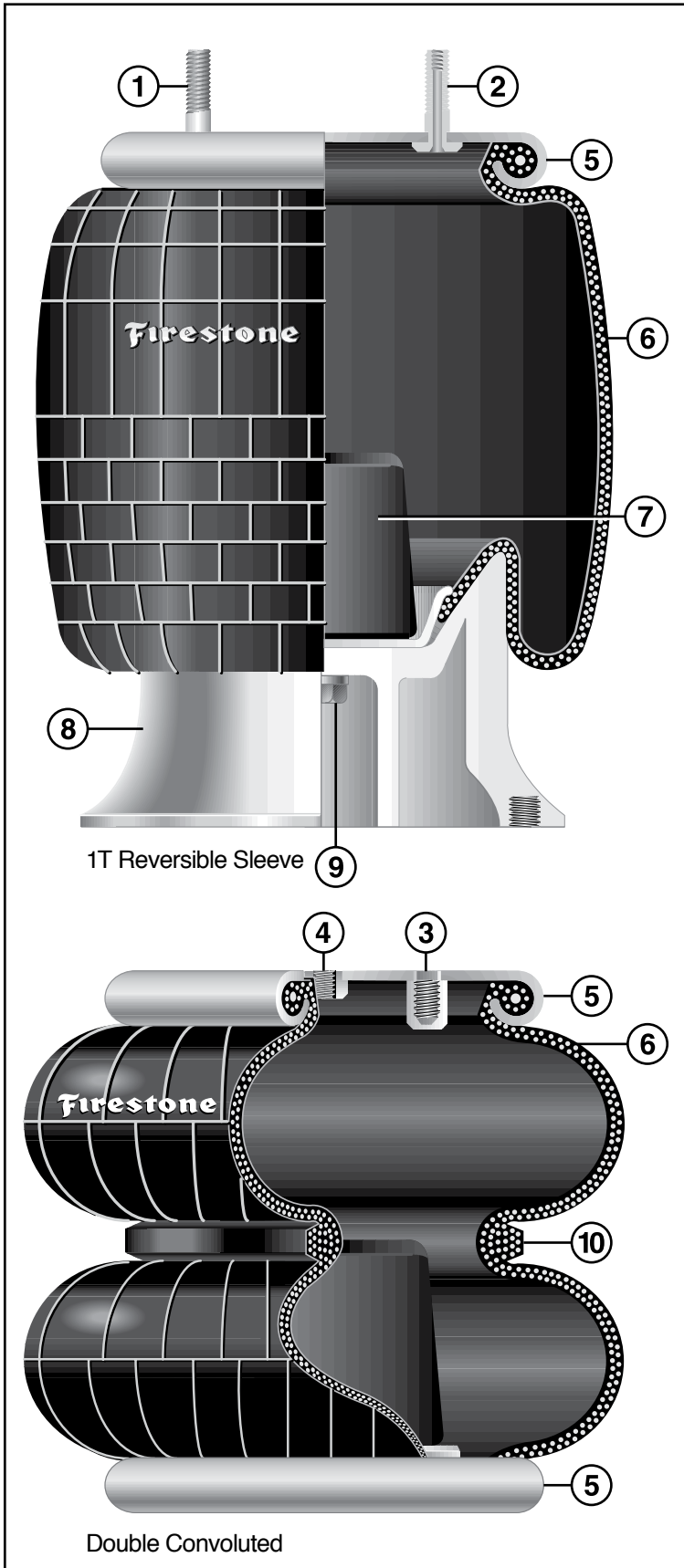

1. Stud

A permanent part of the bead plate assembly used to attach the airspring to the suspension.

2. Combo Stud

Combination mounting stud and air fitting.

3. Blind Nut

A permanent part of the bead plate assembly providing an alternate mounting system to the stud.

4. Air Fitting Hole

A tapped hole usually 1/4" N.P.T. providing air entrance for the part.

5. Bead Plate

Permanently crimped onto the bellows at the factory allowing complete part leak testing prior to shipment.

6. Bellows

The heart of an Airide spring. Includes at least four plies, or layers, of material—an inner layer, two plies of cord-reinforced fabric, and an outer layer.

7. Bumper (Optional)

A solid molded rubber fail-safe device used on many suspension applications. Prevents excessive damage to vehicle and suspension in the case of sudden air pressure loss.

8. Piston

The lower section of the 1T and 1X style of airspring made from aluminum, steel or fiber reinforced plastic. Provides lower mounting arrangement for the airspring in the form of tapped holes or studs.

9. Piston Bolt

Attaches the piston to the bellows assembly. Extended, in some cases, to serve as a means of attaching the spring to the suspension.

10. Girdle Hoop

A ring between the convolutions of the convoluted-type air spring.

Service Assembly

On Firestone Airide springs of the 1T style, the rubber bellows bead plate portion of the spring is a separate hermetically sealed unit, available for replacement use without the piston. Called a "service assembly," it includes a bead plate, bellows, internal bumper (if any), and all attaching hardware.

Identifying Airide™ springs

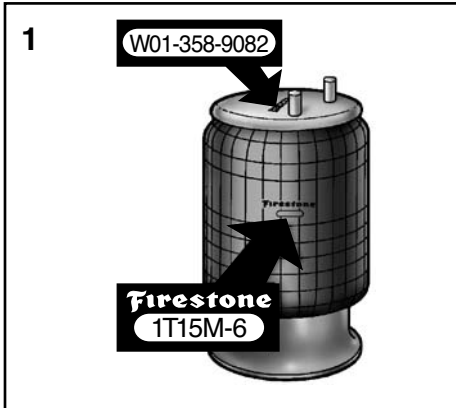

1. Read AON and bellows number.

The first step to identifying an Airide™ spring for replacement is to read the assembly order number on the label adhered to the bead plate (i.e., W01-358-9082). If the number is illegible, read the bellows number which is normally molded directly underneath the Firestone logo. A style number such as 1T15M-6 or 22 would tell exactly which bellows is needed and one could skip steps 2 and 3.

If the bellows number is illegible, then determine whether it is a convoluted style or a 1T style by comparing it to the pictures in this guide. Proceed to step 2 if 1T style or step 3 if convoluted.

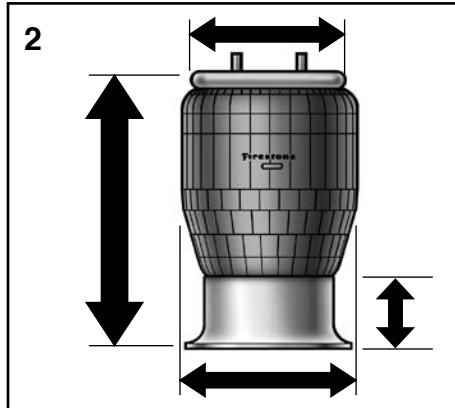

2. 1T Style

Measure the bead plate diameter and molded (**uninflated**) diameter of the rubber bellows and compare this with the 1T styles in the bellows index until a match is found (please note that the molded diameter can grow slightly with years of service). Then measure from the bottom of the piston to the top of the bead plate while the part is **uninflated** and **extended**. Next, find this same or similar measurement in the specific bellows section that was previously determined. When this has been done, skip to step 4. If the piston number is illegible in step 5, measure the piston height and compare it to pictures with the same dimensions.

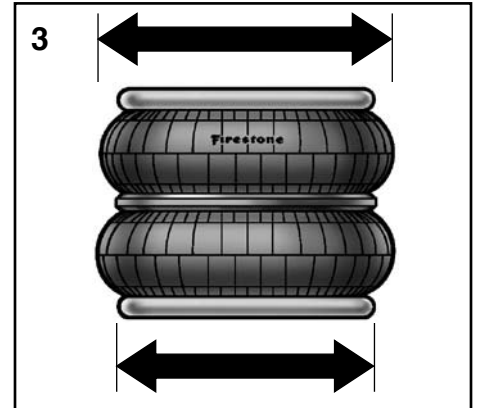

3. Convoluted style

First determine whether it is a single, double, or triple convoluted style by comparing it to the pictures in this guide. Then measure the bead plate diameter and the diameter of the bellows (**uninflated**) across its widest area and compare these dimensions with those given in the bellows index. Once a match has been made, proceed to step 4.

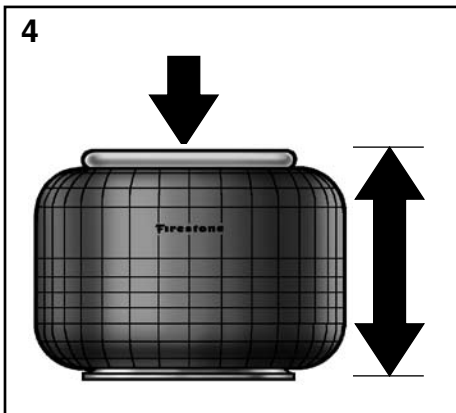

4. Rubber Bumper

Many Airide™ springs include a rubber bumper inside the spring. To determine if one is present, compress the spring to its minimum height and measure from the bottom plate or piston to the top of the bead plate.

Compare this compressed height with the pictures in the appropriate bellows section that was determined in step 2 (1T style) or step 3 (convoluted style). Proceed to step 5 if you have a 1T style spring or step 6 if you have a convoluted spring.

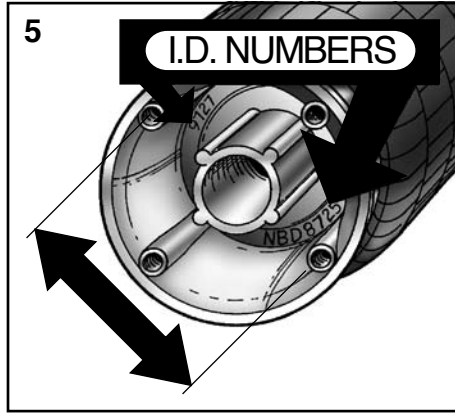

5. 1T style (bead plate and piston)

The same bellows is used with many different combinations of bead plates and pistons, so be sure to check closely. Compare the bead plate and piston with the pictures from the "Cross Section View", "Bead Plate Top View" and "Piston Bottom View" columns from the appropriate bellows section that was previously determined. Also, verify that the alignment (bead plate mounting in reference to piston mounting holes) is correct.

In addition, the piston can be further verified by reading the identification numbers inside the piston and comparing these with those shown in the "Piston Bottom View" or piston index. Once a match has been determined, the corresponding assembly order number (i.e. W01-358-9082) can be used to order the part.

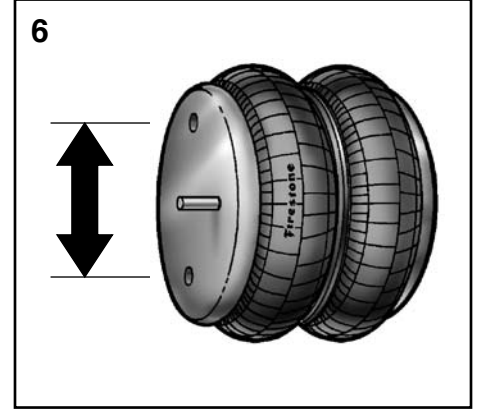

6. Convoluted style (bead plates)

The same bellows is used with many different combinations of bead plates. Compare these bead plates with those diagrammed in this guide under the "Bead Plate Top View" and "Bead Plate Bottom View" columns for the specific style convoluted part that was previously determined and find the unit with the identical hardware, measurements and alignment (top bead plate mounting in reference to lower bead plate mounting). Once a match has been determined, the corresponding assembly order number (e.g., W01-358-7135) can be used to order the part.

General Specifications

Fastener Tightening Specifications		
Description	Size	Torque (lb-ft)
· Bead ring nuts on bolts	5/16-24	17-22
· Bead ring bolts and nuts	3/8-24	28-32
· Bolts in blind nuts in bead plates	3/8-16	15-20
· End of adapter studs in blind nut	3/8-16	15-20
· Nut on end of adapter stud	1/2-13	25-30
· Studs on bead plates or blind nuts	1/2-13 or 1/2-20 M12 x 1.75	25-30
· Bolt to attach piston base to lower mounting surface	1/2-13	25-30
· Nut on air entrance stud	3/4-16 M16 x 1.5 M20 x 1.5	40-45
· Nut to an entrance stud	1 5/16-12UNF 1 1/4-12UNF	45-50
· NPT air supply fitting	1/4 & up	17-22
· Nut on end closure lower mounting	3/4-10	45-50

Operational Cautions

Air spring failure can be caused by a variety of situations, including internal or external rubbing, excessive heat and overextension. For further details, refer to Warranty Considerations.

Temperature/Pressure Range

The ambient operating temperature range for standard vehicular air springs may vary. See the website for temperature ranges for individual parts by part number. The maximum pressure is 100 psi.

Bumpers

In general, bumpers are used to support the vehicle weight to prevent damage to the flexible member during times when no air is in the system. They are also used as stops when the axle is raised by a lift unit. In applications that require frequent bumper contact, consult Firestone.

Down and Up Stops

Positive stops in both directions (compression and extension) should always be used with Airide™ springs.

1. In COMPRESSION, the minimum height shown for each air spring is at, or slightly above the PINCH POINT of the bellows. Here is a #22 shown in the collapsed or "pinch point" condition:

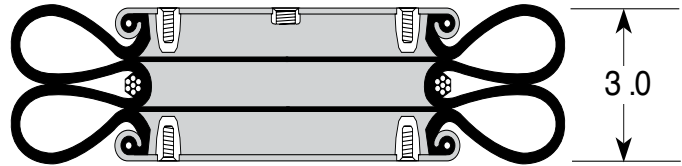

The bellows can be damaged if allowed to constantly bottom out as shown above; therefore, a downstop is required to prevent this. An external downstop can be something as simple as a steel block and should be sized at or slightly greater than the minimum height of the Airide™ spring. In our #22 example, the block would need to be at least 3.0 inches high. If an external downstop cannot be used, many parts are available with internal rubber bumpers.

2. In EXTENSION, an upstop is necessary to prevent the air spring from overextending. The reasons for this are twofold: a) the life of the bellows may be reduced, and b) the crimp may open up, allowing the bellows bead to blow out of the metal end closure. There are many ways to design-in an upstop, including:

- a. shocks,
- b. a chain,
- c. a cable or strap,
- d. contacting a metal stop, etc.

Contaminates

Shielding should be used to protect the bellows from exposure to hot metal, sand, petroleum base fluids, acids, etc. Please consult Firestone if you wish to know how the bellows will withstand a specific contaminant (For liquids such as acids, it is important to know both concentration and temperature.)

Storage

The best storage environment is a dark, dry area at normal room temperature.

WARNING

DO NOT INFLATE ASSEMBLY WHEN IT IS UNRESTRICTED. ASSEMBLY MUST BE RESTRICTED BY SUSPENSION OR OTHER ADEQUATE STRUCTURE. DO NOT INFLATE BEYOND PRESSURES RECOMMENDED IN DESIGN LITERATURE (CONTACT FIRESTONE FOR INFORMATION). IMPROPER USE OR OVERINFLATION MAY CAUSE ASSEMBLY TO BURST CAUSING PROPERTY DAMAGE OR SEVERE PERSONAL INJURY.

Reading the parts table for 1T-reversible sleeve style springs

1	2	3	4	5	6
BELLOW # ASSEMBLY ORDER NO.	CROSS SECTION VIEW	BEAD PLATE TOP VIEW	PISTON BOTTOM VIEW	ASSEMBLY WEIGHT	REPLACES
1T15L-4 W01-358- 9415 Service Assembly #0701				17.47	Kenworth K-303-5

Hardware Key

- Bolt or Stud 1/2-13 ● Threaded Hole 3/8-16 Blind Nut on Bead Plates 1/2-13 Pistons ⊗ Air Inlet 1/4 N.P.T. No Alignment Specified-Center Stud Mounting is Standard
- ⊗ Combination Stud/Air Inlet Stud Outside Thread is 3/4-16 Studs Inside Thread (Air Inlet) is 1/4 N.P.T. Exceptions Will Be Noted on Part View as ⊗

1. Bellows # and Assembly Order Number (AON)

This number identifies the specific bellows number and the assembly order number for ordering purposes. Complete Order No. for any type of electronic ordering (EDI) is W01-358-9415.

2. Airide Cross Section View

A cross sectional view of the Airide spring showing dimensional information in inches on **uninflated** diameter, maximum height, and collapsed height. A bumper drawing number is also referenced, if applicable (e.g.-3159).

3. Bead Plate–Top View

A top view of the upper bead plate with dimensional information and detail on mounting attachments (see hardware key). An Internal Firestone Reference Number is also shown.

4. Piston–Bottom View

A bottom view of the piston with dimensional information and detail on mounting attachments (see hardware key). The Internal Firestone Reference Number (4 digit) and the piston drawing number are also shown. Both of these numbers are molded in the underside of the piston for identification purposes. If available, a 4 digit order number is shown to order the piston separately (complete number for EDI purposes, WC1-358-0606).

5. Assembly Weight

Gives total weight of the assembly in pounds.

6. Replaces

Vehicle and suspension manufacturers' part numbers for the particular Airide springs.

7. Service Assembly

On Firestone Airide springs of the 1T style, the rubber bellows bead plate portion of the spring is a separate hermetically sealed unit, available for replacement use without the piston. Called a "service assembly," it includes a bead plate, bellows, internal bumper (if any), and all attaching hardware. Please note the service assembly has its own separate ordering number. For example, a W01-358-9082 uses Service Assembly Order Number W01-358-0712.

1T Reversible Sleeve Style



The Firestone 1T or Reversible Sleeve type spring is the most popular style used on suspensions. Most replacement work will probably be with this style.

Identification of the proper replacement assembly requires identifying the bellows type and the bead plate and piston type used, as well as whether the spring includes an internal rubber bumper.

As with other styles, the quickest way to identify the airspring is to read the manufacturer or Firestone order number on the bead plate. If the number is illegible, read the part number molded on the bellows, normally directly under the Firestone name. This will lead you directly to the proper section of the guide, narrowing your choice of assemblies to just a few.

Should the bellows number be unreadable, the type can still be determined by measuring the bead plate diameter and the bellows diameter (**uninflated**) and comparing this with the 1T styles in the bellows index until you find a match. Then measure the extended height as shown and compare this measurement with the maximum height shown in the "Cross Section View" of the parts tables for the general style of bellows (1T14, 1T15, 1T17 etc.) that was previously determined.

To determine whether the spring has an internal bumper, remove the air and compress the spring to its minimum collapsed height. Measure this, as shown, and compare it to the minimum height shown in the parts tables.

Finally, to complete identification of the assembly, carefully compare the bead plate and piston with those listed in the tables until you find a match.

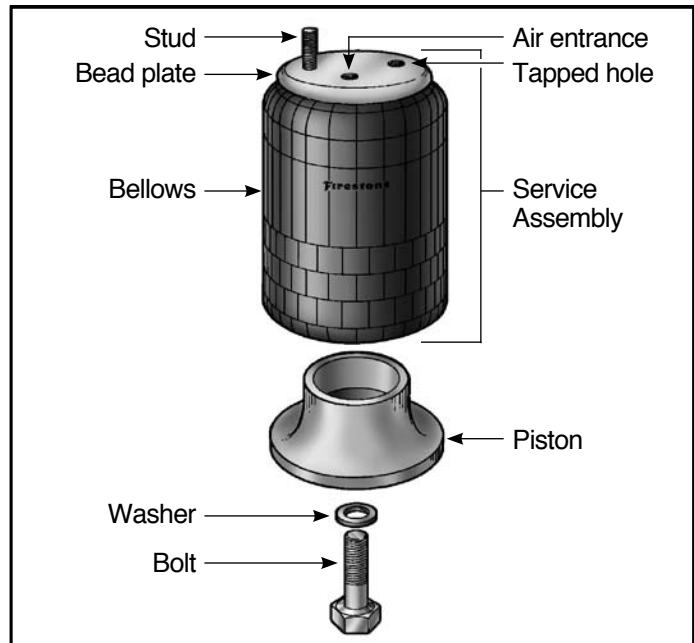

Service Assembly Most 1T style springs are available as either a complete assembly, including the piston, or as a service assembly, which includes the bellows and bead plate only. Before you order a service assembly only, we advise close inspection of the piston to be reused. A slight imperfection or build-up of corrosion or dirt on the piston may cause a new bellows to wear out prematurely.

Special Note Further information on pistons used with 1T style springs can be found in the Piston Index section of this catalog.

In addition to the center attaching hole, most newer pistons have four threaded holes in the outer diameter to make the piston more universal. All of the outer holes may not be used in some cases. Check the drawing for the assembly you are replacing to be sure.

Some pistons are also supplied with threaded studs inserted in the proper mounting holes on the piston. Be certain to check the listings for this feature as well.

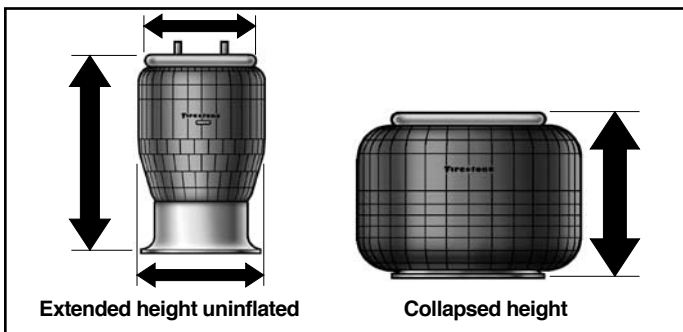

1T - Reversible Sleeve

BELLOW NO. ASSEMBLY ORDER NO.	CROSS SECTION VIEW	BEAD PLATE TOP VIEW	PISTON BOTTOM VIEW	ASSEMBLY WEIGHT (lbs.)	REPLACES
1T14C-1			<p>Order No. WC1-358-0609</p>	5.9	Granning 5122 Hendrickson Trailer S2394 Rowe Truck AS- C1400HL Lift
W01-358-2119					
1T14C-1			<p>Order No. WC1-358-9095</p>	7.0	Granning 5691 Granning 6104 (no stud) Rowe Truck ASCS2000 Lift Rowe Trailer ASCST2000
W01-358-2120					
1T14C-1			<p>Order No. WC1-358-0609</p>	5.9	Kelderman
W01-358-2131					
1T14C-1			<p>Order No. WC1-358-0600</p>	6.4	American Carrier 9003-001 Hendrickson Trailer S8832 Ridewell 1003585310C Circle R
W01-358-5310					
1T14C-1			<p>Order No. WC1-358-0600</p>	6.7	Ridewell 1003585311C
W01-358-5311					

1T Style Springs

Hardware Key

- Bolt or Stud 1/2-13 ⊗ Threaded Hole 3/8-16 Blind Nut on Bead Plates 1/2-13 Pistons ⊗ Air Inlet 1/4 N.P.T. No Alignment Specified-Center Stud Mounting is Standard
- ⊗ Combination Stud/Air Inlet Stud Outside Thread is 3/4-16 Studs Inside Thread (Air Inlet) is 1/4 N.P.T. Exceptions Will Be Noted on Part View as ⊗

Firestone

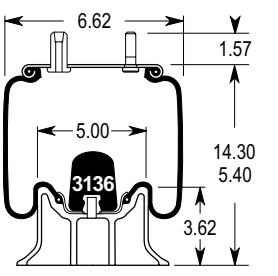
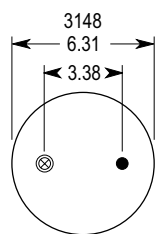
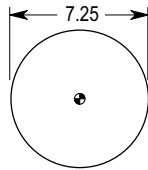
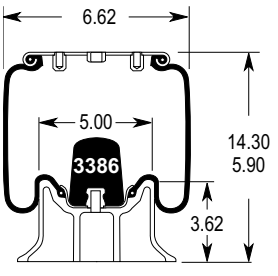
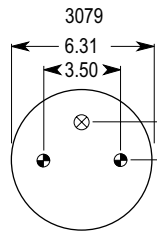
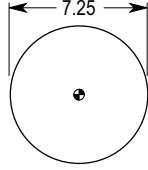
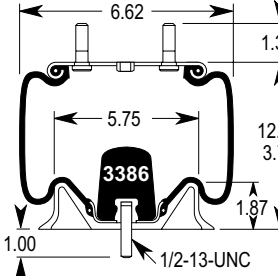
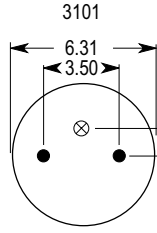
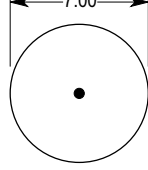
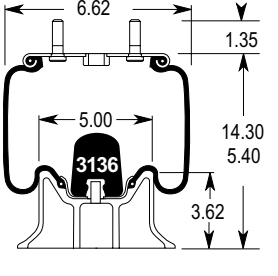
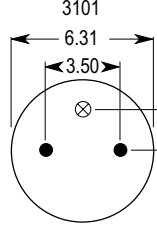
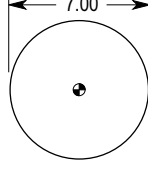
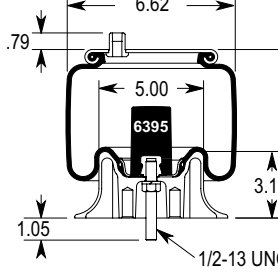
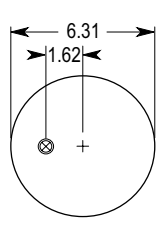
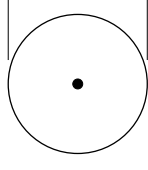
BELLOW NO. ASSEMBLY ORDER NO.	CROSS SECTION VIEW	BEAD PLATE TOP VIEW	PISTON BOTTOM VIEW	ASSEMBLY WEIGHT (lbs.)	REPLACES
1T14C-1 W01-358-5323			9708/NBD-8626  Order No. WC1-358-0600	6.8	Air Ax (Roelofs) Granning 7504 Ridewell 1003585323C
1T14C-1 W01-358-5328			9708/NBD-8626  Order No. WC1-358-0600	6.9	American Carrier 8003-017
1T14CB-1 W01-358-5297			9555/NBD-10500  Order No. WC1-358-0609	6.0	Watson & Chalin AS-0106
1T14CB-1 W01-358-5319			9508/NBD-10441  Order No. WC1-358-0754	6.3	Monaco Coach 8618
1T14CB-1 W01-358-8872			9651/NBD-11498  Order No. WC1-358-9095	6.6	Hendrickson 64827-2

Hardware Key

- Bolt or Stud 1/2-13 ⊕ Threaded Hole 3/8-16 Blind Nut on Bead Plates 1/2-13 Pistons ⊗ Air Inlet 1/4 N.P.T. No Alignment Specified-Center Stud Mounting is Standard
- ⊗ Combination Stud/Air Inlet Stud Outside Thread is 3/4-16 Studs Inside Thread (Air Inlet) is 1/4 N.P.T. Exceptions Will Be Noted on Part View as ⊗

1T - Reversible Sleeve

BELLOW NO. ASSEMBLY ORDER NO.	CROSS SECTION VIEW	BEAD PLATE TOP VIEW	PISTON BOTTOM VIEW	ASSEMBLY WEIGHT (lbs.)	REPLACES
1T14CB-1 W01-358-8992			9555/NBD-10500 Order No. WC1-358-0609	5.9	Ridewell 1003588992C
1T14CB-1 W01-358-8997			9555/NBD-10500 Order No. WC1-358-0609	6.0	Holland (Neway) 90557034 90557029 Watson & Chalin (AS-0026) Ridewell 1003588997C Silent Drive
1T14C-3 W01-358-5405			9708/NBD-8626 Order No. WC1-358-0600	6.6	Circle R Hendrickson Trailer S9346
1T14C-3 W01-358-5406			9708/NBD-8626 Order No. WC1-358-0600	6.7	Granning 1971
1T14C-3 W01-358-5408			9708/NBD-8626 Order No. WC1-358-0600	6.3	Jet Company

1T Style Springs

Hardware Key

- Bolt or Stud 1/2-13 ⊗ Threaded Hole 3/8-16 Blind Nut on Bead Plates 1/2-13 Pistons ⊗ Air Inlet 1/4 N.P.T. No Alignment Specified-Center Stud Mounting is Standard
- ⊗ Combination Stud/Air Inlet Stud Outside Thread is 3/4-16 Studs Inside Thread (Air Inlet) is 1/4 N.P.T. Exceptions Will Be Noted on Part View as ⊗

Firestone

BELLOW NO. ASSEMBLY ORDER NO.	CROSS SECTION VIEW	BEAD PLATE TOP VIEW	PISTON BOTTOM VIEW	ASSEMBLY WEIGHT (lbs.)	REPLACES
1T14C-3 W01-358-5410				8.0	Granning 2112 Watson & Chalin AS-0029 Ridewell 1003585410C
1T14C-3 W01-358-5412				8.2	American Carrier 8003-011 Oshkosh Neway 90057057
1T14C-3 W01-358-5414				8.6	Air AX (Roelofs) Ridewell 1003585414C
1T14C-3 W01-358-5422				6.9	Circle R
1T14C-3 W01-358-5423				7.2	Granning 5235 Granning 5307 (no stud) Rowe Truck AS-C1500/ASCS1500/ ASCS2000 Lift Rowe Trailer ASCT1500/ ASCST1500/ ASCST2000

Hardware Key

- Bolt or Stud 1/2-13
- ⊗ Threaded Hole 3/8-16 Blind Nut on Bead Plates 1/2-13 Pistons
- ⊗ Air Inlet 1/4 N.P.T.
- ⊗ No Alignment Specified-Center Stud Mounting is Standard
- ⊗ Combination Stud/Air Inlet Stud Outside Thread is 3/4-16
- ⊗ Studs Inside Thread (Air Inlet) is 1/4 N.P.T. Exceptions Will Be Noted on Part View as ⊗

1T - Reversible Sleeve

BELLOW NO. ASSEMBLY ORDER NO.	CROSS SECTION VIEW	BEAD PLATE TOP VIEW	PISTON BOTTOM VIEW	ASSEMBLY WEIGHT (lbs.)	REPLACES
1T14C-3 W01-358-5433			 Order No. WC1-358-0686	8.2	Watson & Chalin AS-0069
1T14C-3 W01-358-5434			 Order No. WC1-358-0600	7.3	Granning 7765
1T14C-3 W01-358-5436			 Order No. WC1-358-0600	7.4	Granning 7831
1T14C-3 W01-358-9478			 Order No. WC1-358-0754	6.8	Granning 6250
1T14C-5 W01-358-5335			 Order No. WC1-358-0686	8.8	General Coach

1T Style Springs

Hardware Key

- Bolt or Stud 1/2-13 ⊗ Threaded Hole 3/8-16 Blind Nut on Bead Plates 1/2-13 Pistons ⊗ Air Inlet 1/4 N.P.T. No Alignment Specified-Center Stud Mounting is Standard
- ⊗ Combination Stud/Air Inlet Stud Outside Thread is 3/4-16 Studs Inside Thread (Air Inlet) is 1/4 N.P.T. Exceptions Will Be Noted on Part View as ⊗

Firestone

BELLOW NO. ASSEMBLY ORDER NO.	CROSS SECTION VIEW	BEAD PLATE TOP VIEW	PISTON BOTTOM VIEW	ASSEMBLY WEIGHT (lbs.)	REPLACES
1T14C-5 W01-358-5336 TANK VALVE WC1-358-0009			9778/NAD-18053 Order No. WC1-358-0686	8.0	John Deere AH160823
1T14C-5 W01-358-8868			9651/NBD-11498 Order No. WC1-358-9095	7.1	Hendrickson 57965-2 (reuse old bracket) Supersedes Hendrickson 57839 Hendrickson 57920-2 w/bracket Includes Bracket 57966-2 (left) 57967-2 (right)
1T14C-6 W01-358-5439			9754/NBD-11689 Order No. WC1-358-1603	10.3	Link 1103-0500 Ultradire
1T14C-6 W01-358-8977			9754/NBD-11689 Order No. WC1-358-1603	10.4	Granning 5301 General Coach Air Ax (Roelofs)
1T14C-6 W01-358-8979			9754/NBD-11689 Order No. WC1-358-1603	10.0	Granning 5553

Hardware Key

- Bolt or Stud 1/2-13
- ⊕ Threaded Hole 3/8-16 Blind Nut on Bead Plates 1/2-13 Pistons
- ⊗ Air Inlet 1/4 N.P.T.
- ⊙ No Alignment Specified-Center Stud Mounting is Standard
- ⊗ Combination Stud/Air Inlet Stud Outside Thread is 3/4-16
- ⊙ Studs Inside Thread (Air Inlet) is 1/4 N.P.T. Exceptions Will Be Noted on Part View as ⊗

1T - Reversible Sleeve

BELLOW NO. ASSEMBLY ORDER NO.	CROSS SECTION VIEW	BEAD PLATE TOP VIEW	PISTON BOTTOM VIEW	ASSEMBLY WEIGHT (lbs.)	REPLACES
1T14C-7 W01-358-5426			 Order No. WC1-358-0686	9.3	Granning 6117
1T14C-7 W01-358-5702			 Order No. WC1-358-1603	10.3	Granning 8609
1T14C-7 W01-358-5712			 Order No. WC1-358-0600	7.1	Capacity of Texas
1T14C-8 W01-358-5429			 Order No. WC1-358-1603	10.3	Silent Drive
1T15AA-3 W01-358-9043 OBSOLETE Replaced by W01-358-9652			 Order No. WC1-358-0661		Mack 57QL1115 Hendrickson Trailer S-14147

1T Style Springs

**OBSOLETE
NO LONGER AVAILABLE**

Hardware Key

- Bolt or Stud 1/2-13 ⊗ Threaded Hole 3/8-16 Blind Nut on Bead Plates 1/2-13 Pistons ⊗ Air Inlet 1/4 N.P.T. No Alignment Specified-Center Stud Mounting is Standard
- ⊗ Combination Stud/Air Inlet Stud Outside Thread is 3/4-16 Studs Inside Thread (Air Inlet) is 1/4 N.P.T. Exceptions Will Be Noted on Part View as ⊗

Firestone

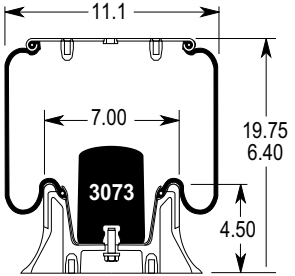
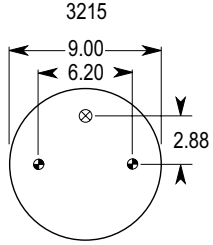
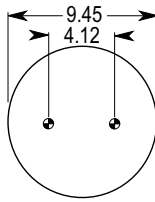
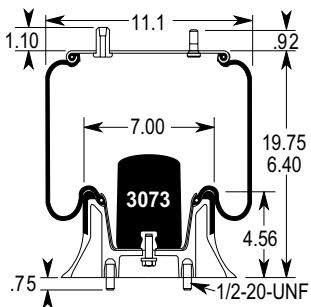
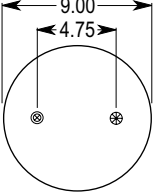
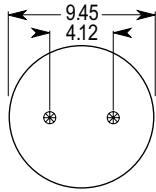
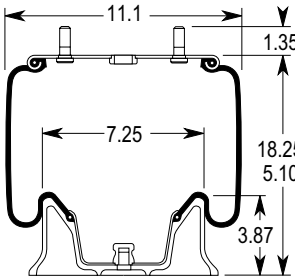
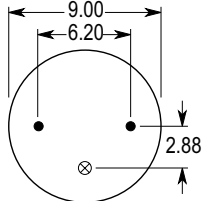
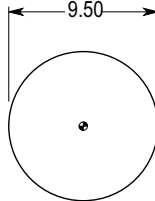
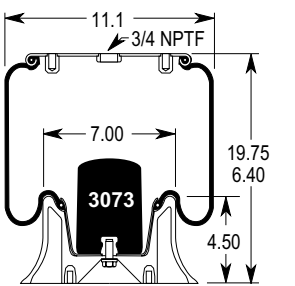
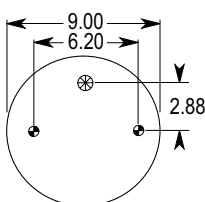
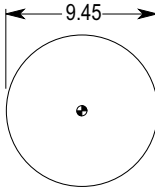
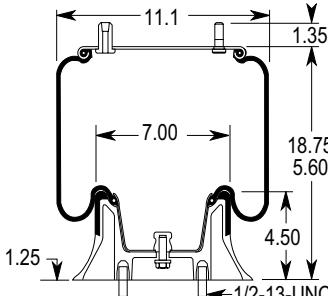
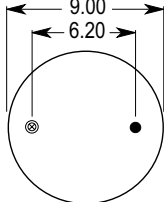
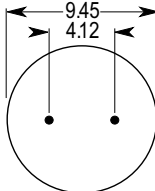
BELLOW NO. ASSEMBLY ORDER NO.	CROSS SECTION VIEW	BEAD PLATE TOP VIEW	PISTON BOTTOM VIEW	ASSEMBLY WEIGHT (lbs.)	REPLACES
1T15LP-3 W01-358-9049			 Order No. N/A	13.6	East Mfg. Granning 6252
1T15LP-3 W01-358-9073			 Order No. WC1-358-0661	15.9	Circle R Kenworth K-102-A Hendrickson Trailer S-7193 Ridewell 1003589073C REPLACEMENT PISTON COMES WITHOUT STUDS
1T15AA-3 W01-358-9076			 Order No. N/A	13.6	Pezzani
1T15AA-3 W01-358-9259			 Order No. N/A	14.3	Jet Co. (replace 9255) (11.00max. OD) Bolt removed for center mounting
1T15LP-3 W01-358-9285			 Order No. N/A	13.6	Hendrickson Trailer S-7364 REPLACEMENT PISTON COMES WITHOUT STUDS

Hardware Key

- Bolt or Stud 1/2-13
- ⊙ Threaded Hole 3/8-16 Blind Nut on Bead Plates 1/2-13 Pistons
- ⊗ Air Inlet 1/4 N.P.T.
- ⊕ No Alignment Specified-Center Stud Mounting is Standard
- ⊗ Combination Stud/Air Inlet Stud Outside Thread is 3/4-16
- ⊕ Studs Inside Thread (Air Inlet) is 1/4 N.P.T. Exceptions Will Be Noted on Part View as ⊕

1T - Reversible Sleeve

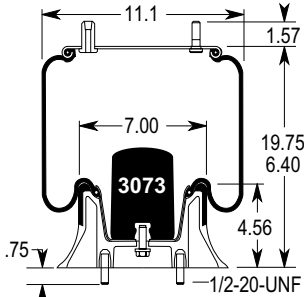
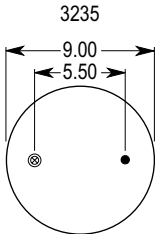
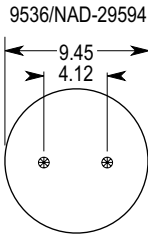
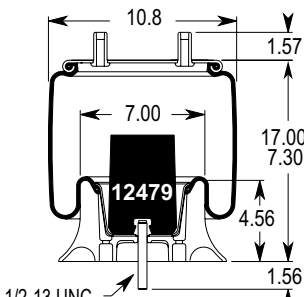
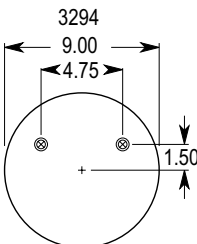
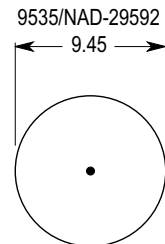
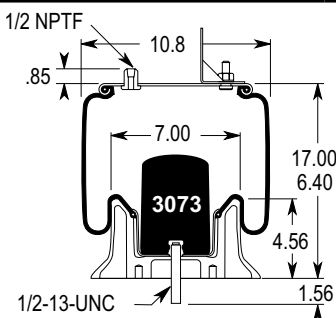
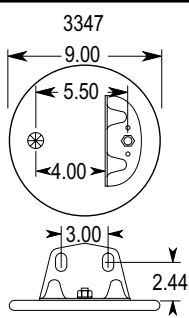
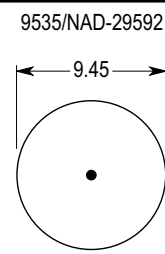
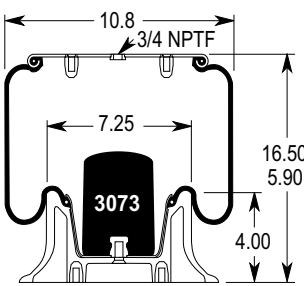
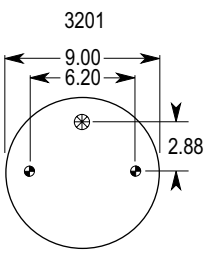
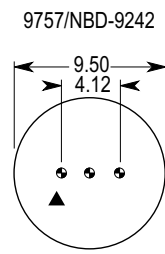
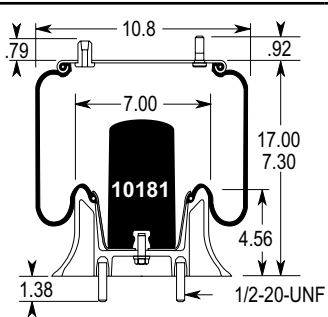
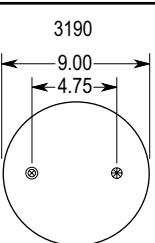
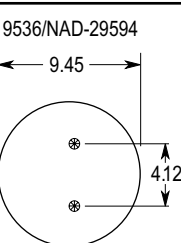
BELLOW NO. ASSEMBLY ORDER NO.	CROSS SECTION VIEW	BEAD PLATE TOP VIEW	PISTON BOTTOM VIEW	ASSEMBLY WEIGHT (lbs.)	REPLACES
1T15LP-3 W01-358-9290			 Order No. WC1-358-0755	15.9	American Carrier 8003-025 (supercedes 9234) Ridewell 1003589290C Peerless REPLACEMENT PISTON COMES WITHOUT STUDS
1T15LP-3 W01-358-9553			 Order No. N/A	15.9	Arvin Meritor A-2258-J-1466 WCC Rear RV
1T15LP-3 W01-358-9587			 Order No. N/A	13.9	Holland (Neway) 90557248 (replaces 90557220-1/20NPT flush) - ref. W01-358-9597
1T15AA-3 W01-358-9589			 Order No. N/A	N/A	Peterbilt 03-01686 Peterbilt 03-08424 - replaces W01-358-9146 (1T15S-6)
1T15LP-3 W01-358-9592			 Order No. WC1-358-0755	13.9	General Coach

1T Style Springs

Hardware Key

- Bolt or Stud 1/2-13 ⊗ Threaded Hole 3/8-16 Blind Nut on Bead Plates 1/2-13 Pistons ⊗ Air Inlet 1/4 N.P.T. No Alignment Specified-Center Stud Mounting is Standard
- ⊗ Combination Stud/Air Inlet Stud Outside Thread is 3/4-16 Studs Inside Thread (Air Inlet) is 1/4 N.P.T. Exceptions Will Be Noted on Part View as ⊗

Firestone

BELLOW NO. ASSEMBLY ORDER NO.	CROSS SECTION VIEW	BEAD PLATE TOP VIEW	PISTON BOTTOM VIEW	ASSEMBLY WEIGHT (lbs.)	REPLACES
1T15LP-3 W01-358-9597 BRACKET WC1-358-3887			9535/NAD-29592 Order No. N/A	13.9	Holland (Neway) 90557172 (AD-200) - ref. 90557220 90557248 (1/20NPT)
1T15S-6 W01-358-9599			9514/NAD-18158 Order No. N/A	16.3	Holland (Neway) 90557094 (ARD sus- pensions) - reference 90557128 (bead plate-3215) Holland (Neway) 90557128
1T15LP-3 W01-358-9652			9534/NAD-29634 Order No. N/A	13.6	Mack 57QL1115 Hendrickson Trailer S14147 Supercedes W01- 358-9043
1T15LP-3 W01-358-9953			9535/NAD-29592 Order No. N/A	14.3	Air AX (Roelofs)
1T15AA-6 W01-358-8965			9536/NAD-29594 Order No. WC1-358-0755	N/A	Granning 6057

Hardware Key

- Bolt or Stud 1/2-13 ● Threaded Hole 3/8-16 Blind Nut on Bead Plates 1/2-13 Pistons ⊗ Air Inlet 1/4 N.P.T. No Alignment Specified-Center Stud Mounting is Standard
- ⊗ Combination Stud/Air Inlet Stud Outside Thread is 3/4-16 Studs Inside Thread (Air Inlet) is 1/4 N.P.T. Exceptions Will Be Noted on Part View as ⊗

1T - Reversible Sleeve

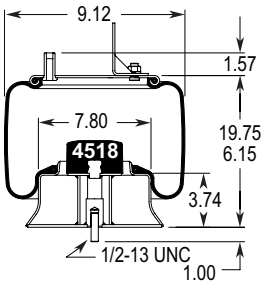
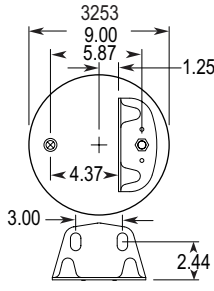
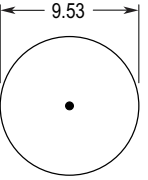
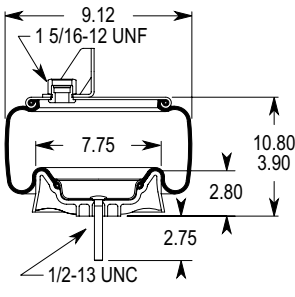
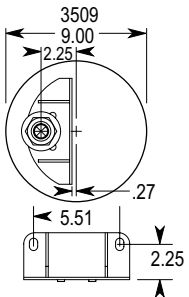
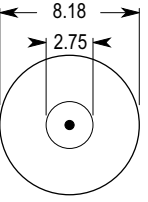
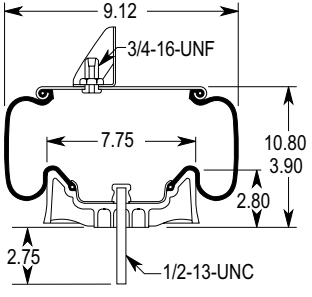
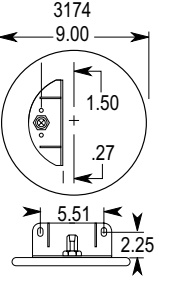
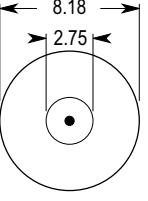
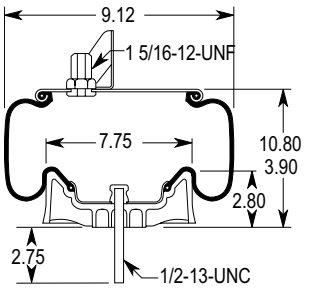
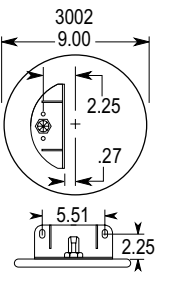
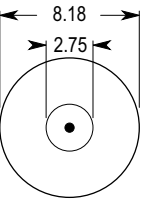
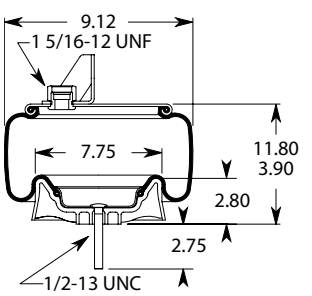
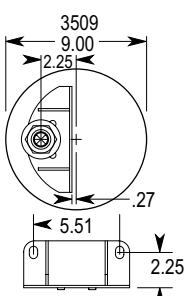
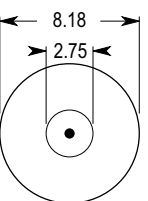
BELLOW NO. ASSEMBLY ORDER NO.	CROSS SECTION VIEW	BEAD PLATE TOP VIEW	PISTON BOTTOM VIEW	ASSEMBLY WEIGHT (lbs.)	REPLACES
1T15CCR-6 W01-358-8184			9645/NAD-31622  Order No. N/A	20.3	Neway 90557290 (RL228, KL230) Neway 90557308 (Same except piston Stud length 1.5 W01-358-8182)
1T15LA-(-1) W01-358-9547			9569/NAD-27754  Order No. WC1-358-1629	11.2	Kenworth C81-1004 Airglide 200 05/05/03 or later Airglide 400
1T15LA-(-1) W01-358-9617 BRACKET WC1-358-3892			9569/NAD-27754  Order No. WC1-358-1629	11.2	Kenworth K-303-18(Airglide 200) - small air fitting - original design (1996 & 1997 prod.) - replaced by K - 303-22(9622)
1T15LA-(-1) W01-358-9622 BRACKET WC1-358-3894			9569/NAD-27754  Order No. WC1-358-1629	11.0	Kenworth K-303-22 (Airglide 200-1998 to 5-5-03) - (large air fitting with interconnected airsprings)
1T15LA-0 W01-358-9541 BRACKET WC1-358-3890			9569/NAD-27754  Order No. WC1-358-1629	11.5	Kenworth C81-1005 Airglide 200 05/05/03 or later Airglide 460 Airglide 690

1T Style Springs

Hardware Key

- Bolt or Stud 1/2-13 ● Threaded Hole 3/8-16 Blind Nut on Bead Plates 1/2-13 Pistons ⊗ Air Inlet 1/4 N.P.T. No Alignment Specified-Center Stud Mounting is Standard
- ⊗ Combination Stud/Air Inlet Stud Outside Thread is 3/4-16 Studs Inside Thread (Air Inlet) is 1/4 N.P.T. Exceptions Will Be Noted on Part View as ⊗

Firestone

BELLOW NO. ASSEMBLY ORDER NO.	CROSS SECTION VIEW	BEAD PLATE TOP VIEW	PISTON BOTTOM VIEW	ASSEMBLY WEIGHT (lbs.)	REPLACES
1T15LA-0 W01-358-9618 BRACKET WC1-358-3892			9569/NAD-27754 Order No. WC1-358-1629	13.5	Kenworth K-303-19 (Airglide 200) 46,000# - small air fitting - -1996 & 97 prod. - replaced by K-303-25(9625)
1T15LA-0 W01-358-9625 BRACKET WC1-358-3890			9569/NAD-27754 Order No. WC1-358-1629	13.5	Kenworth K-303-25 (Airglide 200-46,000#, 1998 & later prod.)
1T15LA-0 W01-358-9675 BRACKET WC1-358-3890			9569/NAD-27754 Order No. WC1-358-1629	11.6	Kenworth K-303-28 Airglide 200 Before 05/05/03
1T15L-1.5 W01-358-8886			9572/NAD-18161 Order No. N/A	11.5	Dexter Axle 034-279-00
1T15L-1.5 W01-358-9422			9571/NAD-18130 Order No. WC1-358-0646	10.0	Kenworth K303-6 Kenworth K303-14 Kenworth K303-15 (Airglide 100) -older version with no bracket

Hardware Key

- Bolt or Stud 1/2-13 ● Threaded Hole 3/8-16 Blind Nut on Bead Plates 1/2-13 Pistons ⊗ Air Inlet 1/4 N.P.T. No Alignment Specified-Center Stud Mounting is Standard
- ⊗ Combination Stud/Air Inlet Stud Outside Thread is 3/4-16 Studs Inside Thread (Air Inlet) is 1/4 N.P.T. Exceptions Will Be Noted on Part View as ⊗

1T - Reversible Sleeve

BELLOW NO. ASSEMBLY ORDER NO.	CROSS SECTION VIEW	BEAD PLATE TOP VIEW	PISTON BOTTOM VIEW	ASSEMBLY WEIGHT (lbs.)	REPLACES
1T15L-1.5 W01-358-9584			<p>Order No. WC1-358-0647</p>	12.1	Neway 90557250 (replaces W01-675-9613, 90557224-flush fitting)
1T15L-1.5 W01-358-9616 BRACKET WC1-358-3893			<p>Order No. WC1-358-0646</p>	11.2	K-303-16 (Airglide 100)
1T15LP-1.5 W01-358-8597			<p>Order No. WC1-358-0683</p>	14.6	Hendrickson Truck 65790-2
1T15L-2 W01-358-8900			<p>Order No. WC1-358-0663</p>	13.0	Reyco 17361-01
1T15L-2 W01-358-8901			<p>Order No. WC1-358-1616</p>	11.6	Ridwell 1003588901C

1T Style Springs

Hardware Key

- Bolt or Stud 1/2-13 ● Threaded Hole 3/8-16 Blind Nut on Bead Plates 1/2-13 Pistons ⊗ Air Inlet 1/4 N.P.T. No Alignment Specified-Center Stud Mounting is Standard
- ⊗ Combination Stud/Air Inlet Stud Outside Thread is 3/4-16 Studs Inside Thread (Air Inlet) is 1/4 N.P.T. Exceptions Will Be Noted on Part View as ⊗

Firestone

BELLOW NO. ASSEMBLY ORDER NO.	CROSS SECTION VIEW	BEAD PLATE TOP VIEW	PISTON BOTTOM VIEW	ASSEMBLY WEIGHT (lbs.)	REPLACES
1T15L-2 W01-358-9075				14.1	Hutchen H-2007 Holland (Neway) 90557030 Pezzani Order No. WC1-358-0653
1T15L-2 W01-358-9376				11.8	Monaco Coach 8619 Monaco Coach W01-358-8897 with 3/4 NPT Order No. WC1-358-0646
1T15L-2 W01-358-9377				11.4	Reyco 21054-01 Order No. WC1-358-0646
1T15L-2 W01-358-9378				11.7	Ridewell 1003589378C Order No. WC1-358-0646
1T15L-2 W01-358-9387				10.4	Ridewell 1003589387C

Hardware Key

- Bolt or Stud 1/2-13
- ⊙ Threaded Hole 3/8-16 Blind Nut on Bead Plates 1/2-13 Pistons
- ⊗ Air Inlet 1/4 N.P.T.
- ⊕ No Alignment Specified-Center Stud Mounting is Standard
- ⊗ Combination Stud/Air Inlet Stud Outside Thread is 3/4-16
- ⊙ Studs Inside Thread (Air Inlet) is 1/4 N.P.T. Exceptions Will Be Noted on Part View as ⊗

1T - Reversible Sleeve

BELLOW NO. ASSEMBLY ORDER NO.	CROSS SECTION VIEW	BEAD PLATE TOP VIEW	PISTON BOTTOM VIEW	ASSEMBLY WEIGHT (lbs.)	REPLACES
1T15L-2 W01-358-9440			 Order No. WC1-358-9454	13.2	Madsen (replaces 9014)
1T15L-2 W01-358-9445			 Order No. WC1-358-0683	14.3	Ridewell 1003589445C REPLACEMENT PISTON COMES WITHOUT STUDS
1T15L-2 W01-358-9447			 Order No. WC1-358-0683	14.1	Ridewell 1003589447C
1T15L-2 W01-358-9448			 Order No. WC1-358-0683	14.0	Ridewell 1003589448C Foretravel Inc. REPLACEMENT PISTON COMES WITHOUT STUDS
1T15L-2 W01-358-9457			 Order No. WC1-358-0683	14.0	Ridewell 1003589457C REPLACEMENT PISTON COMES WITHOUT STUDS

1T Style Springs

Hardware Key

- Bolt or Stud 1/2-13 ⊗ Threaded Hole 3/8-16 Blind Nut on Bead Plates 1/2-13 Pistons ⊗ Air Inlet 1/4 N.P.T. No Alignment Specified-Center Stud Mounting is Standard
- ⊗ Combination Stud/Air Inlet Stud Outside Thread is 3/4-16 Studs Inside Thread (Air Inlet) is 1/4 N.P.T. Exceptions Will Be Noted on Part View as ⊗

Firestone

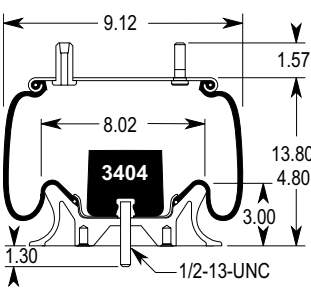
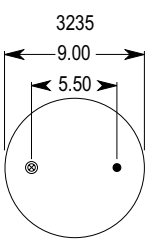
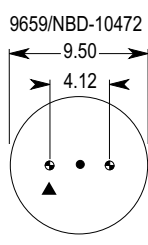
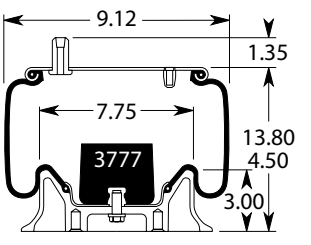
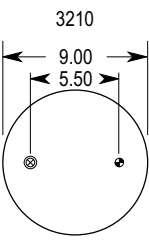
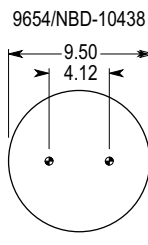
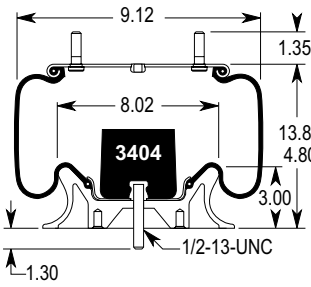
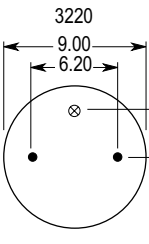
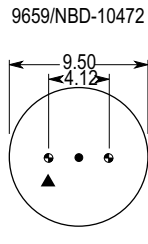
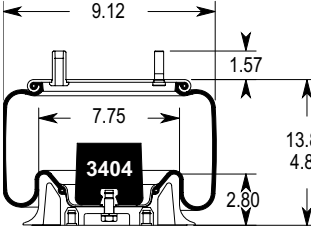
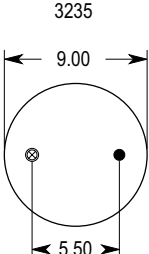
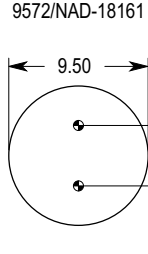
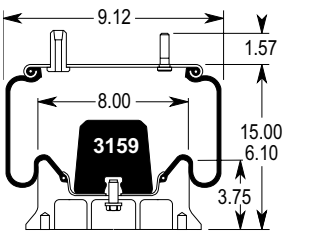
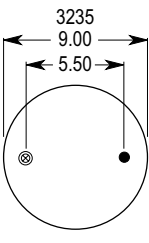
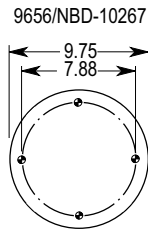
BELLOW NO. ASSEMBLY ORDER NO.	CROSS SECTION VIEW	BEAD PLATE TOP VIEW	PISTON BOTTOM VIEW	ASSEMBLY WEIGHT (lbs.)	REPLACES
1T15L-2 W01-358-9459				14.0	Ridewell 1003589459C ArvinMeritor A-2258-U-1451 RFA23ER-RV
1T15L-2 W01-358-9476				13.0	Reyco 20446-01
1T15L-2 W01-358-9477				13.7	Ridewell 1003589477C
1T15L-2 W01-358-9562				11.6	Link 1103-0501 Lifttable
1T15LP-2 W01-358-8958				15.1	Granning 6978

Hardware Key

- Bolt or Stud 1/2-13
- ⊙ Threaded Hole 3/8-16 Blind Nut on Bead Plates 1/2-13 Pistons
- ⊗ Air Inlet 1/4 N.P.T.
- ⊕ No Alignment Specified-Center Stud Mounting is Standard
- ⊗ Combination Stud/Air Inlet Stud Outside Thread is 3/4-16
- ⊕ Studs Inside Thread (Air Inlet) is 1/4 N.P.T. Exceptions Will Be Noted on Part View as ⊗

1T - Reversible Sleeve

BELLOW NO. ASSEMBLY ORDER NO.	CROSS SECTION VIEW	BEAD PLATE TOP VIEW	PISTON BOTTOM VIEW	ASSEMBLY WEIGHT (lbs.)	REPLACES
1T15LP-2 W01-358-8959 BRACKET 70-3582-6036			9549/NAD-29454 Order No. WC1-358-1616	10.5	Reyco 20773-01
1T15LP-2 W01-358-9554 METRIC			9569/NAD-27754 Order No. WC1-358-1629	11.2	Hendrickson 60716-2
1T15LP-2 W01-358-9681			9572/NAD-18161 Order No. N/A	9.8	Link 1103-0508
1T15LC-2.5 W01-358-9565			9663/NBD-12639 Order No. N/A	12.0	Navistar 2027912C1 (GY 1R12-324)
1T15LC-2.5 W01-358-9566			9663/NBD-12639 Order No. N/A	12.0	Navistar 1672401C1 (GY 1R12-204)

1T Style Springs

Hardware Key

- Bolt or Stud 1/2-13 ● Threaded Hole 3/8-16 Blind Nut on Bead Plates 1/2-13 Pistons ⊗ Air Inlet 1/4 N.P.T. No Alignment Specified-Center Stud Mounting is Standard
- ⊗ Combination Stud/Air Inlet Stud Outside Thread is 3/4-16 Studs Inside Thread (Air Inlet) is 1/4 N.P.T. Exceptions Will Be Noted on Part View as ⊗

Firestone

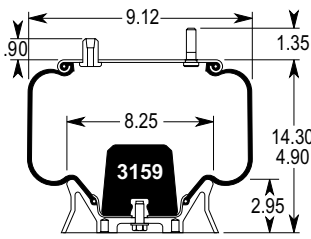
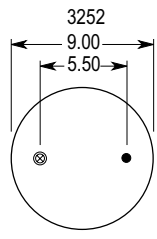
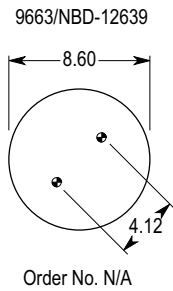
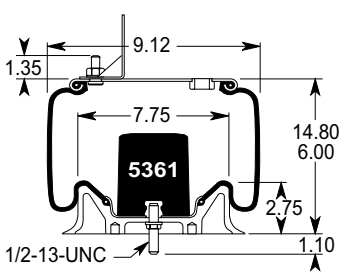
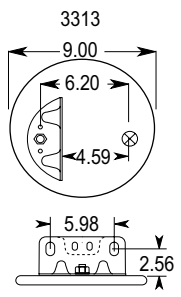
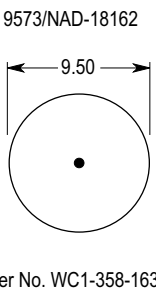
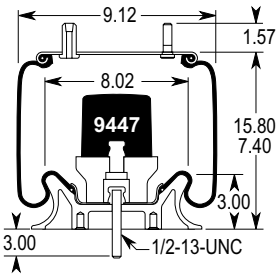
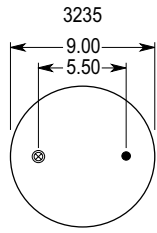
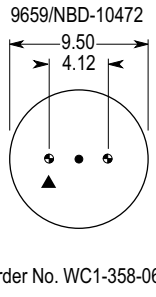
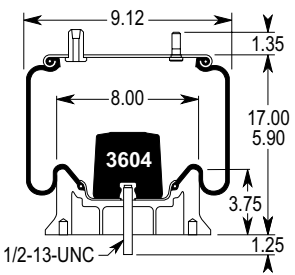
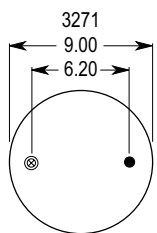
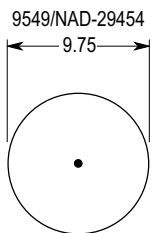
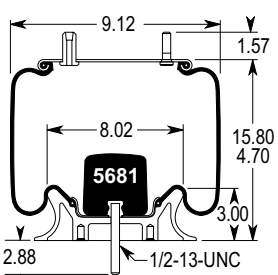
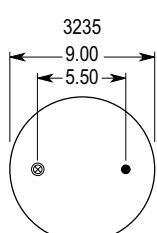
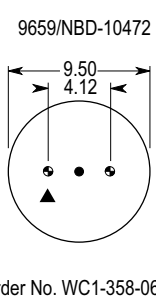
BELLOW NO. ASSEMBLY ORDER NO.	CROSS SECTION VIEW	BEAD PLATE TOP VIEW	PISTON BOTTOM VIEW	ASSEMBLY WEIGHT (lbs.)	REPLACES
1T15LC-2.5 W01-358-9379			9663/NBD-12639 	13.6	Navistar (U-Haul) 1660694C-1
1T15L-3 W01-358-9284 BRACKET WC1-358-9284			9573/NAD-18162 	12.3	Hendrickson 56916 (class 6 Freightliner) -not current production - ref 56917 (W01-358-9335)
1T15L-4 W01-358-8918			9659/NBD-10472 	15.4	Granning 7692
1T15L-4 W01-358-8919			9549/NAD-29454 	13.0	Ridewell 1003588919C
1T15L-4 W01-358-8922			9659/NBD-10472 	13.6	Granning 5492 Granning 5385 (no stud)

Hardware Key

- Bolt or Stud 1/2-13
- ⊙ Threaded Hole 3/8-16 Blind Nut on Bead Plates 1/2-13 Pistons
- ⊗ Air Inlet 1/4 N.P.T.
- ⊕ No Alignment Specified-Center Stud Mounting is Standard
- ⊗ Combination Stud/Air Inlet Stud Outside Thread is 3/4-16
- ⊕ Studs Inside Thread (Air Inlet) is 1/4 N.P.T. Exceptions Will Be Noted on Part View as ⊗

1T - Reversible Sleeve

BELLOW NO. ASSEMBLY ORDER NO.	CROSS SECTION VIEW	BEAD PLATE TOP VIEW	PISTON BOTTOM VIEW	ASSEMBLY WEIGHT (lbs.)	REPLACES
1T15L-4 W01-358-8942 BRACKET WC1-358-3904			9549/NAD-29454 Order No. WC1-358-1616	14.4	Hendrickson 58983-2 (Blue Bird)
1T15L-4 W01-358-8951			9659/NBD-10472 Order No. WC1-358-0683	12.9	Reyco 19624-01 REPLACEMENT PISTON COMES WITHOUT STUDS
1T15L-4 W01-358-9415 SERVICE ASSEMBLY W01-358-0701			9691/NBD-14503 Order No. WC1-358-0606	15.7	Kenworth K-303-5 Replacement piston comes without studs
1T15L-4 W01-358-9438			9743/NBD-8183 Order No. WC1-358-0653	14.6	Waggoner's Truck
1T15L-4 W01-358-9439			9656/NBD-10267 Order No. WC1-358-0652	14.5	Waggoner's Truck Hagie Mfg.

1T Style Springs

Hardware Key

- Bolt or Stud 1/2-13 ● Threaded Hole 3/8-16 Blind Nut on Bead Plates 1/2-13 Pistons ⊗ Air Inlet 1/4 N.P.T. No Alignment Specified-Center Stud Mounting is Standard
- ⊗ Combination Stud/Air Inlet Stud Outside Thread is 3/4-16 Studs Inside Thread (Air Inlet) is 1/4 N.P.T. Exceptions Will Be Noted on Part View as ⊗

Firestone

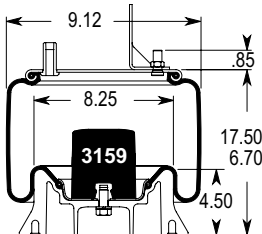
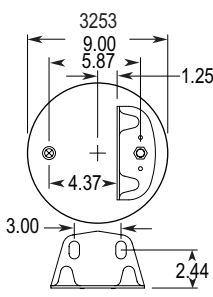
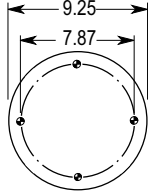
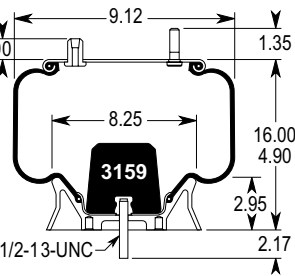
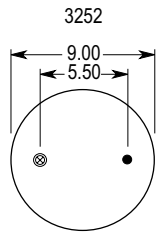
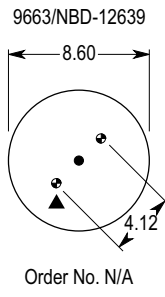
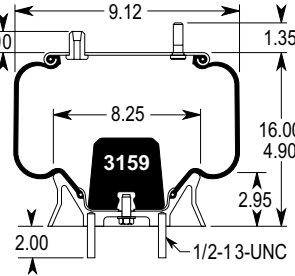
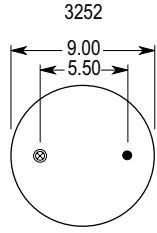
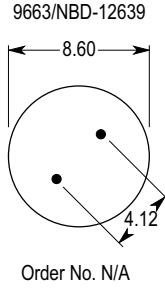
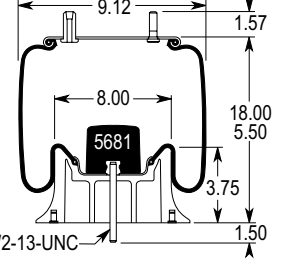
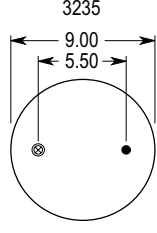
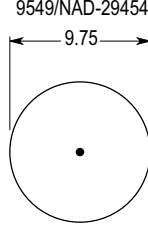
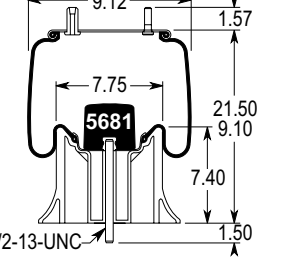
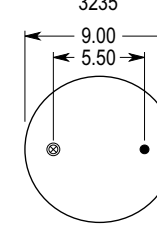
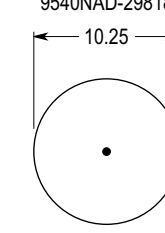
BELLOW NO. ASSEMBLY ORDER NO.	CROSS SECTION VIEW	BEAD PLATE TOP VIEW	PISTON BOTTOM VIEW	ASSEMBLY WEIGHT (lbs.)	REPLACES
1T15L-4 W01-358-9855				15.7	Holland 90557354 Replaces 90557284
1T15LC-4.5 W01-358-9567				14.1	Navistar 2027913C1 (GY 1R12-325)
1T15LC-4.5 W01-358-9568				14.5	Navistar 1675495C1 (GY 1R12-205)
1T15LP-5 W01-358-8949				12.8	Holland (Neway) 90557150
1T15LP-5 W01-358-9291				14.7	Holland (Neway) 90557139 (RL196-17) (RL196A-17) - replaces 90557122 - originally 1T15M-4 bellows

Hardware Key

- Bolt or Stud 1/2-13
- ⊙ Threaded Hole 3/8-16 Blind Nut on Bead Plates 1/2-13 Pistons
- ⊗ Air Inlet 1/4 N.P.T.
- ⊕ No Alignment Specified-Center Stud Mounting is Standard
- ⊗ Combination Stud/Air Inlet Stud Outside Thread is 3/4-16
- ⊗ Studs Inside Thread (Air Inlet) is 1/4 N.P.T. Exceptions Will Be Noted on Part View as ⊗

1T - Reversible Sleeve

BELLOW NO. ASSEMBLY ORDER NO.	CROSS SECTION VIEW	BEAD PLATE TOP VIEW	PISTON BOTTOM VIEW	ASSEMBLY WEIGHT (lbs.)	REPLACES
1T15LP-5 W01-358-9293				12.9	Holland (Neway) 90557120 (RL196-14, RL196A-14)
1T15LP-5 W01-358-9294				11.4	Holland (Neway) 90557127 (RL-196-12)
1T15LP-5 W01-358-9295				13.2	Holland (Neway) 90557121 (RL196-15 & 16) (RL196A-15 & 16)
1T15L-6 W01-358-9626				13.4	Hendrickson Trailer S23720
1T15LP-6 W01-358-9015 OBSOLETE REPLACED BY W01-358-8944 1T15MLW-7				17.8	Hendrickson Trailer S20217 (HT-190U) - superseded by W01-358-8944 1T15MLW-7

1T Style Springs

**OBSOLETE
NO LONGER AVAILABLE**

Hardware Key

- Bolt or Stud 1/2-13 ⊗ Threaded Hole 3/8-16 Blind Nut on Bead Plates 1/2-13 Pistons ⊗ Air Inlet 1/4 N.P.T. No Alignment Specified-Center Stud Mounting is Standard
- ⊗ Combination Stud/Air Inlet Stud Outside Thread is 3/4-16 Studs Inside Thread (Air Inlet) is 1/4 N.P.T. Exceptions Will Be Noted on Part View as ⊗

Firestone

BELLOW NO. ASSEMBLY ORDER NO.	CROSS SECTION VIEW	BEAD PLATE TOP VIEW	PISTON BOTTOM VIEW	ASSEMBLY WEIGHT (lbs.)	REPLACES
1T15L-9 W01-358-9559			9532/NAD-29827 Order No. WC1-358-1619	13.7	Reyco 25437-01
1T15L-9 W01-358-9560			9530/NAD-27809 Order No. WC1-358-9452	14.1	Reyco 25396-01
1T15LB-10 W01-358-9621			9532/NAD-29827 Order No. WC1-358-1619	14.5	Hendrickson Trailer S23613
1T15LC-12 W01-358-9619			9540/NAD-29828 Order No. WC1-358-0664	16.2	Hendrickson Trailer S23614
1T15M-0 W01-358-8961			9572/NAD-18161 Order No. N/A	10.1	Reyco 23377-01

Hardware Key

- Bolt or Stud 1/2-13
- ⊕ Threaded Hole 3/8-16 Blind Nut on Bead Plates 1/2-13 Pistons
- ⊗ Air Inlet 1/4 N.P.T.
- ⊙ No Alignment Specified-Center Stud Mounting is Standard
- ⊗ Combination Stud/Air Inlet Stud Outside Thread is 3/4-16
- ⊙ Studs Inside Thread (Air Inlet) is 1/4 N.P.T. Exceptions Will Be Noted on Part View as ⊗

1T - Reversible Sleeve

BELLOW NO. ASSEMBLY ORDER NO.	CROSS SECTION VIEW	BEAD PLATE TOP VIEW	PISTON BOTTOM VIEW	ASSEMBLY WEIGHT (lbs.)	REPLACES
1T15M-0 W01-358-8963			 Order No. WC1-358-9454	13.2	Ridewell 1003588963C
1T15M-0 W01-358-8964			 Order No. WC1-358-0646	11.6	Reyco 21598-01
1T15M-0 W01-358-8971			 Order No. WC1-358-1634	10.1	Hendrickson 59484-2 (Blue Bird)
1T15M-0 W01-358-8972			 Order No. WC1-358-1634	11.2	Hendrickson 59601-2
1T15M-0 W01-358-8976			 Order No. WC1-358-0646	11.1	Reyco 21055-01

1T Style Springs

Hardware Key

- Bolt or Stud 1/2-13 ● Threaded Hole 3/8-16 Blind Nut on Bead Plates 1/2-13 Pistons ⊗ Air Inlet 1/4 N.P.T. No Alignment Specified-Center Stud Mounting is Standard
- ⊗ Combination Stud/Air Inlet Stud Outside Thread is 3/4-16 Studs Inside Thread (Air Inlet) is 1/4 N.P.T. Exceptions Will Be Noted on Part View as ⊗

Firestone

BELLOW NO. ASSEMBLY ORDER NO.	CROSS SECTION VIEW	BEAD PLATE TOP VIEW	PISTON BOTTOM VIEW	ASSEMBLY WEIGHT (lbs.)	REPLACES
1T15M-0 W01-358-8986			<p>Order No. WC1-358-0646</p>	11.5	Ridewell 1003588986C
1T15M-0 W01-358-9029			<p>Order No. WC1-358-0646</p>	11.6	Ridewell 1003589029C
1T15M-0 W01-358-9031			<p>Order No. WC1-358-0663</p>	13.0	Peerless 0550-00051
1T15M-0 W01-358-9033 SERVICE ASSEMBLY W01-358-0727			<p>Order No. WC1-358-9454</p>	13.4	Holland (Neway) 90557012 Mfg.SV.# Holland (Neway) 90044198
1T15M-0 W01-358-9036			<p>Order No. WC1-358-0663</p>	13.4	Willmar

Hardware Key

- Bolt or Stud 1/2-13
- ⊙ Threaded Hole 3/8-16 Blind Nut on Bead Plates 1/2-13 Pistons
- ⊗ Air Inlet 1/4 N.P.T.
- ⊕ No Alignment Specified-Center Stud Mounting is Standard
- ⊗ Combination Stud/Air Inlet Stud Outside Thread is 3/4-16
- ⊕ Studs Inside Thread (Air Inlet) is 1/4 N.P.T. Exceptions Will Be Noted on Part View as ⊗

1T - Reversible Sleeve

BELLOW NO. ASSEMBLY ORDER NO.	CROSS SECTION VIEW	BEAD PLATE TOP VIEW	PISTON BOTTOM VIEW	ASSEMBLY WEIGHT (lbs.)	REPLACES
1T15M-0 W01-358-9039 SEVICE ASSEMBLY W01-358-0702				13.4	Hendrickson Trailer S2064/S11650 Holland (Neway) 90557001 Holland (Neway) 90557023 Holland (Neway) 90557085 Hutchens H-9424-01 R & S Truck & Body 1090218 Ridewell 1013589039C FabTek 101827 Sauer P50-734 Watson & Chalin AS-0012
1T15M-0 W01-358-9077				13.2	Fruehauf UCB-44531 Fruehauf MFR 022354
1T15M-0 W01-358-9308				13.0	Reyco 17360-01 Holland (Neway) 90557089 (remove bolt)
1T15M-0 W01-358-9332				11.3	Reyco 20074-01
1T15M-0 W01-358-9333				12.8	Reyco 20437-01

1T Style Springs

Hardware Key

- Bolt or Stud 1/2-13 ● Threaded Hole 3/8-16 Blind Nut on Bead Plates 1/2-13 Pistons ⊗ Air Inlet 1/4 N.P.T. No Alignment Specified-Center Stud Mounting is Standard
- ⊗ Combination Stud/Air Inlet Stud Outside Thread is 3/4-16 Studs Inside Thread (Air Inlet) is 1/4 N.P.T. Exceptions Will Be Noted on Part View as ⊗

Firestone

BELLOW NO. ASSEMBLY ORDER NO.	CROSS SECTION VIEW	BEAD PLATE TOP VIEW	PISTON BOTTOM VIEW	ASSEMBLY WEIGHT (lbs.)	REPLACES
1T15M-0 W01-358-9334			<p>Order No. WC1-358-0663</p>	12.9	Ridewell 1003589334C
1T15M-0 W01-358-9505			<p>Order No. WC1-358-0647</p>	10.4	Holland (Neway) 90557312 Freightliner Custom Chassis
1T15M-1 W01-358-8882 OBSOLETE REPLACED BY W01-358-9807 SPACER NEEDED				10.9	Holland 90557306 CB-4000
1T15M-2 W01-358-9807				11.0	Spacer Options: WC1-358-1690 WC1-358-1691 WC1-358-1692 (see specs for each following)
WC1-358-1690					Use with Neway CB-4000 W01-358-9807 Ride Height 15.5 & 16

Hardware Key

- Bolt or Stud 1/2-13 ● Threaded Hole 3/8-16 Blind Nut on Bead Plates 1/2-13 Pistons ⊗ Air Inlet 1/4 N.P.T. No Alignment Specified-Center Stud Mounting is Standard
- ⊗ Combination Stud/Air Inlet Stud Outside Thread is 3/4-16 Studs Inside Thread (Air Inlet) is 1/4 N.P.T. Exceptions Will Be Noted on Part View as ⊗

1T - Reversible Sleeve

BELLOW NO. ASSEMBLY ORDER NO.	CROSS SECTION VIEW	BEAD PLATE TOP VIEW	PISTON BOTTOM VIEW	ASSEMBLY WEIGHT (lbs.)	REPLACES
WC1-358-1691					Use with Neway CB-4000 W01-358-9807 Ride Height 16.5
WC1-358-1692					Use with Neway CB-4000 W01-358-9807 Ride Height 17
1T15M-1 W01-358-9307				10.2	Holland (Neway) 90557129 (AR-41, 45 & 45-1) (plastic)
1T15M-2 W01-358-7667				12.1	Holland (Neway) 90557256 IFS-114
1T15M-2 W01-358-8197				10.7	Holland (Neway) 90557230

1T Style Springs

Hardware Key

- Bolt or Stud 1/2-13 ⊗ Threaded Hole 3/8-16 Blind Nut on Bead Plates 1/2-13 Pistons ⊗ Air Inlet 1/4 N.P.T. No Alignment Specified-Center Stud Mounting is Standard
- ⊗ Combination Stud/Air Inlet Stud Outside Thread is 3/4-16 Studs Inside Thread (Air Inlet) is 1/4 N.P.T. Exceptions Will Be Noted on Part View as ⊗

Firestone

BELLOW NO. ASSEMBLY ORDER NO.	CROSS SECTION VIEW	BEAD PLATE TOP VIEW	PISTON BOTTOM VIEW	ASSEMBLY WEIGHT (lbs.)	REPLACES
1T15M-2 W01-358-8198			<p>Order No. WC1-358-1652</p>	13.3	Holland (Neway) 90557229 (IFS-114) - (center stud used for locating in pre- assembly)
1T15M-2 W01-358-8201			<p>Order No. WC1-358-1634</p>	10.5	Ridewell 1003588201C
1T15M-2 W01-358-8203			<p>Order No. WC1-358-1616</p>	13.1	Holland (Neway) 90557210 - (replaces W01-358-8987) Wabash Trailer ArvinMeritor 2258- C-1459
1T15M-2 W01-358-8204			<p>Order No. WC1-358-1634</p>	10.7	Holland (Neway) 90557173 (RL196A-12) Holland (Neway) 90557223 Binkley Newlite (NS 190-16)
1T15M-2 W01-358-8207			<p>Order No. WC1-358-1616</p>	11.4	Freightliner Custom Chassis 16- 16019-000

Hardware Key

- Bolt or Stud 1/2-13
- ⊙ Threaded Hole 3/8-16 Blind Nut on Bead Plates 1/2-13 Pistons
- ⊗ Air Inlet 1/4 N.P.T.
- ⊕ No Alignment Specified-Center Stud Mounting is Standard
- ⊗ Combination Stud/Air Inlet Stud Outside Thread is 3/4-16
- ⊕ Studs Inside Thread (Air Inlet) is 1/4 N.P.T. Exceptions Will Be Noted on Part View as ⊗

1T - Reversible Sleeve

BELLOW NO. ASSEMBLY ORDER NO.	CROSS SECTION VIEW	BEAD PLATE TOP VIEW	PISTON BOTTOM VIEW	ASSEMBLY WEIGHT (lbs.)	REPLACES
1T15M-2 W01- M58-8650 METRIC BRACKET WC1-358-3903			9573/NAD-18162 Order No. WC1-358-1634	12.5	Hendrickson 64403-2
1T15M-2 W01-358- 8878			9550/NAD-29456 Order No. WC1-358-1652	11.9	Arvin Meritor A- 2258-A-1483 (WCC Front RV)
1T15M-2 W01-358- 8930 SERVICE ASSEMBLY W01-358-0725			9727/NBD-8725 Order No. WC1-358-0651	14.1	Ridewell 1003588930C
1T15M-2 W01-358- 8931 METRIC			3822/NBD-10378 Order No. N/A	14.9	John Deere
1T15M-2 W01-358- 8932			9530/NAD-27809 Order No. WC1-358-9452	12.7	Reyco 22241-01

1T Style Springs

Hardware Key

- Bolt or Stud 1/2-13 ● Threaded Hole 3/8-16 Blind Nut on Bead Plates 1/2-13 Pistons ⊗ Air Inlet 1/4 N.P.T. No Alignment Specified-Center Stud Mounting is Standard
- ⊗ Combination Stud/Air Inlet Stud Outside Thread is 3/4-16 Studs Inside Thread (Air Inlet) is 1/4 N.P.T. Exceptions Will Be Noted on Part View as ⊗

Firestone

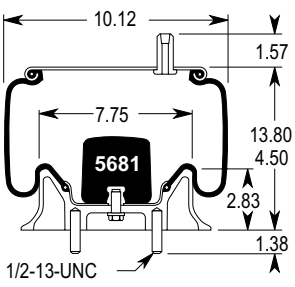
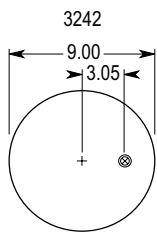
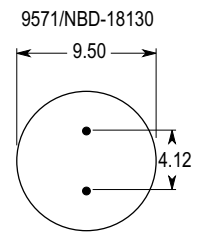
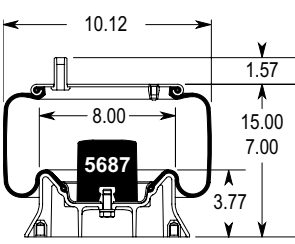
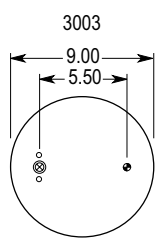
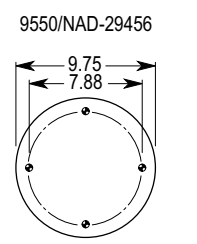
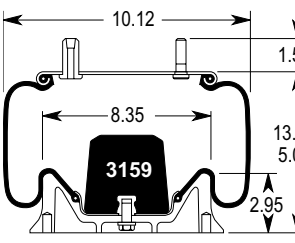
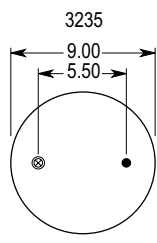
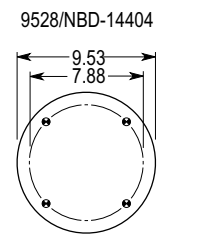
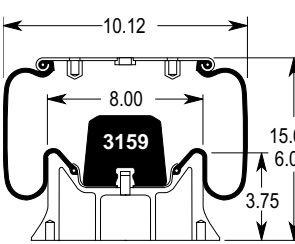
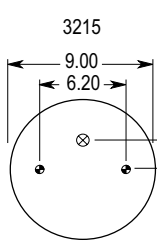
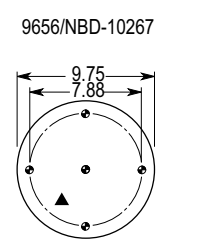
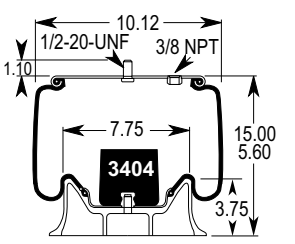
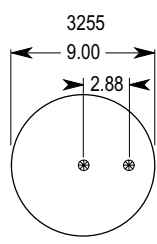
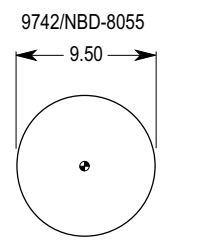
BELLOW NO. ASSEMBLY ORDER NO.	CROSS SECTION VIEW	BEAD PLATE TOP VIEW	PISTON BOTTOM VIEW	ASSEMBLY WEIGHT (lbs.)	REPLACES
1T15M-2 W01-358-8934			 Order No. WC1-358-0646	10.9	Hendrickson Trailer S20228
1T15M-2 W01-358-8935			 Order No. WC1-358-1652	12.1	Tuthill Reyco 23027-01
1T15M-2 W01-358-8991			 Order No. WC1-358-0667	12.7	Reyco 17414-01
1T15M-2 W01-358-9053			 Order No. WC1-358-0652	14.6	EZ Ride 8030192 Ridewell 1003589053C Fruehauf UCE-1304-2
1T15M-2 W01-358-9078			 Order No. WC1-358-0658	14.0	Fruehauf UCB-9668-1 Fruehauf MFR-022355

Hardware Key

- Bolt or Stud 1/2-13
- ⊙ Threaded Hole 3/8-16 Blind Nut on Bead Plates 1/2-13 Pistons
- ⊗ Air Inlet 1/4 N.P.T.
- ⊕ No Alignment Specified-Center Stud Mounting is Standard
- ⊗ Combination Stud/Air Inlet Stud Outside Thread is 3/4-16
- ⊕ Studs Inside Thread (Air Inlet) is 1/4 N.P.T. Exceptions Will Be Noted on Part View as ⊗

1T - Reversible Sleeve

BELLOW NO. ASSEMBLY ORDER NO.	CROSS SECTION VIEW	BEAD PLATE TOP VIEW	PISTON BOTTOM VIEW	ASSEMBLY WEIGHT (lbs.)	REPLACES
1T15M-2 W01-358-9105 SERVICE ASSEMBLY W01-358-0725				13.2	Hendrickson Trailer S1245 Granning 5065 Ridewell 1003589105C Watson & Chalin AS-0015
1T15M-2 W01-358-9113				14.6	Hendrickson
1T15M-2 W01-358-9118				14.3	Ridewell 1003589118C
1T15M-2 W01-358-9302 SERVICE ASSEMBLY W01-358-0725				13.2	Hendrickson Can. B-12514-003
1T15M-2 W01-358-9325				13.6	Holland (Neway) 90557149

1T Style Springs

Hardware Key

- Bolt or Stud 1/2-13 ⊗ Threaded Hole 3/8-16 Blind Nut on Bead Plates 1/2-13 Pistons ⊗ Air Inlet 1/4 N.P.T. No Alignment Specified-Center Stud Mounting is Standard
- ⊗ Combination Stud/Air Inlet Stud Outside Thread is 3/4-16 Studs Inside Thread (Air Inlet) is 1/4 N.P.T. Exceptions Will Be Noted on Part View as ⊗

Firestone

BELLOW NO. ASSEMBLY ORDER NO.	CROSS SECTION VIEW	BEAD PLATE TOP VIEW	PISTON BOTTOM VIEW	ASSEMBLY WEIGHT (lbs.)	REPLACES
1T15M-2 W01-358-9339 BRACKET 70-3582-6044			9573/NAD-18162 Order No. WC1-358-1634	12.0	Hendrickson 56808-2 (class 6 Ford) Hendrickson 57150 RH Hendrickson 57140 LH - Remove new bracket and reuse old (class 6 & 7 GM)
1T15M-2 W01-358-9365			9544/NAD-29826 Order No. WC1-358-0666	12.5	Holland (Neway) 90557159
1T15M-2 W01-358-9366			9549/NAD-29454 Order No. WC1-358-1616	11.8	Holland (Neway) 90557160 Holland (Neway) 90557210 Holland (Neway) 90557225 Watson & Chalin AS-0054 Wabash Holland (Neway) 90557225
1T15M-2 W01-358-9556			9550/NAD-29456 Order No. WC1-358-1652	14.8	Tuthill Granning 703180-01
1T15MR-2 W01-358-9268			 Order No. N/A	CUSTOMER SUPPLIED PISTON	Holland (Neway) 90557123 - Service assembly only (no piston) ARD120 & 240-5 (Air Beam) (90054540 w/o bracket)

Hardware Key

- Bolt or Stud 1/2-13 ● Threaded Hole 3/8-16 Blind Nut on Bead Plates 1/2-13 Pistons ⊗ Air Inlet 1/4 N.P.T. No Alignment Specified-Center Stud Mounting is Standard
- ⊗ Combination Stud/Air Inlet Stud Outside Thread is 3/4-16 Studs Inside Thread (Air Inlet) is 1/4 N.P.T. Exceptions Will Be Noted on Part View as ⊗

1T - Reversible Sleeve

BELLOW NO. ASSEMBLY ORDER NO.	CROSS SECTION VIEW	BEAD PLATE TOP VIEW	PISTON BOTTOM VIEW	ASSEMBLY WEIGHT (lbs.)	REPLACES
1T15MT-3 W01-358-9634				15.9	Freightliner 16-14263-000 Freightliner 16-15443-000 (6033 bracket) Freightliner 16-14263-001 Freightliner 16-15443-001 (6034 bracket) Freightliner 16-15444-000 service (no bracket, no piston) --reuse old bracket or purchase separately (pg.62) REPLACEMENT
1T15MT-3 W01-358-9640				14.2	Hendrickson Trailer S20223 (HT-190T, HS-190T) - replaces W01-358-9630
1T15MT-3 W01-358-9774				16.0	Freightliner Custom Chassis 16-15762-000 Ambulance
1T15M-4 W01-358-8802				12.0	Ridewell 1003588802C Holland (Neway) 90557170
1T15M-4 W01-358-8803				13.1	Ridewell 1003588803C Holland (Neway) 90557194 (Dock-Mate)

1T Style Springs

Hardware Key

- Bolt or Stud 1/2-13 ⊙ Threaded Hole 3/8-16 Blind Nut on Bead Plates 1/2-13 Pistons ⊗ Air Inlet 1/4 N.P.T. No Alignment Specified-Center Stud Mounting is Standard
- ⊗ Combination Stud/Air Inlet Stud Outside Thread is 3/4-16 Studs Inside Thread (Air Inlet) is 1/4 N.P.T. Exceptions Will Be Noted on Part View as ⊗

Firestone

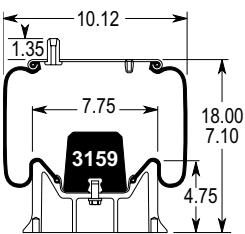
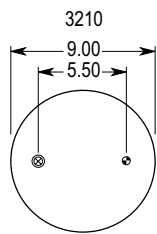
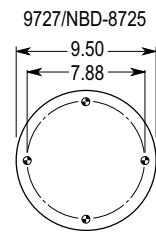
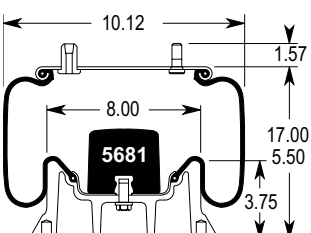
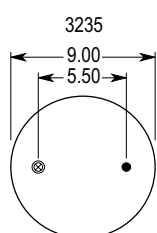
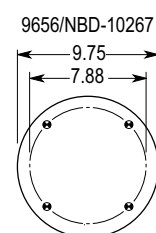
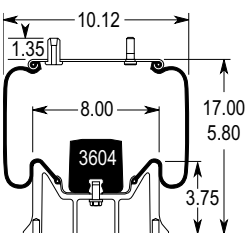
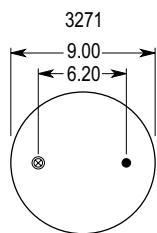
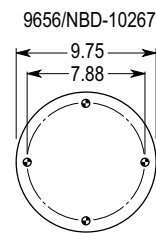
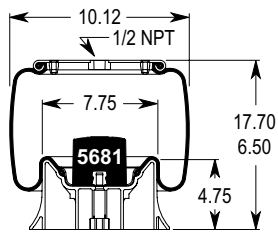
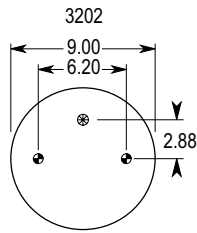
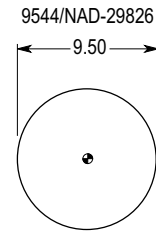
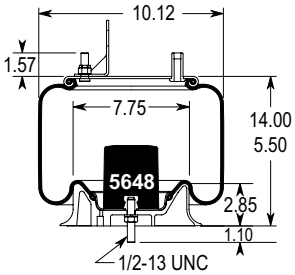
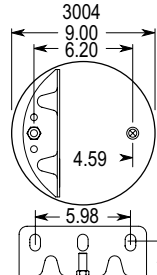
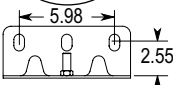
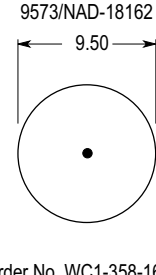
BELLOW NO. ASSEMBLY ORDER NO.	CROSS SECTION VIEW	BEAD PLATE TOP VIEW	PISTON BOTTOM VIEW	ASSEMBLY WEIGHT (lbs.)	REPLACES
1T15M-4 W01-358-8805			 <p>Order No. WC1-358-0651</p>	16.2	Ridewell 1003588805C
1T15M-4 W01-358-8806			 <p>Order No. WC1-358-0652</p>	14.0	Ridewell 1003588806C
1T15M-4 W01-358-8810			 <p>Order No. WC1-358-0652</p>	15.0	Hagie
1T15M-4 W01-358-8813			 <p>Order No. WC1-358-0666</p>	12.6	Kenworth C81-1003 Airglide 380 Peterbilt C81-6000 Flex Air
1T15M-4 W01-358-8816 BRACKET WC1-358-3904		 	 <p>Order No. WC1-358-1634</p>	13.1	Hendrickson 60929-2

Hardware Key

- Bolt or Stud 1/2-13 ● Threaded Hole 3/8-16 Blind Nut on Bead Plates 1/2-13 Pistons ⊗ Air Inlet 1/4 N.P.T. No Alignment Specified-Center Stud Mounting is Standard
- ⊗ Combination Stud/Air Inlet Stud Outside Thread is 3/4-16 Studs Inside Thread (Air Inlet) is 1/4 N.P.T. Exceptions Will Be Noted on Part View as ⊗

1T - Reversible Sleeve

BELLOW NO. ASSEMBLY ORDER NO.	CROSS SECTION VIEW	BEAD PLATE TOP VIEW	PISTON BOTTOM VIEW	ASSEMBLY WEIGHT (lbs.)	REPLACES
1T15M-4 W01-358-8817 BRACKET WC1-358-3904			9573/NAD-18162 Order No. WC1-358-1634	13.2	Hendrickson 60925-2
1T15M-4 W01-358-9008			9727/NBD-8725 Order No. WC1-358-0651	14.1	Ridewell 1003589008C
1T15M-4 W01-358-9010			9727/NBD-8725 Order No. WC1-358-0651	16.2	Ridewell 1003589010C (replaces 9064) Reyco 12928-01 Hendrickson Trailer S2827 Hendrickson Trailer S11566 (remove bolt) Watson & Chalin AS-0044
1T15M-4 W01-358-9011			9727/NBD-8725 Order No. WC1-358-0651	16.1	Hendrickson Trailer S2307
1T15M-4 W01-358-9059			9727/NBD-8725 Order No. WC1-358-0651	16.3	Hutchens H-1913-1

1T Style Springs

Hardware Key

- Bolt or Stud 1/2-13 ⊗ Threaded Hole 3/8-16 Blind Nut on Bead Plates 1/2-13 Pistons ⊗ Air Inlet 1/4 N.P.T. No Alignment Specified-Center Stud Mounting is Standard
- ⊗ Combination Stud/Air Inlet Stud Outside Thread is 3/4-16 Studs Inside Thread (Air Inlet) is 1/4 N.P.T. Exceptions Will Be Noted on Part View as ⊗

Firestone

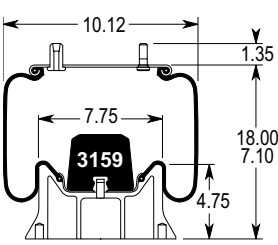
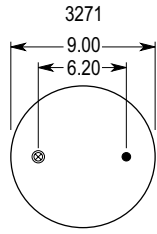
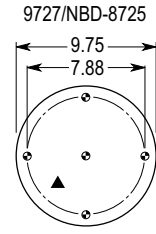
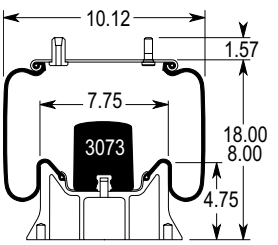
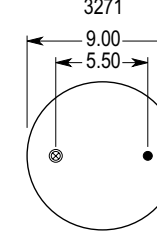
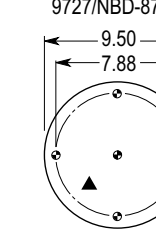
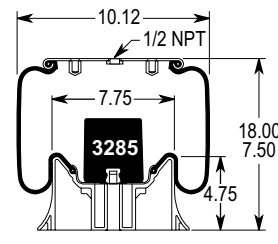
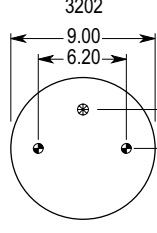
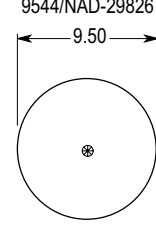
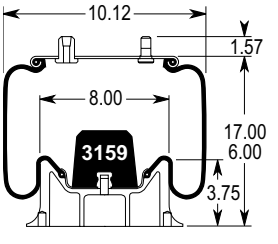
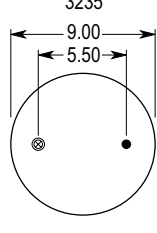
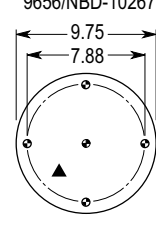
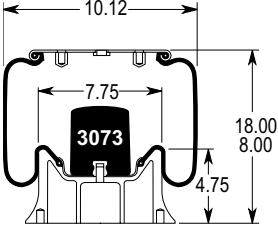
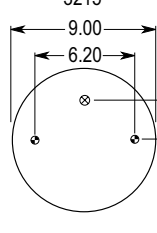
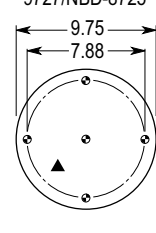
BELLOW NO. ASSEMBLY ORDER NO.	CROSS SECTION VIEW	BEAD PLATE TOP VIEW	PISTON BOTTOM VIEW	ASSEMBLY WEIGHT (lbs.)	REPLACES
1T15M-4 W01-358-9063			 Order No. WC1-358-0651	16.2	Navistar 359519C-1
1T15M-4 W01-358-9068			 Order No. WC1-358-0651	16.6	Navistar
1T15M-4 W01-358-9069			 Order No. WC1-358-0666	14.2	Peterbilt 03-02456 Peterbilt 03-04759 Peterbilt 03-01649 Peterbilt 03-06746 Peterbilt 03-07112 Peterbilt 03-02038 (Air-Trac) MFG.SV# Peterbilt 03-10042
1T15M-4 W01-358-9070			 Order No. WC1-358-0652	15.2	Holland (Neway) 90557038 Holland (Neway) 90557090 (AR-90-1-12) Silent Drive
1T15M-4 W01-358-9071			 Order No. WC1-358-0651	16.1	Fab Tek (West.Unit) 101357 Ridewell 1003589071C Pioneer Trailer

Hardware Key

- Bolt or Stud 1/2-13
- ⊙ Threaded Hole 3/8-16 Blind Nut on Bead Plates 1/2-13 Pistons
- ⊗ Air Inlet 1/4 N.P.T.
- ⊕ No Alignment Specified-Center Stud Mounting is Standard
- ⊗ Combination Stud/Air Inlet Stud Outside Thread is 3/4-16
- ⊕ Studs Inside Thread (Air Inlet) is 1/4 N.P.T. Exceptions Will Be Noted on Part View as ⊗

1T - Reversible Sleeve

BELLOW NO. ASSEMBLY ORDER NO.	CROSS SECTION VIEW	BEAD PLATE TOP VIEW	PISTON BOTTOM VIEW	ASSEMBLY WEIGHT (lbs.)	REPLACES
1T15M-4 W01-358-9335 BRACKET 70-3582-6042			9573/NBD-18162 Order No. WC1-358-1634	12.3	Hendrickson 56917-1 & 2 (Class 6 & 7 Freight-liner) - ref.56916 (W01-358-9284) -superseded
1T15M-4 W01-358-9336			9549/NAD-29454 Order No. WC1-358-1616	13.4	Watson & Chalin AS-0053
1T15M-4 W01-358-9463			9656/NBD-10267 Order No. WC1-358-0652	15.2	Holland (Neway) 90557130-RH Holland (Neway) 90557131-LH
1T15M-4 W01-358-9467			9728/NAD-8987 Order No. WC1-358-0669	18.6	Ridewell 1003589467C
1T15M-4 W01-358-9482 BRACKET WC1-358-3887			9549/NAD-29454 Order No. WC1-358-1616	15.0	Holland (Neway) 90557161 (AD200-7) (Gillig) - ref. W01-358-9585 (1/2ONPT)

1T Style Springs

Hardware Key

- Bolt or Stud 1/2-13 ● Threaded Hole 3/8-16 Blind Nut on Bead Plates 1/2-13 Pistons ⊗ Air Inlet 1/4 N.P.T. No Alignment Specified-Center Stud Mounting is Standard
- ⊗ Combination Stud/Air Inlet Stud Outside Thread is 3/4-16 Studs Inside Thread (Air Inlet) is 1/4 N.P.T. Exceptions Will Be Noted on Part View as ⊗

Firestone

BELLOW NO. ASSEMBLY ORDER NO.	CROSS SECTION VIEW	BEAD PLATE TOP VIEW	PISTON BOTTOM VIEW	ASSEMBLY WEIGHT (lbs.)	REPLACES
1T15M-4 W01-358-9483 BRACKET WC1-358-3887			9544/NAD-29826 Order No. WC1-358-0666	15.2	Holland (Neway) 90557166 (AD200-8) (Gillig)
1T15M-4 W01-358-9484			9544/NAD-29826 Order No. WC1-358-0666	12.9	Holland (Neway) 90557158
1T15M-4 W01-358-9507 BRACKET WC1-358-3887			9727/NBD-8724 Order No. WC1-358-0651	16.2	Holland (Neway) 90557313
1T15M-4 W01-358-9585 BRACKET WC1-358-3887			9549/NAD-29454 Order No. WC1-358-1616	15.4	Holland (Neway) 90557247 (replaces 90557219-flush fitting) - ref. W01- 358-9482
1T15M-4 W01-358-9697			9532/NAD-29827 Order No. WC1-358-1619	13.9	Holland 90557329

Hardware Key

- Bolt or Stud 1/2-13 ⊕ Threaded Hole 3/8-16 Blind Nut on Bead Plates 1/2-13 Pistons ⊗ Air Inlet 1/4 N.P.T. No Alignment Specified-Center Stud Mounting is Standard
- ⊗ Combination Stud/Air Inlet Stud Outside Thread is 3/4-16 Studs Inside Thread (Air Inlet) is 1/4 N.P.T. Exceptions Will Be Noted on Part View as ⊗

1T - Reversible Sleeve

BELLOW NO. ASSEMBLY ORDER NO.	CROSS SECTION VIEW	BEAD PLATE TOP VIEW	PISTON BOTTOM VIEW	ASSEMBLY WEIGHT (lbs.)	REPLACES
1T15M-4 W01-358-9797			<p>Order No. WC1-358-0652</p>	13.9	Ridewell 1003589797C
1T15M-4 W01-358-9798			<p>Order No. WC1-358-0652</p>	15.3	Holland (Neway) 90557105 (GM-U-Haul) Holland (Neway) 90557137 (only 2 studs in piston and 90i alignment) REPLACEMENT PISTON COMES WITHOUT STUDS
1T15M-6 W01-358-8824			<p>Order No. WC1-358-9452</p>	13.9	Tuthill-Reyco 702614-01
1T15M-6 W01-358-8829 BRACKET WC1-358-6027			<p>Order No. WC1-358-1628</p>	14.7	Volvo 3934699 Volvo 8079902
1T15M-6 W01-358-8924			<p>Order No. WC1-358-9452</p>	15.0	Ridewell 1003588924C

1T Style Springs

Hardware Key

- Bolt or Stud 1/2-13 ⊗ Threaded Hole 3/8-16 Blind Nut on Bead Plates 1/2-13 Pistons ⊗ Air Inlet 1/4 N.P.T. No Alignment Specified-Center Stud Mounting is Standard
- ⊗ Combination Stud/Air Inlet Stud Outside Thread is 3/4-16 Studs Inside Thread (Air Inlet) is 1/4 N.P.T. Exceptions Will Be Noted on Part View as ⊗

Firestone

BELLOW NO. ASSEMBLY ORDER NO.	CROSS SECTION VIEW	BEAD PLATE TOP VIEW	PISTON BOTTOM VIEW	ASSEMBLY WEIGHT (lbs.)	REPLACES
1T15M-6 W01-358-8927			9544/NAD-29826 Order No. WC1-358-0666	14.5	Watson & Chalin AS-0062
1T15M-6 W01-358-9004			9727/NBD-8725 Order No. WC1-358-0651	15.3	Watson & Chalin AS-0043
1T15M-6 W01-358-9026			9532/NAD-29827 Order No. WC1-358-1619	12.7	Peterbilt 03-06213 Peterbilt 03-07111 (Low Air Leaf)
1T15M-6 W01-358-9082 SERVICE ASSEMBLY W01-358-0712			9530/NAD-27809 Order No. WC1-358-9452	15.0	Hendrickson Can. S2066, S11651, B-12514-007 Kelderman Hutchens H-9630-01 Kwik Lok/ToDo (Jif- flox) CP-5125 Holland (Neway) 90557006, 90557027, 90557033 (special mount- ing), 90557037, 90557054, 90557075 Reyco 12882-01 R & S Truck & body
1T15M-6 W01-358-9083 SERVICE ASSEMBLY W01-358-9080			9530/NAD-27809 Order No. WC1-358-9452	13.2	Granning 1359 Watson & Chalin AS-0028 Ridewell 1003589083C Hendrickson Trailer S1561

Hardware Key

- Bolt or Stud 1/2-13
- ⊙ Threaded Hole 3/8-16 Blind Nut on Bead Plates 1/2-13 Pistons
- ⊗ Air Inlet 1/4 N.P.T.
- ⊕ No Alignment Specified-Center Stud Mounting is Standard
- ⊗ Combination Stud/Air Inlet Stud Outside Thread is 3/4-16
- ⊕ Studs Inside Thread (Air Inlet) is 1/4 N.P.T. Exceptions Will Be Noted on Part View as ⊗

1T - Reversible Sleeve

BELLOW NO. ASSEMBLY ORDER NO.	CROSS SECTION VIEW	BEAD PLATE TOP VIEW	PISTON BOTTOM VIEW	ASSEMBLY WEIGHT (lbs.)	REPLACES
1T15M-6 W01-358-9092			<p>Order No. WC1-358-9452</p>	15.1	Holland (Neway) 90557031 Hendrickson Can. S12353
1T15M-6 W01-358-9093 SERVICE ASSEMBLY W01-358-0712			<p>Order No. WC1-358-9453</p>	16.0	Holland (Neway) 90557007 Holland (Neway) 90557032 Holland (Neway) 90557035
1T15M-6 W01-358-9096 SERVICE ASSEMBLY W01-358-0707			<p>Order No. WC1-358-9452</p>	14.8	Fruehauf UCE-1304-1
1T15M-6 W01-358-9193			<p>Order No. WC1-358-9452</p>	15.1	Holland (Neway) 90557101 REPLACEMENT PISTON COMES WITHOUT STUDS
1T15M-6 W01-358-9194			<p>Order No. WC1-358-1619</p>	13.0	Peterbilt 03-05107

1T Style Springs

Hardware Key

- Bolt or Stud 1/2-13 ⊗ Threaded Hole 3/8-16 Blind Nut on Bead Plates 1/2-13 Pistons ⊗ Air Inlet 1/4 N.P.T. No Alignment Specified-Center Stud Mounting is Standard
- ⊗ Combination Stud/Air Inlet Stud Outside Thread is 3/4-16 Studs Inside Thread (Air Inlet) is 1/4 N.P.T. Exceptions Will Be Noted on Part View as ⊗

Firestone

BELLOW NO. ASSEMBLY ORDER NO.	CROSS SECTION VIEW	BEAD PLATE TOP VIEW	PISTON BOTTOM VIEW	ASSEMBLY WEIGHT (lbs.)	REPLACES
1T15M-6 W01-358-9210 SERVICE ASSEMBLY W01-358-9080			9951/NAD-17833 	15.9	Granning 2577
1T15M-6 W01-358-9211 SERVICE ASSEMBLY W01-358-0712			9951/NAD-17833 	17.3	Granning 2692
1T15M-6 W01-358-9213 SERVICE ASSEMBLY W01-358-0748			9560/NAD-32768 	13.3	Navistar 501559C-1 Navistar 501559C-2 Navistar 1660581C-1
1T15M-6 W01-358-9219			9560/NAD-32768 	13.5	Volvo/GM Heavy Duty Truck 35003-3201 Volvo/GM Heavy Duty Truck 35203-3203 Volvo/GM Heavy Duty Truck 35003-3204 Volvo/GM Heavy Duty Truck 35003-3209
1T15M-6 W01-358-9223 WAS 1T15LX8			9809/NBD-9611 	20.6	Reyco 12884-01 Reyco 12884-01A (102AR) Henrickson 48195-2

Hardware Key

- Bolt or Stud 1/2-13
- ⊙ Threaded Hole 3/8-16 Blind Nut on Bead Plates 1/2-13 Pistons
- ⊗ Air Inlet 1/4 N.P.T.
- ⊕ No Alignment Specified-Center Stud Mounting is Standard
- ⊗ Combination Stud/Air Inlet Stud Outside Thread is 3/4-16
- ⊙ Studs Inside Thread (Air Inlet) is 1/4 N.P.T. Exceptions Will Be Noted on Part View as ⊗

1T - Reversible Sleeve

BELLOW NO. ASSEMBLY ORDER NO.	CROSS SECTION VIEW	BEAD PLATE TOP VIEW	PISTON BOTTOM VIEW	ASSEMBLY WEIGHT (lbs.)	REPLACES
1T15M-6			<p>Order No. WC1-358-9452</p>	15.0	Hendrickson Trailer S2924 Hendrickson 48195-1 (b.plate studs-1.350) (2 studs in piston at 90i alignment)
W01-358-9227					
1T15M-6			<p>Order No. WC1-358-0669</p>	18.7	Hendrickson B-3411
W01-358-9228					
1T15M-6			<p>Order No. WC1-358-9452</p>	15.4	Hendrickson 49160-0E REPLACEMENT PISTON COMES WITHOUT STUDS
W01-358-9256					
1T16M-6			<p>Order No. WC1-358-1620</p>	14.4	Volvo/GM 8061151 Volvo/GM 8169868
W01-358-9296					
1T15M-6			<p>Order No. WC1-358-0664</p>	16.2	Holland (Neway) 90557124 (AR-90115 & 16) Watson Chalin AS-0059
W01-358-9304					

1T Style Springs

Hardware Key

- Bolt or Stud 1/2-13 ⊗ Threaded Hole 3/8-16 Blind Nut on Bead Plates 1/2-13 Pistons ⊗ Air Inlet 1/4 N.P.T. No Alignment Specified-Center Stud Mounting is Standard
- ⊗ Combination Stud/Air Inlet Stud Outside Thread is 3/4-16 Studs Inside Thread (Air Inlet) is 1/4 N.P.T. Exceptions Will Be Noted on Part View as ⊗

Firestone

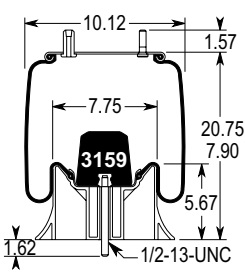
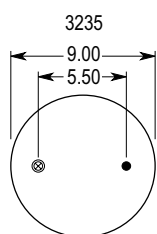
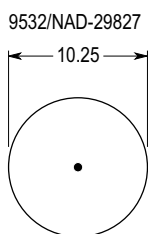
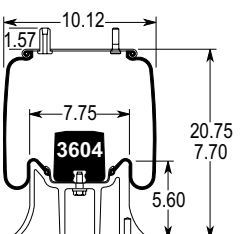
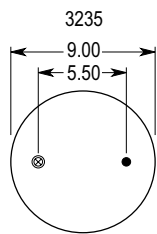
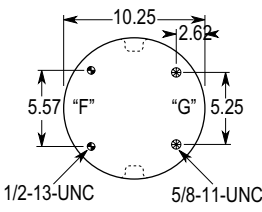
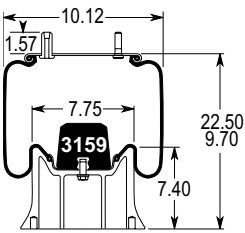
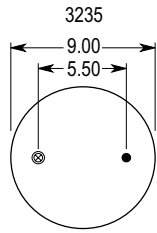
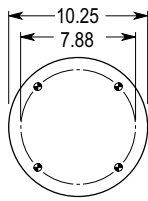
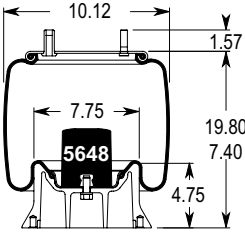
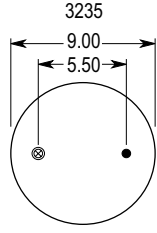
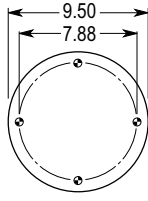
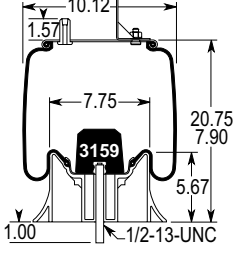
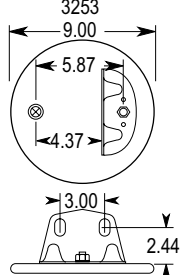
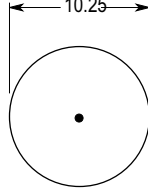
BELLOW NO. ASSEMBLY ORDER NO.	CROSS SECTION VIEW	BEAD PLATE TOP VIEW	PISTON BOTTOM VIEW	ASSEMBLY WEIGHT (lbs.)	REPLACES
1T15M-6 W01-358-9362			9532/NAD-29827  Order No. WC1-358-1619	14.9	Watson & Chalin AS-0049 Holland (Neway) 90557113 (AR90-1-14&17) (AR75-6&9)
1T15M-6 W01-358-9388			9951/NAD-17833  Order No. WC1-358-0697	17.3	Granning 3750
1T15M-6 W01-358-9392 SERVICE ASSEMBLY W01-358-0712			9553/NAD-29467  Order No. WC1-358-9453	16.0	Hendrickson Trailer S4773
1T15M-6 W01-358-9474			9727/NBD-8724  Order No. WC1-358-0651	15.1	Reyco 20966-01 Everly
1T15M-6 W01-358-9496 BRACKET WC1-358-3887			9532/NAD-29827  Order No. WC1-358-1619	15.9	Holland (Neway) 90557208

Hardware Key

- Bolt or Stud 1/2-13
- ⊙ Threaded Hole 3/8-16 Blind Nut on Bead Plates 1/2-13 Pistons
- ⊗ Air Inlet 1/4 N.P.T.
- ⊕ No Alignment Specified-Center Stud Mounting is Standard
- ⊗ Combination Stud/Air Inlet Stud Outside Thread is 3/4-16
- ⊕ Studs Inside Thread (Air Inlet) is 1/4 N.P.T. Exceptions Will Be Noted on Part View as ⊗

1T - Reversible Sleeve

BELLOW NO. ASSEMBLY ORDER NO.	CROSS SECTION VIEW	BEAD PLATE TOP VIEW	PISTON BOTTOM VIEW	ASSEMBLY WEIGHT (lbs.)	REPLACES
1T15M-6 W01-358-9690 BRACKET 70-3582-6030			9809/NBD-9611 Order No. WC1-358-0660	22.5	Reyco 24894-02
1T15M-6 W01-358-9944			9809/NBD-9611 Order No. WC1-358-0660	21.4	Reyco 12884-01B
1T15M-6 W01-358-9966 BRACKET 70-3582-6030			9809/NBD-9611 Order No. WC1-358-0660	22.4	Reyco 20124-02 (1/2 NPT) Reyco 20124-01 Reyco 20124-01K (1/4 NPT) - [Use 1/2 to 1/4 NPT adaptor]
1T15MB-TW-6 W01-358-9644			9532/NAD-29827 Order No. WC1-358-1619	13.6	Hendrickson Trailer S23721
1T15MJ-6 W01-358-9097			9744/NBD-9673 Order No. N/A		Navistar 426213C-1 Navistar 4545910C-1 Navistar 442307C-91 Navistar 4545889C-1

1T Style Springs

OBSOLETE
NO LONGER AVAILABLE

Hardware Key

- Bolt or Stud 1/2-13 ⊗ Threaded Hole 3/8-16 Blind Nut on Bead Plates 1/2-13 Pistons ⊗ Air Inlet 1/4 N.P.T. No Alignment Specified-Center Stud Mounting is Standard
- ⊗ Combination Stud/Air Inlet Stud Outside Thread is 3/4-16 Studs Inside Thread (Air Inlet) is 1/4 N.P.T. Exceptions Will Be Noted on Part View as ⊗

Firestone

BELLOW NO. ASSEMBLY ORDER NO.	CROSS SECTION VIEW	BEAD PLATE TOP VIEW	PISTON BOTTOM VIEW	ASSEMBLY WEIGHT (lbs.)	REPLACES
1T15MJ-6 W01-358-9098			9744/NBD-9673 		Navistar 350243C-94 Navistar 442305C-91 Navistar 426212C-1 Navistar 442306C-91 Navistar 454590C-1 Navistar 454588C-91
1T15M-6 W01-358-9466			9561/NAD-32767 	14.3	Hendrickson 49048 (Ford) Hendrickson 49674-1&2 (Mack) (57QL411M) Hendrickson 49207 (Marmon) HA-360/400/460 [up to 1991]
1T15MT-6 W01-358-9643 BRACKET WC1-358-3903			9538/NAD-27740 	16.0	Hendrickson 58995-2 (Freightliner)
1T15MW-6 W01-358-9299 (WAS 1T15MM-5)			9694/NAD-25396 	16.0	Hendrickson Trailer S20716 [HT250U(6.5-002)]
1T15M-LW-7 W01-358-8944			9694/NAD-25396 	16.7	Hendrickson Trailer S20217 (HT-190U) - supersedes W01-358-9015

OBSOLETE
NO LONGER AVAILABLE

Hardware Key

- Bolt or Stud 1/2-13 ● Threaded Hole 3/8-16 Blind Nut on Bead Plates 1/2-13 Pistons ⊗ Air Inlet 1/4 N.P.T. No Alignment Specified-Center Stud Mounting is Standard
- ⊗ Combination Stud/Air Inlet Stud Outside Thread is 3/4-16 Studs Inside Thread (Air Inlet) is 1/4 N.P.T. Exceptions Will Be Noted on Part View as ⊗

1T - Reversible Sleeve

BELLOW NO. ASSEMBLY ORDER NO.	CROSS SECTION VIEW	BEAD PLATE TOP VIEW	PISTON BOTTOM VIEW	ASSEMBLY WEIGHT (lbs.)	REPLACES
1T15MPW-7 W01- M58-6260 METRIC			9538/NAD-27740 Order No. WC1-358-1628	15.4	Hendrickson 59053-2
1T15MPW-7 W01-358- 8903			9519/NAD-19774 Order No. WC1-358-1619	13.6	Holland (Neway) 90557169 (Advance Mixer)
1T15MPW-7 W01- M58-6317 METRIC			9544/NAD-29826 M12 X 1.75 Order No. WC1-358-0666	13.6	Holland (Neway) 90557233
1T15MPW-7 W01-358- 6262			9557/NAD-31181 Order No. WC1-358-1654	14.3	Arvin Meritor 21227742 FS25
1T15M-7.5 W01-358- 8888			9530/NAD-27809 Order No. WC1-358-9452	14.0	Rowe Truck ASC2500/AS- C2500ROS Ride Rowe Trailer ASCT2500

1T Style Springs

Hardware Key

- Bolt or Stud 1/2-13 ● Threaded Hole 3/8-16 Blind Nut on Bead Plates 1/2-13 Pistons ⊗ Air Inlet 1/4 N.P.T. No Alignment Specified-Center Stud Mounting is Standard
- ⊗ Combination Stud/Air Inlet Stud Outside Thread is 3/4-16 Studs Inside Thread (Air Inlet) is 1/4 N.P.T. Exceptions Will Be Noted on Part View as ⊗

Firestone

BELLOW NO. ASSEMBLY ORDER NO.	CROSS SECTION VIEW	BEAD PLATE TOP VIEW	PISTON BOTTOM VIEW	ASSEMBLY WEIGHT (lbs.)	REPLACES
1T15M-7.5 W01-358-9342				13.7	Granning 2727 (supersedes 9298) Chalmers (remove bolt) - Suspension should have axle stops-if not-use W01-358-9245
1T15M-7.5 W01-358-9902				14.0	Holland (Neway) 90557138
1T15M-7.5 W01-358-9921				13.6	Holland (Neway) 90557117 (AR92-12&14), (AR93-14) Watson & Chalin AS-0090 Silent Drive
1T15M-7.5 W01-358-9922				15.0	Holland (Neway) 90557119 (AR92-17) (AR93-17)
1T15M-7.5 W01-358-9923				13.7	Holland (Neway) 90557118 (AR92&93-15&16)

Hardware Key

- Bolt or Stud 1/2-13
- ⊙ Threaded Hole 3/8-16 Blind Nut on Bead Plates 1/2-13 Pistons
- ⊗ Air Inlet 1/4 N.P.T.
- ⊕ No Alignment Specified-Center Stud Mounting is Standard
- ⊗ Combination Stud/Air Inlet Stud Outside Thread is 3/4-16
- ⊕ Studs Inside Thread (Air Inlet) is 1/4 N.P.T. Exceptions Will Be Noted on Part View as ⊗

1T - Reversible Sleeve

BELLOW NO. ASSEMBLY ORDER NO.	CROSS SECTION VIEW	BEAD PLATE TOP VIEW	PISTON BOTTOM VIEW	ASSEMBLY WEIGHT (lbs.)	REPLACES
1T15M-7.5 W01-358-9935			 Order No. WC1-358-1619	13.8	Holland (Neway) 90557157 (RL-228-17) Holland (Neway) 90557301
1T15M-7.5 W01-358-9936			 Order No. WC1-358-0666	13.9	Holland (Neway) 90557156 (RL-228-14,15,16) Holland (Neway) 90557300
1T15M-7.5 W01-358-9942			 Order No. WC1-358-1619	14.1	Holland (Neway) 90557142
1T15M-7.5 W01-358-9943			 Order No. WC1-358-0664	15.2	Holland (Neway) 90557143
1T15M-7.5 W01-358-9947 BRACKET 70-3582-6030			 Order No. WC1-358-0666	15.9	Reyco 20142-01 & 01K

1T Style Springs

Hardware Key

- Bolt or Stud 1/2-13 ⊗ Threaded Hole 3/8-16 Blind Nut on Bead Plates 1/2-13 Pistons ⊗ Air Inlet 1/4 N.P.T. No Alignment Specified-Center Stud Mounting is Standard
- ⊗ Combination Stud/Air Inlet Stud Outside Thread is 3/4-16 Studs Inside Thread (Air Inlet) is 1/4 N.P.T. Exceptions Will Be Noted on Part View as ⊗

Firestone

BELLOW NO. ASSEMBLY ORDER NO.	CROSS SECTION VIEW	BEAD PLATE TOP VIEW	PISTON BOTTOM VIEW	ASSEMBLY WEIGHT (lbs.)	REPLACES
1T15M-7.5 W01-358-9948			<p>Order No. WC1-358-1636</p>	17.7	Holland (Neway) 90557227 V-Steer 1 (Ride Bag)
1T15M-7.5 W01-358-9971			<p>Order No. WC1-358-0659</p>	15.5	Holland (Neway) 90557295 (RL230,GRL228)
1T15M-7.5 W01-358-9972			<p>Order No. WC1-358-1619</p>	14.0	Holland (Neway) 90557302 RL230
1T15M-7.5 W01-358-9974			<p>Order No. N/A</p>	14.3	Holland 90557332
1T15M-8 W01-358-9287 BRACKET 70-3582-6042 NEW BRACKET 70-3583-6044			<p>Order No. WC1-358-1606</p>	18.5	Hendrickson 50405-1&2 (Ford, W.Star) HA-360/400/460 [1991-Up] Hendrickson 50405 (remove intermediate plate and use new production version with bracket)

Hardware Key

- Bolt or Stud 1/2-13
- ⊗ Threaded Hole 3/8-16 Blind Nut on Bead Plates 1/2-13 Pistons
- ⊗ Air Inlet 1/4 N.P.T.
- ⊗ No Alignment Specified-Center Stud Mounting is Standard
- ⊗ Combination Stud/Air Inlet Stud Outside Thread is 3/4-16
- ⊗ Studs Inside Thread (Air Inlet) is 1/4 N.P.T. Exceptions Will Be Noted on Part View as ⊗

1T - Reversible Sleeve

BELLOW NO. ASSEMBLY ORDER NO.	CROSS SECTION VIEW	BEAD PLATE TOP VIEW	PISTON BOTTOM VIEW	ASSEMBLY WEIGHT (lbs.)	REPLACES
1T15M-8 W01-358-9297 BRACKET 70-3582-6042 NEW BRACKET 70-3583-6044			9538/NAD-27740 Order No. WC1-358-1628	16.5	Hendrickson 50898-1 & 2 (GH & Ford) (class 6, 7 & 8) Hendrickson Truck 64651-2
1T15M-8 W01-358-9371 BRACKET 70-3582-6047			9560/NAD-32768 Order No. WC1-358-1620	18.0	Navistar 1670073C-1 Navistar 1686386C-1 Navistar 2027911C-1
1T15M-8 W01-358-9372 METRIC BRACKET 70-3582-6050			9538/NAD-27740 Order No. WC1-358-1628	18.0	Hendrickson 58520-2 (Nissan) (replaces 58654-2) Hendrickson Truck 64489-2
1T15M-8 W01-358-9373 BRACKET 70-3582-6042 NEW BRACKET 70-3582-6044			9538/NAD-27740 Order No. WC1-358-1628	16.2	Hendrickson 57122-2 (Ford, class 8) HAS-360/400/402/460
1T15M-8 W01-358-9375 BRACKET 70-3582-6041			9538/NAD-27740 Order No. WC1-358-1628	16.9	Hendrickson 50899-1 & 2 (Mack-class 8) 57QL414M Mack 3645Q27 57QL414M

1T Style Springs

Hardware Key

- Bolt or Stud 1/2-13 ⊗ Threaded Hole 3/8-16 Blind Nut on Bead Plates 1/2-13 Pistons ⊗ Air Inlet 1/4 N.P.T. No Alignment Specified-Center Stud Mounting is Standard
- ⊗ Combination Stud/Air Inlet Stud Outside Thread is 3/4-16 Studs Inside Thread (Air Inlet) is 1/4 N.P.T. Exceptions Will Be Noted on Part View as ⊗

Firestone

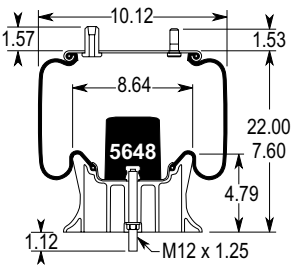
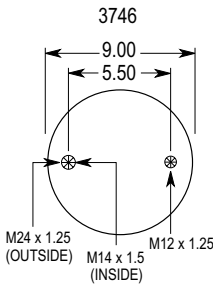
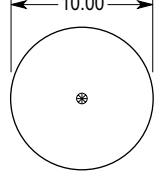
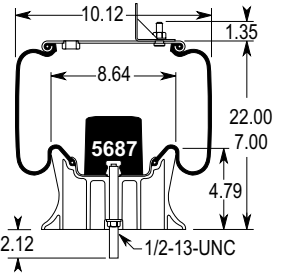
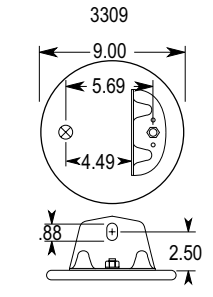
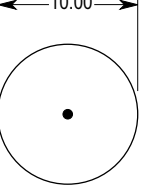
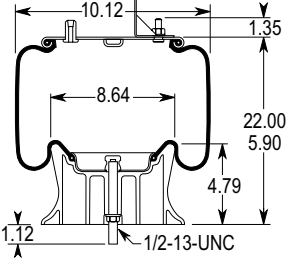
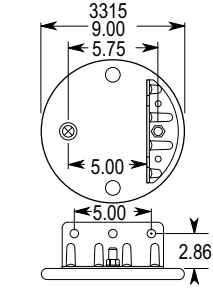
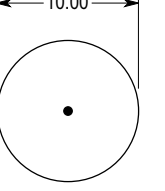
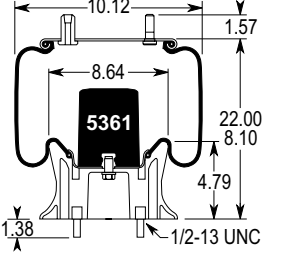
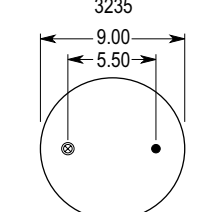
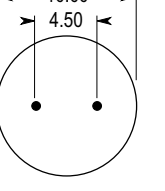
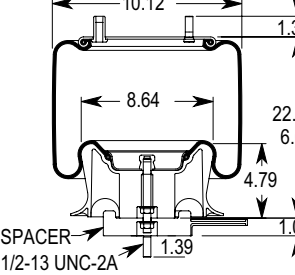
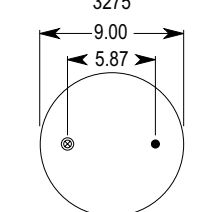
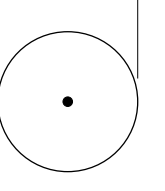
BELLOW NO. ASSEMBLY ORDER NO.	CROSS SECTION VIEW	BEAD PLATE TOP VIEW	PISTON BOTTOM VIEW	ASSEMBLY WEIGHT (lbs.)	REPLACES
1T15M-8 W01- M58-9642			9538/NAD-27740  Order No. WC1-358-1628	14.6	Hendrickson 59055-2 - (HAD 150 & 190) replaces 58817-2 RVI/US
1T15M-8 W01-358- 9647 BRACKET 70-3582-6051			9538/NAD-27740  Order No. WC1-358-1628	15.9	Hendrickson 58786-2 (MACK 57QL417M)
1T15M-8 W01-358- 9648 BRACKET 70-3582-6047			9538/NAD-27740  Order No. WC1-358-1628	15.8	Navistar 2027911C1 & C2
1T15M-8 W01-358- 9649			9561/NAD-32767  Order No. WC1-358-1606	17.2	Holland (Neway) 90557252
1T15M-8 W01-358- 9654			9538/NAD-27740  Order No. WC1-358-1628	15.1	Hendrickson 65032-2

Hardware Key

- Bolt or Stud 1/2-13 ● Threaded Hole 3/8-16 Blind Nut on Bead Plates 1/2-13 Pistons ⊗ Air Inlet 1/4 N.P.T. No Alignment Specified-Center Stud Mounting is Standard
- ⊗ Combination Stud/Air Inlet Stud Outside Thread is 3/4-16 Studs Inside Thread (Air Inlet) is 1/4 N.P.T. Exceptions Will Be Noted on Part View as ⊗

1T - Reversible Sleeve

BELLOW NO. ASSEMBLY ORDER NO.	CROSS SECTION VIEW	BEAD PLATE TOP VIEW	PISTON BOTTOM VIEW	ASSEMBLY WEIGHT (lbs.)	REPLACES
1T15M-8 W01- M58-9656				16.1	Hendrickson Truck 64651-2
1T15M-8 W01-358- 9663				16.2	Hendrickson Truck 60271-2
1T15M-9 W01-358- 8842				15.2	Link 1103-0058
1T15M-9 W01-358- 8852				13.2	Peterbilt 03-07887 (Low Air Leaf)
1T15M-9 W01-358- 8855				14.6	Reyco 23521-01

1T Style Springs

Hardware Key

- Bolt or Stud 1/2-13 ⊗ Threaded Hole 3/8-16 Blind Nut on Bead Plates 1/2-13 Pistons ⊗ Air Inlet 1/4 N.P.T. No Alignment Specified-Center Stud Mounting is Standard
- ⊗ Combination Stud/Air Inlet Stud Outside Thread is 3/4-16 Studs Inside Thread (Air Inlet) is 1/4 N.P.T. Exceptions Will Be Noted on Part View as ⊗

Firestone

BELLOW NO. ASSEMBLY ORDER NO.	CROSS SECTION VIEW	BEAD PLATE TOP VIEW	PISTON BOTTOM VIEW	ASSEMBLY WEIGHT (lbs.)	REPLACES
1T15M-9 W01-358-8856				14.5	Reyco 23521-02 Order No. WC1-358-9452
1T15M-9 W01-358-8864				14.1	Peterbilt 03-08716 (New Low Leaf Su- persedes 03-07887 effective 04/04) C811011 Paccar Part Order No. WC1-358-1626
1T15M-9 W01-358-9101 SERVICE ASSEMBLY W01-358-9102				16.7	Holland (Neway) 90557008 Holland (Neway) 90557009 Holland (Neway) 90557082 Ridewell 1003589101C Reyco 12883-01 Silent Drive Truckstell (Marion Mfg.) 63647 MFG.SV.# Neway 90044201 Watson & Chalin AS-0040 Order No. WC1-358-9453
1T15M-9 W01-358-9192 SERVICE ASSEMBLY W01-358-9102				15.9	Hendrickson Trailer S6195 Holland (Neway) 90557086 Holland (Neway) 90557108 (AR-90) Watson & Chalin AS- 0038 AS-0046 Rotate Piston 90557135-28iLH Rotate Piston 90557136-28iRH Order No. WC1-358-9452
1T15M-9 W01-358-9203				16.0	Hendrickson Trailer S2694 Order No. WC1-358-9452

Hardware Key

- Bolt or Stud 1/2-13
- ⊙ Threaded Hole 3/8-16 Blind Nut on Bead Plates 1/2-13 Pistons
- ⊗ Air Inlet 1/4 N.P.T.
- ⊕ No Alignment Specified-Center Stud Mounting is Standard
- ⊗ Combination Stud/Air Inlet Stud Outside Thread is 3/4-16
- ⊕ Studs Inside Thread (Air Inlet) is 1/4 N.P.T. Exceptions Will Be Noted on Part View as ⊗

1T - Reversible Sleeve

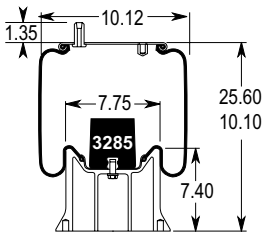
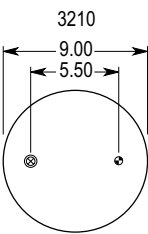
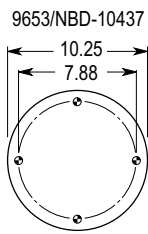
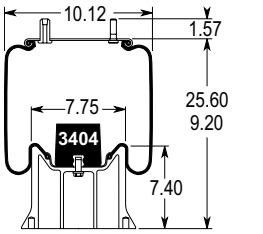
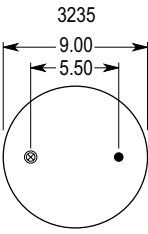
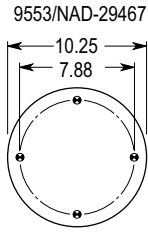
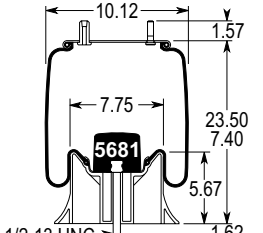
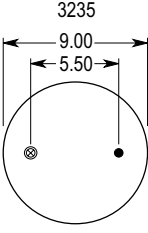
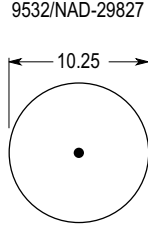
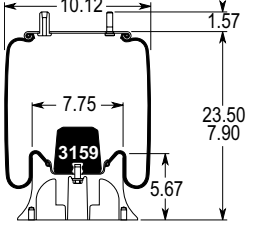
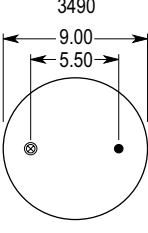
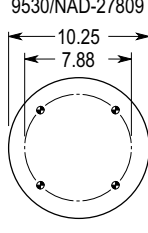
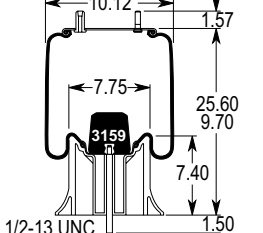
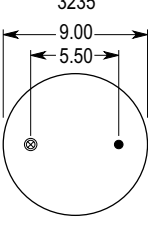
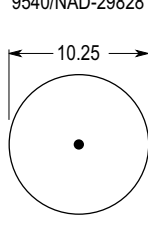
BELLOW NO. ASSEMBLY ORDER NO.	CROSS SECTION VIEW	BEAD PLATE TOP VIEW	PISTON BOTTOM VIEW	ASSEMBLY WEIGHT (lbs.)	REPLACES
1T15M-9 W01-358-9238			 Order No. WC1-358-9453	16.4	Hendrickson Trailer S5060
1T15M-9 W01-358-9240			 Order No. WC1-358-9453	16.6	Hendrickson Trailer S3842 Hendrickson Can. S10352
1T15M-9 W01-358-9243			 Order No. WC1-358-1619	14.4	Holland (Neway) 900557112 (AR90-[All]) (ARU92-9&10) Watson & Chalin AS-0061
1T15M-9 W01-358-9245 SERVICE ASSEMBLY W01-358-9102			 Order No. WC1-358-9452	15.8	Ridewell 1003589245C
1T15M-9 W01-358-9346 SERVICE ASSEMBLY W01-358-9102			 Order No. WC1-358-0664	16.6	Holland (Neway) 90557126 (AR-75-12) (AR-75-1-12) (ARU92-12) Watson & Chalin AS-0056

1T Style Springs

Hardware Key

- Bolt or Stud 1/2-13 ⊙ Threaded Hole 3/8-16 Blind Nut on Bead Plates 1/2-13 Pistons ⊗ Air Inlet 1/4 N.P.T. No Alignment Specified-Center Stud Mounting is Standard
- ⊗ Combination Stud/Air Inlet Stud Outside Thread is 3/4-16 Studs Inside Thread (Air Inlet) is 1/4 N.P.T. Exceptions Will Be Noted on Part View as ⊗

Firestone

BELLOW NO. ASSEMBLY ORDER NO.	CROSS SECTION VIEW	BEAD PLATE TOP VIEW	PISTON BOTTOM VIEW	ASSEMBLY WEIGHT (lbs.)	REPLACES
1T15M-9 W01-358-9348			9553/NAD-29467 Order No. WC1-358-9453	16.9	CCG McCullough Trailer
1T15M-9 W01-358-9349			9553/NAD-29467 Order No. WC1-358-9453	19.8	Hendrickson Trailer S8988 Reyco 17636-01
1T15M-9 W01-358-9350			9553/NBD-29467 Order No. WC1-358-9453	14.6	Watson & Chalin
1T15M-9 W01-358-9394			9553/NBD-29467 (use) Order No. WC1-358-9453	16.5	Fruehauf UCD-9393-2 (-if bolt is removed, this part can replace the UCE-9393-1) Suspensions Inc. 200041 supersedes 9241
1T15M-9 W01-358-9875			9538 NAD-27740 	15.4	Navistar 3541731C1

Hardware Key

- Bolt or Stud 1/2-13 ● Threaded Hole 3/8-16 Blind Nut on Bead Plates 1/2-13 Pistons ⊗ Air Inlet 1/4 N.P.T. No Alignment Specified-Center Stud Mounting is Standard
- ⊗ Combination Stud/Air Inlet Stud Outside Thread is 3/4-16 Studs Inside Thread (Air Inlet) is 1/4 N.P.T. Exceptions Will Be Noted on Part View as ⊗

1T - Reversible Sleeve

BELLOW NO. ASSEMBLY ORDER NO.	CROSS SECTION VIEW	BEAD PLATE TOP VIEW	PISTON BOTTOM VIEW	ASSEMBLY WEIGHT (lbs.)	REPLACES
1T15M-9				15.4	Navistar 3541732C1
W01-358-9876					
1T15MM-9				18.0	Hendrickson Trailer S20124 Hendrickson Trailer HT-250T Hendrickson Trailer C20413 (rotate piston to 45i alignment) Hendrickson Trailer HT-250U (all others) Hendrickson Trailer HT-250U-Y (9Y-001)
W01-358-9265					
WILL BECOME 1T15MW-10					
1T15MB-TW-10				14.4	Hendrickson Trailer S23611
W01-358-9646					
1T15M-11				17.3	Holland (Neway) 90557099 Silent Drive
W01-358-9320					
1T15M-11				19.8	Watson & Chalin AS-0036
W01-358-9321					
Hardware Key ● Bolt or Stud 1/2-13 ◐ Threaded Hole 3/8-16 Blind Nut on Bead Plates 1/2-13 Pistons ⊗ Air Inlet 1/4 N.P.T. No Alignment Specified-Center Stud Mounting is Standard ⊕ Combination Stud/Air Inlet Stud Outside Thread is 3/4-16 Studs Inside Thread (Air Inlet) is 1/4 N.P.T. Exceptions Will Be Noted on Part View as ⊗					

1T Style Springs

Firestone

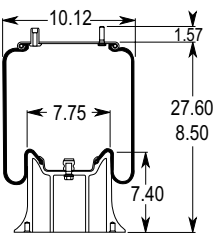
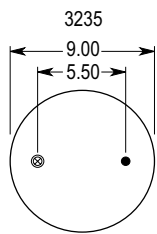
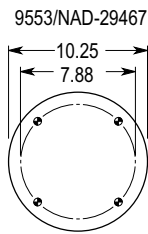
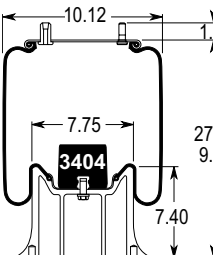
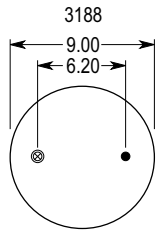
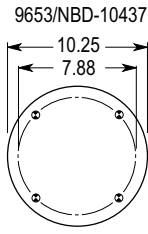
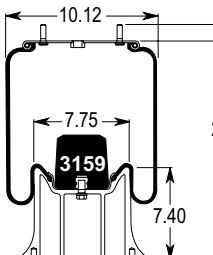
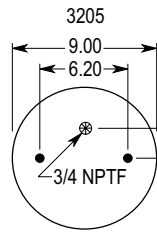
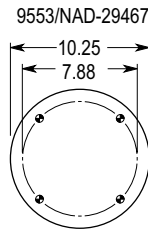
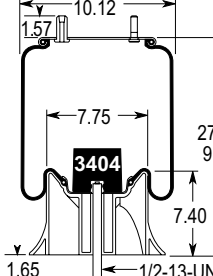
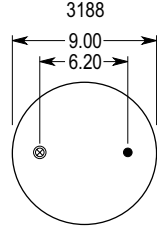
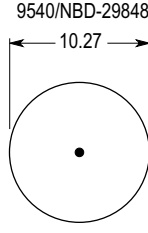
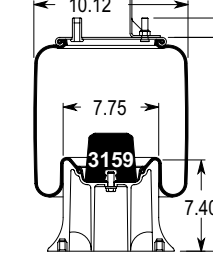
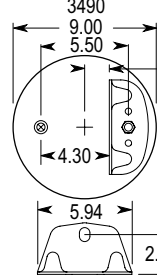
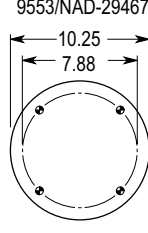
BELLOW NO. ASSEMBLY ORDER NO.	CROSS SECTION VIEW	BEAD PLATE TOP VIEW	PISTON BOTTOM VIEW	ASSEMBLY WEIGHT (lbs.)	REPLACES
1T15M-11 W01-358-9338			 Order No. WC1-358-9453	18.2	Silent Drive
1T15M-11 W01-358-9367			 Order No. WC1-358-9453	20.4	Hendrickson S14249 (W01-455-9321) Hendrickson Aux. 003319 (metric equivalent)
1T15M-11 W01-358-9368			 Order No. WC1-358-9453	20.7	Ridewell 1003589368C
1T15M-11 W01-358-9370			 Order No. WC1-358-0664	17.0	Watson & Chalin AS-0057
1T15M-11 W01-358-9538 BRACKET WC1-358-3906			 Order No. WC1-358-9453	18.2	Ridewell 1003589538C

Hardware Key

- Bolt or Stud 1/2-13 ⊗ Threaded Hole 3/8-16 Blind Nut on Bead Plates 1/2-13 Pistons ⊗ Air Inlet 1/4 N.P.T. No Alignment Specified-Center Stud Mounting is Standard
- ⊗ Combination Stud/Air Inlet Stud Outside Thread is 3/4-16 Studs Inside Thread (Air Inlet) is 1/4 N.P.T. Exceptions Will Be Noted on Part View as ⊗

1T - Reversible Sleeve

BELLOW NO. ASSEMBLY ORDER NO.	CROSS SECTION VIEW	BEAD PLATE TOP VIEW	PISTON BOTTOM VIEW	ASSEMBLY WEIGHT (lbs.)	REPLACES
1T15M-11				18.2	Hendrickson Aux. 003319 (Same as SAE version W01-358-9367)
W01-358-9668 METRIC					
1T15MB-TW-12				16.3	Hendrickson Trailer S23612
W01-358-9645					
1T15SN-3				12.9	Rockwell
W01-358-8911					
1T15SN-6				13.2	Jet Co. (10.30 max. OD) Bolt removed for center mounting
W01-358-9260					
1T15T-1				11.5	Capacity of Texas
W01-358-9402					

1T Style Springs

Hardware Key

- Bolt or Stud 1/2-13 ⊗ Threaded Hole 3/8-16 Blind Nut on Bead Plates 1/2-13 Pistons ⊗ Air Inlet 1/4 N.P.T. No Alignment Specified-Center Stud Mounting is Standard
- ⊗ Combination Stud/Air Inlet Stud Outside Thread is 3/4-16 Studs Inside Thread (Air Inlet) is 1/4 N.P.T. Exceptions Will Be Noted on Part View as ⊗

Firestone

BELLOW NO. ASSEMBLY ORDER NO.	CROSS SECTION VIEW	BEAD PLATE TOP VIEW	PISTON BOTTOM VIEW	ASSEMBLY WEIGHT (lbs.)	REPLACES
1T15T-1 W01-358-9410				9.8	Columbia Trailer
1T15T-1 W01-358-9650				12.3	Holland (Neway) 90557097
1T15T-1 W01-358-9651				9.8	Monaco Coach 01806160
1T15T-1 W01-358-5765				11.9	American Carrier 8003-024
1T15T-1 W01-358-5766				12.1	American Carrier 8003-023 Hutchens 19141-01

Hardware Key

- Bolt or Stud 1/2-13
- ⊙ Threaded Hole 3/8-16 Blind Nut on Bead Plates 1/2-13 Pistons
- ⊗ Air Inlet 1/4 N.P.T.
- ⊕ No Alignment Specified-Center Stud Mounting is Standard
- ⊗ Combination Stud/Air Inlet Stud Outside Thread is 3/4-16
- ⊕ Studs Inside Thread (Air Inlet) is 1/4 N.P.T. Exceptions Will Be Noted on Part View as ⊗

1T - Reversible Sleeve

BELLOW NO. ASSEMBLY ORDER NO.	CROSS SECTION VIEW	BEAD PLATE TOP VIEW	PISTON BOTTOM VIEW	ASSEMBLY WEIGHT (lbs.)	REPLACES
1T15T-1			9505/NBD-14537 Order No. WC1-358-1642	10.1	American Carrier 8003-003
W01-358-9421					
1T15T-1			9655/NBD-10439 Order No. WC1-358-9454	13.0	Ridewell 1003589423C
W01-358-9423					
1T15TQ-1			9681/NBD-14213 Order No. WC1-358-1612	11.2	Ridewell 1003585770C Watson & Chalin AS-0042
W01-358-5770					
1T15TQ-1			9681/NBD-14213 Order No. WC1-358-1612	12.2	Brock
W01-358-5771					
1T15TQ-1			9681/NBD-14213 Order No. WC1-358-1612	9.4	Brock Link (see 5789)
W01-358-5772					

1T Style Springs

Hardware Key

- Bolt or Stud 1/2-13 ● Threaded Hole 3/8-16 Blind Nut on Bead Plates 1/2-13 Pistons ⊗ Air Inlet 1/4 N.P.T. No Alignment Specified-Center Stud Mounting is Standard
- ⊗ Combination Stud/Air Inlet Stud Outside Thread is 3/4-16 Studs Inside Thread (Air Inlet) is 1/4 N.P.T. Exceptions Will Be Noted on Part View as ⊗

Firestone

BELLOW NO. ASSEMBLY ORDER NO.	CROSS SECTION VIEW	BEAD PLATE TOP VIEW	PISTON BOTTOM VIEW	ASSEMBLY WEIGHT (lbs.)	REPLACES
1T15TQ-1 W01-358-5773				9.8	Kenworth
			Order No. WC1-358-1612		
1T15TQ-1 W01-358-5775				11.9	Reyco 20783-01
			Order No. WC1-358-1612		
1T15TQ-1 W01-358-5776 BRACKET WC1-358-3887				11.6	Holland (Neway) 90557174 (AS 120) ref. W01-358-9586 (1/2ONPT)
			Order No. WC1-358-1612		
1T15TQ-1 W01-358-5777				11.1	Reyco 22425-01
			Order No. WC1-358-1612		
1T15TQ-1 W01-358-5789				11.2	Link 1103-0503 Ultraride
			Order No. WC1-358-1612		

Hardware Key

- Bolt or Stud 1/2-13
- ⊕ Threaded Hole 3/8-16 Blind Nut on Bead Plates 1/2-13 Pistons
- ⊗ Air Inlet 1/4 N.P.T.
- ⊙ No Alignment Specified-Center Stud Mounting is Standard
- ⊗ Combination Stud/Air Inlet Stud Outside Thread is 3/4-16
- ⊙ Studs Inside Thread (Air Inlet) is 1/4 N.P.T. Exceptions Will Be Noted on Part View as ⊗

1T - Reversible Sleeve

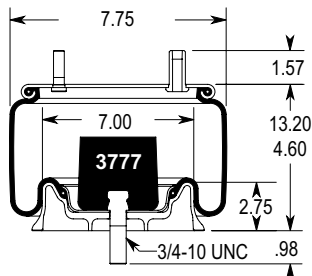
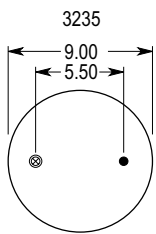
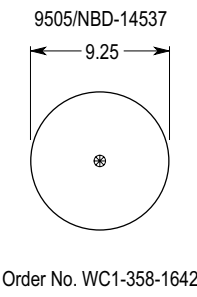
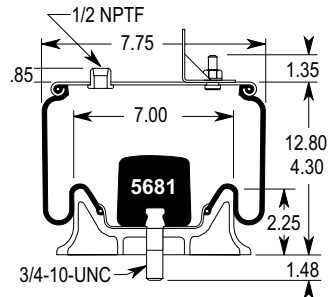
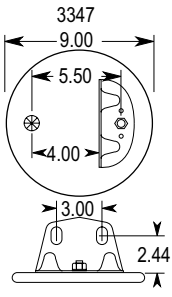
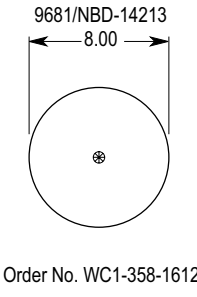
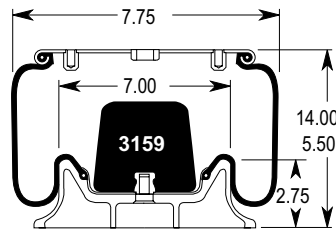
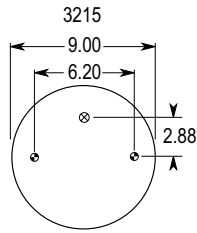
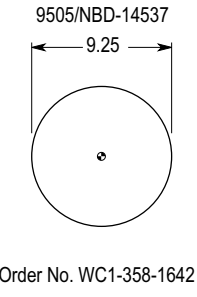
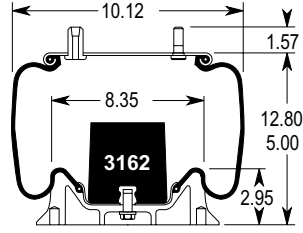
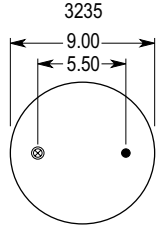
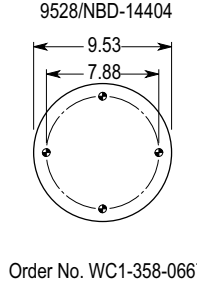
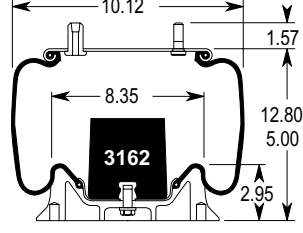
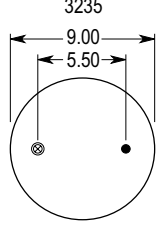
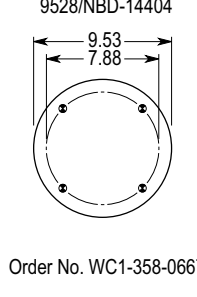
BELLOW NO. ASSEMBLY ORDER NO.	CROSS SECTION VIEW	BEAD PLATE TOP VIEW	PISTON BOTTOM VIEW	ASSEMBLY WEIGHT (lbs.)	REPLACES
1T15TQ-1 W01-358-5792				11.4	Ridewell 1003585792C
1T15TQ-1 W01-358-9586 BRACKET WC1-358-3887				11.7	Holland (Neway) 90557249 replaces Holland (Neway) 90557221 (1/20 NPT-flush) (ref.W01-358-5776)
1T15T-2 W01-358-8600				11.5	Capacity of Texas
1T15V-1 W01-358-9249				12.3	Holland (Neway) 90557107 Suspension Inc. 201150 Suspension Dynam- ics 55015
1T15V-1 W01-358-9251				12.3	Ridewell 1003589251C Suspensions 200182

1T Style Springs

Hardware Key

- Bolt or Stud 1/2-13 ◐ Threaded Hole 3/8-16 Blind Nut on Bead Plates 1/2-13 Pistons ⊗ Air Inlet 1/4 N.P.T. No Alignment Specified-Center Stud Mounting is Standard
- ⊗ Combination Stud/Air Inlet Stud Outside Thread is 3/4-16 Studs Inside Thread (Air Inlet) is 1/4 N.P.T. Exceptions Will Be Noted on Part View as ⊗

Firestone

BELLOW NO. ASSEMBLY ORDER NO.	CROSS SECTION VIEW	BEAD PLATE TOP VIEW	PISTON BOTTOM VIEW	ASSEMBLY WEIGHT (lbs.)	REPLACES
1T15V-3 W01-358-9578				11.7	Holland (Neway) 90557232
1T15V-3 W01-358-9582 SPACER WC1-358-3701				13.0	Holland (Neway) 90557240 REPLACEMENT PISTON DOES NOT INCLUDE SPACER
1T15VP-4 W01-358-9270 (WAS 1T15VM-4)				14.8	Hendrickson S-20010 (HT230T) ref.S21208 W01- 455-9579 (different bead plate) Also replaces 1T15VM-4.0
1T15VP-4 W01-358-9579				14.8	Hendrickson Trailer S21208
1T15V-8 W01-358-9274				19.0	Ridewell 1003589274C

Hardware Key

- Bolt or Stud 1/2-13 ⊗ Threaded Hole 3/8-16 Blind Nut on Bead Plates 1/2-13 Pistons ⊗ Air Inlet 1/4 N.P.T. No Alignment Specified-Center Stud Mounting is Standard
- ⊗ Combination Stud/Air Inlet Stud Outside Thread is 3/4-16 Studs Inside Thread (Air Inlet) is 1/4 N.P.T. Exceptions Will Be Noted on Part View as ⊗

1T - Reversible Sleeve

BELLOW NO. ASSEMBLY ORDER NO.	CROSS SECTION VIEW	BEAD PLATE TOP VIEW	PISTON BOTTOM VIEW	ASSEMBLY WEIGHT (lbs.)	REPLACES
1T15V-8				19.0	Ridewell 1003589275C
W01-358-9275					
1T15V-8				16.2	Holland (Neway) 90557145 (AD-246) Holland (Neway) 90557211 (2 bolt mounting on piston)
W01-358-9470 BRACKET WC1-358-3887					
1T15V-8				17.8	Holland (Neway) (AD-123/246-10) 90557146 90557182 (no bracket) 90557177 (special lower connection) Holland (Neway) 90557212 (146) Holland (Neway) 90557214 (182) (2 bolt mounting on piston)
W01-358-9471 BRACKET WC1-358-3887					
1T15V-8				16.2	Holland (Neway) 90557147 (AD- 123/246-6.5 & 8.75) 90557213 (147) (2 bolt mounting on piston) 90557178-Ford (special lower con- nection)
W01-358-9472 BRACKET WC1-358-3887					
1T15V-8				18.0	Holland (Neway) 90557152 Holland (Neway) 90557179 (no bracket) Holland (Neway) 90557215 (152) Holland (Neway) 90557216 (179) (2 bolt mounting on piston)
W01-358-9473 BRACKET WC1-358-3887					

1T Style Springs

Hardware Key

- Bolt or Stud 1/2-13 ⊗ Threaded Hole 3/8-16 Blind Nut on Bead Plates 1/2-13 Pistons ⊗ Air Inlet 1/4 N.P.T. No Alignment Specified-Center Stud Mounting is Standard
- ⊗ Combination Stud/Air Inlet Stud Outside Thread is 3/4-16 Studs Inside Thread (Air Inlet) is 1/4 N.P.T. Exceptions Will Be Noted on Part View as ⊗

Firestone

BELLOW NO. ASSEMBLY ORDER NO.	CROSS SECTION VIEW	BEAD PLATE TOP VIEW	PISTON BOTTOM VIEW	ASSEMBLY WEIGHT (lbs.)	REPLACES
1T15V-8 W01-358-9491 BRACKET WC1-358-3887			9727/NBD-8725 Order No. WC1-358-0651	18.4	Holland (Neway) 90557206 REPLACEMENT PISTON COMES WITHOUT STUDS
1T15V-8 W01-358-9501			9553/NAD-29467 Order No. WC1-358-9453	17.6	Holland 90557214 REPLACEMENT PISTON COMES WITHOUT STUDS
1T15V-8 W01-358-9502			9530/NAD-27908 Order No. WC1-358-9452	16.2	Holland 90557211 REPLACEMENT PISTON COMES WITHOUT STUDS
1T15V-8 W01-358-9504			9530/NAD-29467 Order No. WC1-358-9453	17.9	Holland 90557216
1T15VMW-8 W01-358-6258			9557/NAD-31181 Order No. WC1-358-1654	14.7	Arvin Meritor 21227892 FS25

Hardware Key

- Bolt or Stud 1/2-13
- ⊙ Threaded Hole 3/8-16 Blind Nut on Bead Plates 1/2-13 Pistons
- ⊗ Air Inlet 1/4 N.P.T.
- ⊕ No Alignment Specified-Center Stud Mounting is Standard
- ⊗ Combination Stud/Air Inlet Stud Outside Thread is 3/4-16
- ⊕ Studs Inside Thread (Air Inlet) is 1/4 N.P.T. Exceptions Will Be Noted on Part View as ⊗

1T - Reversible Sleeve

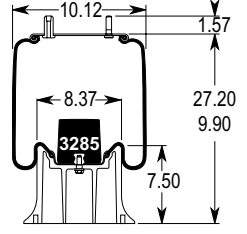
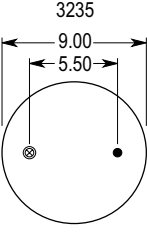
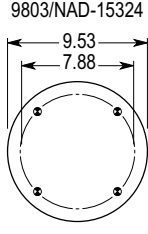
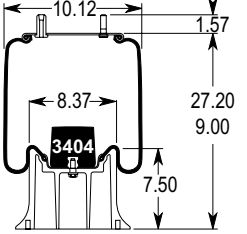
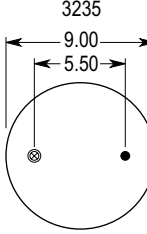
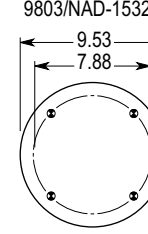
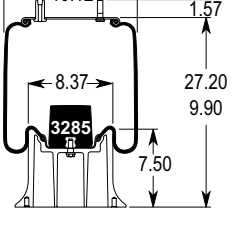
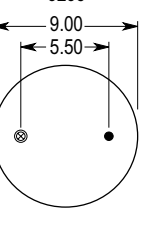
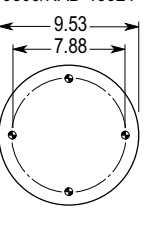
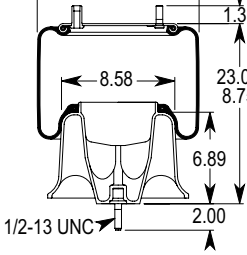
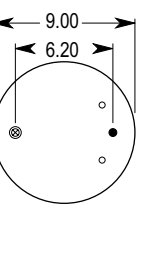
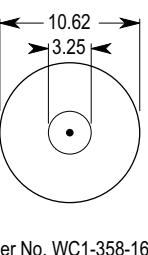
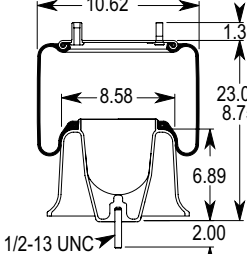
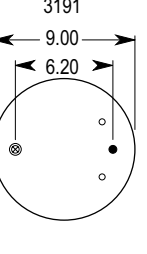
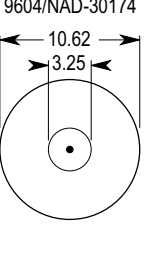
BELLOW NO. ASSEMBLY ORDER NO.	CROSS SECTION VIEW	BEAD PLATE TOP VIEW	PISTON BOTTOM VIEW	ASSEMBLY WEIGHT (lbs.)	REPLACES
1T15V-11 W01-358-9250			 Order No. WC1-358-0680	23.7	Ridewell 1003589250C Silent Drive
1T15V-11 W01-358-9252			 Order No. WC1-358-0680	23.3	Ridewell 1003589252C
1T15V-11 W01-358-9269			 Order No. WC1-358-0680	23.5	Oshkosh RX-08-03
1T15ZR-6 W01-358-9780			 Order No. WC1-358-1627	16.6	Freightliner 16-13810-000 (plastic) Freightliner 681-320-0017 (aluminum) See W01-358-9781 Freightliner Piston 16-1673-000 (steel) See W01-358-9782
1T15ZR-6 W01-358-9781			 Order No. WC1-358-1624	17.0	Freightliner 681-320-0017, A16-14004-000 (aluminum) Freightliner Piston 16-13840-000 (plastic) - See W01-358-9780 Freightliner Piston 16-1673-000 (steel) - See W01-358-9782

1T Style Springs

Hardware Key

- Bolt or Stud 1/2-13 ⊗ Threaded Hole 3/8-16 Blind Nut on Bead Plates 1/2-13 Pistons ⊗ Air Inlet 1/4 N.P.T. No Alignment Specified-Center Stud Mounting is Standard
- ⊗ Combination Stud/Air Inlet Stud Outside Thread is 3/4-16 Studs Inside Thread (Air Inlet) is 1/4 N.P.T. Exceptions Will Be Noted on Part View as ⊗

Firestone

BELLOW NO. ASSEMBLY ORDER NO.	CROSS SECTION VIEW	BEAD PLATE TOP VIEW	PISTON BOTTOM VIEW	ASSEMBLY WEIGHT (lbs.)	REPLACES
1T15ZR-6			9676/NAD-31612 Order No. N/A	20.7	Freightliner Custom Chassis 16-16773-000 Steel Piston 681-320-0017 Alum. Piston See W01-358-9781 16-13810-000 Plastic Piston See W01-358-9780
W01-358-9782					
BRACKET			6013/NAD-33041 Order No. N/A	N/A	Freightlin-
WC1-358-3874					
BRACKET			6012/NAD-33042 Order No. N/A	N/A	Freightliner 16-17010-002A16-18334-001
WC1-358-3876					
BRACKET			6033/NBD-13722 Order No. N/A	N/A	Freightliner A16-14004-000 (aluminum) 9781 Freightliner 16-13810-001 (plastic) 9780 Add bracket to 9780 or 9781
WC1-358-3900					
BRACKET			6034/NBD-13721 Order No. N/A	N/A	Freightliner A16-14004-001 (aluminum) Freightliner 16-13810-002 (plastic) (cabover) Add bracket to 9780 or 9781
WC1-358-3901					

Hardware Key

- Bolt or Stud 1/2-13
- ◐ Threaded Hole 3/8-16 Blind Nut on Bead Plates 1/2-13 Pistons
- ⊗ Air Inlet 1/4 N.P.T.
- ⊗ No Alignment Specified-Center Stud Mounting is Standard
- ⊗ Combination Stud/Air Inlet Stud Outside Thread is 3/4-16
- ⊗ Studs Inside Thread (Air Inlet) is 1/4 N.P.T. Exceptions Will Be Noted on Part View as ⊗

1T - Reversible Sleeve

BELLOW NO. ASSEMBLY ORDER NO.	CROSS SECTION VIEW	BEAD PLATE TOP VIEW	PISTON BOTTOM VIEW	ASSEMBLY WEIGHT (lbs.)	REPLACES
1T17AZR-4.5 W01-358-8676			9671/NAD-32590 Order No. N/A	N/A	Holland 90557314
1T17AEZR-5 W01-358-8632 OBSOLETE			9671/NAD-32590 Order No. N/A	N/A	Freightliner Custom Chassis 16-17315-000 ZF-IFS
1T17BB-2 W01-358-8729			9533/NAD-30515 Order No. WC1-358-1635	13.2	Meritor 202796 (GY 1R13-130)
1T17B-5 W01-358-8723			9603/NAD-29630 Order No. WC1-358-1635	15.2	
1T17B-5 W01-358-8740			9602/NAD-28351 Order No. WC1-358-1613	15.2	Reyco 23433-01

1T Style Springs

Hardware Key

- Bolt or Stud 1/2-13 ⊙ Threaded Hole 3/8-16 Blind Nut on Bead Plates 1/2-13 Pistons ⊗ Air Inlet 1/4 N.P.T. No Alignment Specified-Center Stud Mounting is Standard
- ⊗ Combination Stud/Air Inlet Stud Outside Thread is 3/4-16 Studs Inside Thread (Air Inlet) is 1/4 N.P.T. Exceptions Will Be Noted on Part View as ⊗

Firestone

BELLOW NO. ASSEMBLY ORDER NO.	CROSS SECTION VIEW	BEAD PLATE TOP VIEW	PISTON BOTTOM VIEW	ASSEMBLY WEIGHT (lbs.)	REPLACES
1T17B-5 W01-358-8751 OBSOLETE REPLACED BY W01-358-8709			<p>Order No. WC1-358-1609</p>	15.3	Hendrickson S20900 (Intraax AA230) [Up to 7/97] -replaced by W01-358-8709 (approx. 6/98) 1T17CA-5
1T17B-5 W01-358-8752			<p>Order No. WC1-358-1613</p>	15.3	Watson & Chalin AS-0084 Ridewell 1003588752C Suspensions Inc. 201642 [piston mounting may vary with GY bag-7.870BC]
1T17B-5 W01-358-8753			<p>Order No. WC1-358-1613</p>	15.4	Ridewell 1003588753C Watson & Chalin AS-0098
1T17B-5 W01-358-8755			<p>Order No. WC1-358-1610</p>	17.1	Hendrickson Trailer S22045 (HK190T) Hendrickson Trailer Prototype C21623
1T17B-5 W01-358-8756			<p>Order No. WC1-358-1611</p>	18.9	Hendrickson Trailer S22046 (HK230) -will be replaced by W01-358-8710 1T17CL-5 Hendrickson Trailer Prototype C21624

Hardware Key

- Bolt or Stud 1/2-13
- ⊙ Threaded Hole 3/8-16 Blind Nut on Bead Plates 1/2-13 Pistons
- ⊗ Air Inlet 1/4 N.P.T.
- ⊕ No Alignment Specified-Center Stud Mounting is Standard
- ⊗ Combination Stud/Air Inlet Stud Outside Thread is 3/4-16
- ⊙ Studs Inside Thread (Air Inlet) is 1/4 N.P.T. Exceptions Will Be Noted on Part View as ⊗

1T - Reversible Sleeve

BELLOW NO. ASSEMBLY ORDER NO.	CROSS SECTION VIEW	BEAD PLATE TOP VIEW	PISTON BOTTOM VIEW	ASSEMBLY WEIGHT (lbs.)	REPLACES
1T17B-5			<p>Order No. WC1-358-1635</p>	15.6	Ridewell 1001R13109G
W01-358-8782					
1T17B-11			<p>Order No. WC1-358-0664</p>	16.5	Holland (Neway) 90557243
W01-358-8744					
1T17B-11			<p>Order No. WC1-358-1619</p>	16.0	Holland (Neway) 90557235
W01-358-8746					
1T17B-11			<p>Order No. WC1-358-1619</p>	16.0	Holland (Neway) 90557167 (AR250-14 & 15)
W01-358-8748					
1T17B-11			<p>Order No. WC1-358-0664</p>	18.0	Holland (Neway) 90557168 (AR250-12,16,17)
W01-358-8749					

1T Style Springs

Hardware Key

- Bolt or Stud 1/2-13 ⊙ Threaded Hole 3/8-16 Blind Nut on Bead Plates 1/2-13 Pistons ⊗ Air Inlet 1/4 N.P.T. No Alignment Specified-Center Stud Mounting is Standard
- ⊗ Combination Stud/Air Inlet Stud Outside Thread is 3/4-16 ⊕ Studs Inside Thread (Air Inlet) is 1/4 N.P.T. Exceptions Will Be Noted on Part View as ⊗

Firestone

BELLOW NO. ASSEMBLY ORDER NO.	CROSS SECTION VIEW	BEAD PLATE TOP VIEW	PISTON BOTTOM VIEW	ASSEMBLY WEIGHT (lbs.)	REPLACES
1T17BP-17 W01-358-8724 SERVICE ASSEMBLY 0761			9646/NAD-31215 Order No. N/A	38.9	Hendrickson Trailer S22697
1T17C-3 W01-358-8636			9603/NAD-29630 Order No. WC1-358-1635	14.7	Tuthill Granning 705951-01
1T17C-3 W01-358-8733			9603/NAD-29630 Order No. WC1-358-1635	15.0	Tuthill Granning 700999-01
1T17C-3 W01-358-8737			9528/NBD-14404 Order No. WC1-358-0667	14.5	Holland (Neway) 90557272 (NS225, NS450, WN225, NSH450)
1T17C-3 W01-358-8738			9528/NBD-14404 Order No. WC1-358-0667	12.8	Holland (Neway) 90557271 (NSH225, NSB225, RLU250)

Hardware Key

- Bolt or Stud 1/2-13
- ⊙ Threaded Hole 3/8-16 Blind Nut on Bead Plates 1/2-13 Pistons
- ⊗ Air Inlet 1/4 N.P.T.
- ⊕ No Alignment Specified-Center Stud Mounting is Standard
- ⊗ Combination Stud/Air Inlet Stud Outside Thread is 3/4-16
- ⊕ Studs Inside Thread (Air Inlet) is 1/4 N.P.T. Exceptions Will Be Noted on Part View as ⊗

1T - Reversible Sleeve

BELLOW NO. ASSEMBLY ORDER NO.	CROSS SECTION VIEW	BEAD PLATE TOP VIEW	PISTON BOTTOM VIEW	ASSEMBLY WEIGHT (lbs.)	REPLACES
1T17CA-3 W01-358-8614				20.5	Hendrickson Trailer S26773 Wilson Trailer
1T17CD-3 W01-358-8617				13.5	Arvin Meritor A2258-E-1461 RHP-55 Arvin Meritor 202796 Ride Sentry
1T17CA-5 W01-358-8709				14.1	Hendrickson Trailer S21800 (Intraax AA230) [8/97-up] -replaces W01-358-8751 (approx. 6/98)
1T17CL-5 W01-358-8710				17.5	Hendrickson Trailer S22046 (HK230) Approximate availability 1-98 - -replaces W01-358-8756
1T17CA-6.5 W01-358-8735				21.0	Granning 7901 (replaced W01-681-8770) [1T19F-7]

1T Style Springs

Hardware Key

- Bolt or Stud 1/2-13 ⊙ Threaded Hole 3/8-16 Blind Nut on Bead Plates 1/2-13 Pistons ⊗ Air Inlet 1/4 N.P.T. No Alignment Specified-Center Stud Mounting is Standard
- ⊗ Combination Stud/Air Inlet Stud Outside Thread is 3/4-16 Studs Inside Thread (Air Inlet) is 1/4 N.P.T. Exceptions Will Be Noted on Part View as ⊗

Firestone

BELLOW NO. ASSEMBLY ORDER NO.	CROSS SECTION VIEW	BEAD PLATE TOP VIEW	PISTON BOTTOM VIEW	ASSEMBLY WEIGHT (lbs.)	REPLACES
1T17CA-6 W01-358-8623 OBSOLETE			3882/NAD-31635 Order No. N/A	21.8	Hendrickson Trailer S27031
1T17CA-6.5 W01-358-8708			9537/NAD-29798 Order No. WC1-358-1637	15.2	Hendrickson Trailer S21966 (HKA200 Special) Hedrickson 28929
1T17CA-6.5 W01-358-8713			9537/NAD-29798 Order No. WC1-358-1637	15.7	Hendrickson Trailer S22948 (Van Traax) - Prior to 9/99- used 9525 piston w/ bumper spacer
1T17C-8 W01-M58-8712 METRIC			9690/NAD-28840 Order No. N/A	19.0	Hendrickson 59319-2
1T17CL-9.5 W01-358-9580 (WAS 1T15VLT-10.5)			9689/NAD-28838 Order No. WC1-358-1607	18.9	Hendrickson Trailer S20127 [HT-250U 9-006] [HT-250UY 9Y-006] replaces 1T15VLT-10.5 1T15V-11 W01-358-9262

OBSOLETE
NO LONGER AVAILABLE

Hardware Key

- Bolt or Stud 1/2-13
- ⊖ Threaded Hole 3/8-16 Blind Nut on Bead Plates 1/2-13 Pistons
- ⊗ Air Inlet 1/4 N.P.T.
- ⊙ No Alignment Specified-Center Stud Mounting is Standard
- ⊗ Combination Stud/Air Inlet Stud Outside Thread is 3/4-16
- ⊙ Studs Inside Thread (Air Inlet) is 1/4 N.P.T. Exceptions Will Be Noted on Part View as ⊗

1T - Reversible Sleeve

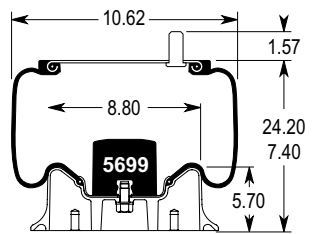
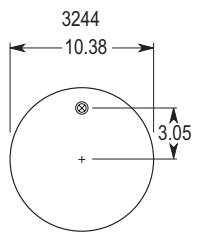
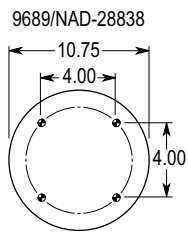
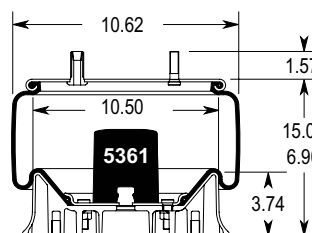
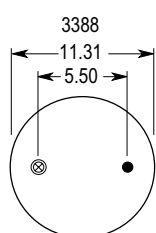
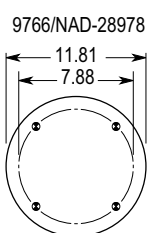
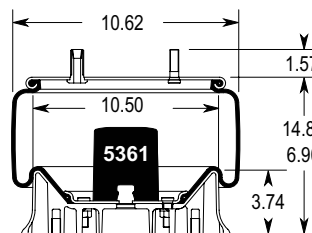
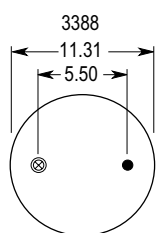
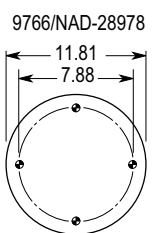
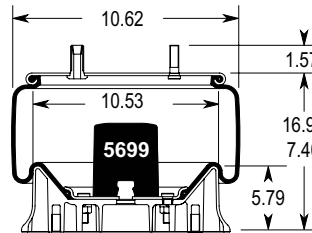
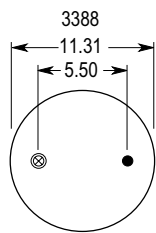
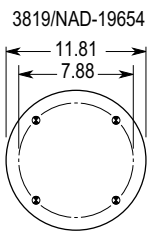
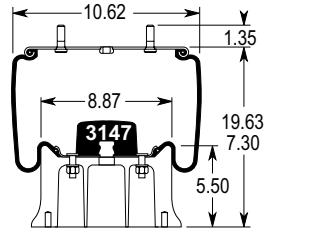
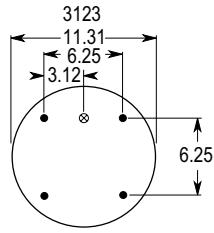
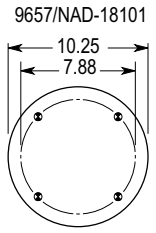
BELLOW NO. ASSEMBLY ORDER NO.	CROSS SECTION VIEW	BEAD PLATE TOP VIEW	PISTON BOTTOM VIEW	ASSEMBLY WEIGHT (lbs.)	REPLACES
1T17CL-9.5 W01-358-9581 (WAS 1T15VLT-10.5)			9689/NAD-28838 	19.0	Hendrickson Trailer S20414 [HT-250U (9-006)] [HT-250U-Y (9Y-006)] Replaces 1T15VLT-10.5 1T15V-11
			Order No. WC1-358-1607		
1T19L-3 W01-358-8760			9766/NAD-28978 	19.0	Granning 7593
			Order No. WC1-358-0631		
1T19L-3 W01-358-8761			9766/NAD-28978 	19.0	Tuthill Granning 702228-01
			Order No. WC1-358-0631		
1T19L-3 W01-358-8787			3819/NAD-19654 	20.8	Tuthill Granning 703667-01
			Order No. N/A		
1T19L-5 W01-358-8088			9657/NAD-18101 	21.9	Ridewell 1003588088C
			Order No. WC1-358-9450		

1T Style Springs

Hardware Key

- Bolt or Stud 1/2-13 ● Threaded Hole 3/8-16 Blind Nut on Bead Plates 1/2-13 Pistons ⊗ Air Inlet 1/4 N.P.T. No Alignment Specified-Center Stud Mounting is Standard
- ⊗ Combination Stud/Air Inlet Stud Outside Thread is 3/4-16 Studs Inside Thread (Air Inlet) is 1/4 N.P.T. Exceptions Will Be Noted on Part View as ⊗

Firestone

BELLOW NO. ASSEMBLY ORDER NO.	CROSS SECTION VIEW	BEAD PLATE TOP VIEW	PISTON BOTTOM VIEW	ASSEMBLY WEIGHT (lbs.)	REPLACES
1T19L-5 W01-358-8500				21.0	Rowe RV ASC1000/ ASC1001ASC1002/ ASC1003 Spartan
1T19L-5 W01-358-9200				21.7	Hendrickson Trailer S3839 Ridewell 1003589200C
1T19L-5 W01-358-9204				21.4	Ravens Trailer
1T19L-5 W01-358-9215				21.7	Hendrickson Trailer S3648
1T19L-5 W01-358-9216				22.5	City Welding

Hardware Key

- Bolt or Stud 1/2-13
- ⊙ Threaded Hole 3/8-16 Blind Nut on Bead Plates 1/2-13 Pistons
- ⊗ Air Inlet 1/4 N.P.T.
- ⊕ No Alignment Specified-Center Stud Mounting is Standard
- ⊗ Combination Stud/Air Inlet Stud Outside Thread is 3/4-16
- ⊕ Studs Inside Thread (Air Inlet) is 1/4 N.P.T. Exceptions Will Be Noted on Part View as ⊗

1T - Reversible Sleeve

BELLOW NO. ASSEMBLY ORDER NO.	CROSS SECTION VIEW	BEAD PLATE TOP VIEW	PISTON BOTTOM VIEW	ASSEMBLY WEIGHT (lbs.)	REPLACES
1T19L-5				21.4	Ridewell 1003589218C Holland (Neway) 90557209 Suspensions Inc. Watson & Chalin AS-0073 Rowe RV ASC1000/ ASC1001/ASC1002/ ASC1003 Spartan
W01-358-9218					
1T19L-5				21.8	Ridewell 1003589277C Reyco 24556-01
W01-358-9277					
1T19LC-5				21.4	Ag Chem Ag Chem
W01-358-8092					
1T19LC-5				14.4	John Deere AN205761
W01-M58-8798					
1T19LC-6				17.9	Hendrickson Trailer S20901 (Intraax 250) -reuse metal disk Hendrickson Trailer S21784 w/metal disk for piston support
W01-358-8091 (WAS 1T19FC-5)					

1T Style Springs

Hardware Key

- Bolt or Stud 1/2-13 ● Threaded Hole 3/8-16 Blind Nut on Bead Plates 1/2-13 Pistons ⊗ Air Inlet 1/4 N.P.T. No Alignment Specified-Center Stud Mounting is Standard
- ⊗ Combination Stud/Air Inlet Stud Outside Thread is 3/4-16 Studs Inside Thread (Air Inlet) is 1/4 N.P.T. Exceptions Will Be Noted on Part View as ⊗

Firestone

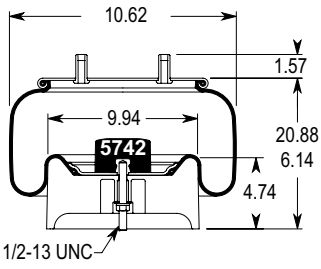
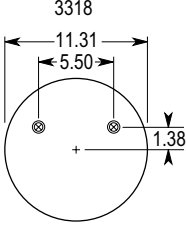
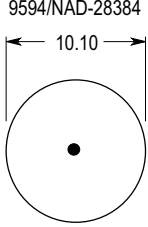
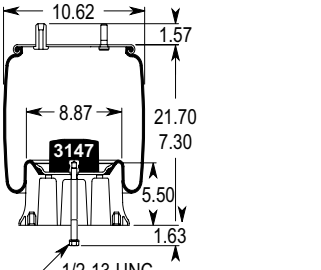
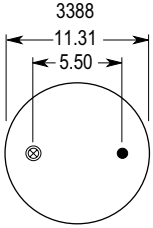
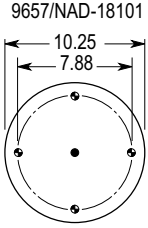
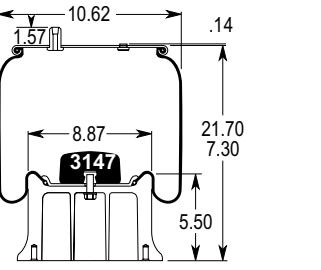
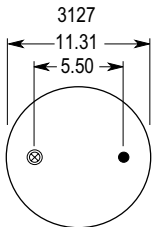
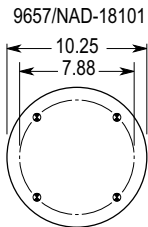
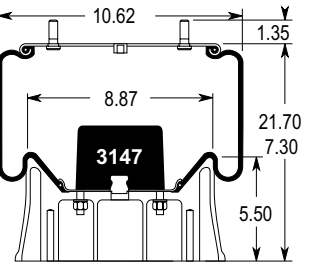
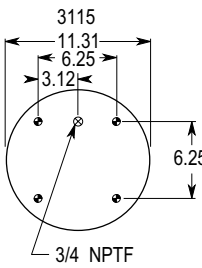
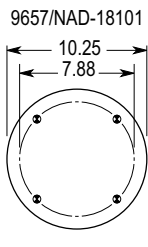
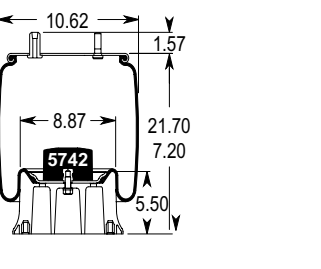
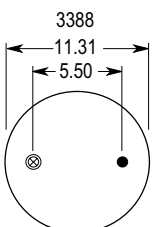
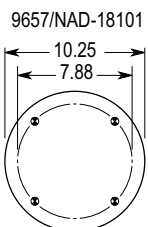
BELLOW NO. ASSEMBLY ORDER NO.	CROSS SECTION VIEW	BEAD PLATE TOP VIEW	PISTON BOTTOM VIEW	ASSEMBLY WEIGHT (lbs.)	REPLACES
1T19LF-7 W01-358-8774			 Order No. WC1-358-1614	18.0	Hendrickson Trailer S25873 Replacement piston comes without mounting plate
1T19L-7 W01-358-8776			 Order No. WC1-358-9450	22.8	Reyco 21767-01
1T19L-7 W01-358-8778			 Order No. WC1-358-9450	22.7	Holland (Neway) 90557164
1T19L-7 W01-358-9116			 Order No. WC1-358-9450	22.7	Pezzani
1T19L-7 W01-358-9121			 Order No. WC1-358-9450	21.7	Holland (Neway) 90557019 Holland (Neway) 90557052 Holland (Neway) 90557078 Holland (Neway) 90557083 Holland (Neway) 90557110 (parallel alignment) R & S Truck & Body 1090023 Ridewell 1003589121C Sauer P50-733 Reyco 12882-02

Hardware Key

- Bolt or Stud 1/2-13
- ⊙ Threaded Hole 3/8-16 Blind Nut on Bead Plates 1/2-13 Pistons
- ⊗ Air Inlet 1/4 N.P.T.
- ⊕ No Alignment Specified-Center Stud Mounting is Standard
- ⊗ Combination Stud/Air Inlet Stud Outside Thread is 3/4-16
- ⊕ Studs Inside Thread (Air Inlet) is 1/4 N.P.T. Exceptions Will Be Noted on Part View as ⊗

1T - Reversible Sleeve

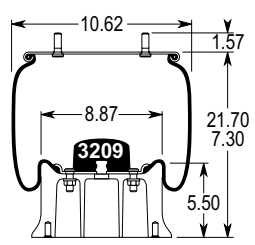
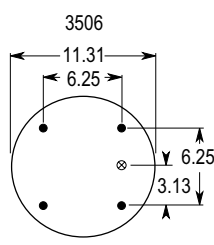
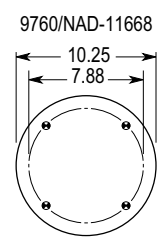
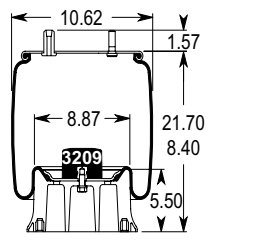
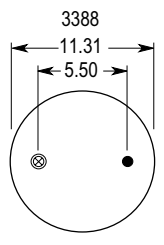
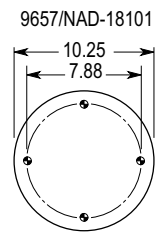
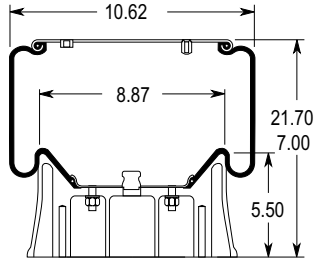
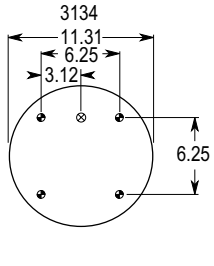
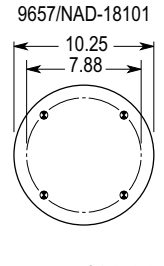
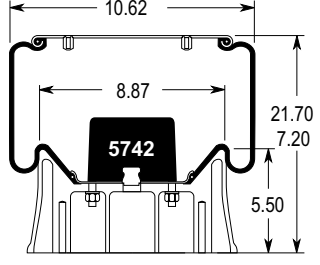
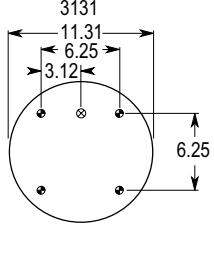
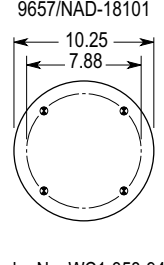
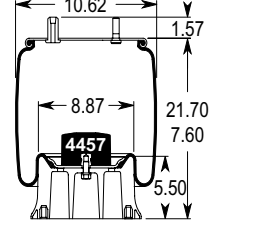
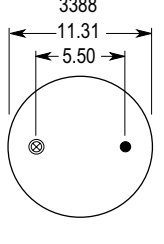
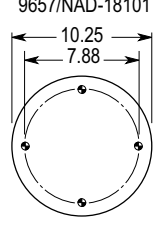
BELLOW NO. ASSEMBLY ORDER NO.	CROSS SECTION VIEW	BEAD PLATE TOP VIEW	PISTON BOTTOM VIEW	ASSEMBLY WEIGHT (lbs.)	REPLACES
1T19L-7 W01-358-9135				30.4	Dart 21-4048 Unit Rig 1016034 Order No. WC1-358-0675
1T19L-7 W01-358-9144				24.2	Holland (Neway) 90557155 Order No. WC1-358-9450
1T19L-7 W01-358-9148				20.9	Peerless 0550-00070 Order No. WC1-358-9450
1T19L-7 W01-358-9149				21.8	City Welding Peerless 0550-00010 Order No. WC1-358-9450
1T19L-7 W01-358-9164				23.2	R & S Truck & Body 1090326 Order No. WC1-358-9450

1T Style Springs

Hardware Key

- Bolt or Stud 1/2-13
- ⊗ Threaded Hole 3/8-16 Blind Nut on Bead Plates 1/2-13 Pistons
- ⊗ Air Inlet 1/4 N.P.T.
- ⊗ Combination Stud/Air Inlet Stud Outside Thread is 3/4-16
- ⊗ Studs Inside Thread (Air Inlet) is 1/4 N.P.T. Exceptions Will Be Noted on Part View as ⊗
- No Alignment Specified-Center Stud Mounting is Standard

Firestone

BELLOW NO. ASSEMBLY ORDER NO.	CROSS SECTION VIEW	BEAD PLATE TOP VIEW	PISTON BOTTOM VIEW	ASSEMBLY WEIGHT (lbs.)	REPLACES
1T19L-7 W01-358-9177			9657/NAD-18101 	21.8	Hendrickson Trailer S2065 R & S Truck & Body 1090216 Holland (Neway) 90557003 Ridewell 1003589177C Columbia Trailer
			Order No. WC1-358-9450		
1T19L-7 W01-358-9179			9657/NAD-18101 	22.5	Columbia Trailer Obsolete See W01-358-9177
			Order No. WC1-358-9450		
1T19L-7 W01-358-9221			9657/NAD-18101 	21.4	Load Air P60733
			Order No. WC1-358-9450		
1T19L-7 W01-358-9811			9766/NAD-28978 	19.0	Rowe Truck ASCC2000 Ride
			Order No. WC1-358-0631		
1T19L-7 W01-358-9961			9580/NAD-27909 	20.7	Ridewell 1003589961C
			Order No. WC1-358-0528		

Hardware Key

- Bolt or Stud 1/2-13
- ⊙ Threaded Hole 3/8-16 Blind Nut on Bead Plates 1/2-13 Pistons
- ⊗ Air Inlet 1/4 N.P.T.
- ⊕ No Alignment Specified-Center Stud Mounting is Standard
- ⊗ Combination Stud/Air Inlet Stud Outside Thread is 3/4-16
- ⊕ Studs Inside Thread (Air Inlet) is 1/4 N.P.T. Exceptions Will Be Noted on Part View as ⊗

1T - Reversible Sleeve

BELLOW NO. ASSEMBLY ORDER NO.	CROSS SECTION VIEW	BEAD PLATE TOP VIEW	PISTON BOTTOM VIEW	ASSEMBLY WEIGHT (lbs.)	REPLACES
1T19LC-8 W01-358-8093				21.2	Hendrickson Trailer S23748 (w/disk S24443)
1T19LE-8 W01-358-9825				22.1	Tuthill Granning 700135-01 Granning 8273
1T19L-9 W01-358-8779				19.9	Holland (Neway) 90557163
1T19L-9 W01-358-8780				19.9	Holland (Neway) 90557162
1T19L-9 W01-358-8781				21.5	Holland (Neway) 90557205

1T Style Springs

Hardware Key

- Bolt or Stud 1/2-13
- ⊗ Threaded Hole 3/8-16 Blind Nut on Bead Plates 1/2-13 Pistons
- ⊗ Air Inlet 1/4 N.P.T.
- No Alignment Specified-Center Stud Mounting is Standard
- ⊗ Combination Stud/Air Inlet Stud Outside Thread is 3/4-16
- ⊗ Studs Inside Thread (Air Inlet) is 1/4 N.P.T. Exceptions Will Be Noted on Part View as ⊗

Firestone

BELLOW NO. ASSEMBLY ORDER NO.	CROSS SECTION VIEW	BEAD PLATE TOP VIEW	PISTON BOTTOM VIEW	ASSEMBLY WEIGHT (lbs.)	REPLACES
1T19L-9 W01-358-9134			 Order No. WC1-358-9450	19.9	Holland (Neway) 90557125 (AR-80-9) (AR-80-9WST)
1T19L-9 W01-358-9138			 Order No. WC1-358-9450	19.9	Holland (Neway) 90557111 (AR-80-9FM)
1T19L-11 W01-358-8792			 Order No. WC1-358-1640	23.9	Aluminum version of W01-358-9122
1T19L-11 W01-358-8796			 Order No. WC1-358-0528	19.9	Holland (Neway) 90557283 RL300
1T19L-11 W01-358-9122			 Order No. WC1-358-0528	21.8	Hendrickson Trailer S3467, S3830 Holland (Neway) 90557020, 90557071, 90557076, 90557077 Hendrickson Can. B-12514-008, B-12514-010 Porcupine Reyco 12883-02 Sauer P50-732 Ridewell 1003589122C Temisko Watson & Chalin

Hardware Key

- Bolt or Stud 1/2-13
- ⊖ Threaded Hole 3/8-16 Blind Nut on Bead Plates 1/2-13 Pistons
- ⊗ Air Inlet 1/4 N.P.T.
- ⊕ No Alignment Specified-Center Stud Mounting is Standard
- ⊗ Combination Stud/Air Inlet Stud Outside Thread is 3/4-16
- ⊕ Studs Inside Thread (Air Inlet) is 1/4 N.P.T. Exceptions Will Be Noted on Part View as ⊗

1T - Reversible Sleeve

BELLOW NO. ASSEMBLY ORDER NO.	CROSS SECTION VIEW	BEAD PLATE TOP VIEW	PISTON BOTTOM VIEW	ASSEMBLY WEIGHT (lbs.)	REPLACES
1T19L-11 W01-358-9152 OBSOLETE REPLACED BY W01-358-9122		3123 	9580/NAD-27909 	21.6	Columbia Trailer Obsolete Use W01-358-9122
1T19L-11 W01-358-9156		3131 	9580/NAD-27909 	21.3	City Welding Peerless 0550-00080 Hendrickson Trailer S7128
1T19L-11 W01-358-9158		3506 	9580/NAD-27909 	21.8	Hendrickson Can. B-12514-004, B-12514-011 Holland (Neway) 90557005 Hendrickson Trailer S2063 Holland (Neway) 90557069 Peerless Ridewell 1003589158C Porcupine MFG.SV.# Neway 90044197
1T19L-11 W01-358-9199		3115 	9580/NAD-27909 	22.2	Pezzani
1T19L-11 W01-358-9201		3506 	9642/NAD-33001 	28.8	Ridewell 1003589201C

1T Style Springs

Hardware Key

- Bolt or Stud 1/2-13 ● Threaded Hole 3/8-16 Blind Nut on Bead Plates 1/2-13 Pistons ⊗ Air Inlet 1/4 N.P.T. No Alignment Specified-Center Stud Mounting is Standard
- ⊗ Combination Stud/Air Inlet Stud Outside Thread is 3/4-16 Studs Inside Thread (Air Inlet) is 1/4 N.P.T. Exceptions Will Be Noted on Part View as ⊗

Firestone

BELLOW NO. ASSEMBLY ORDER NO.	CROSS SECTION VIEW	BEAD PLATE TOP VIEW	PISTON BOTTOM VIEW	ASSEMBLY WEIGHT (lbs.)	REPLACES
1T19L-11 W01-358-9214				31.4	Granning 2598
1T19L-11 W01-358-9985				22.3	Watson & Chalin AS-0081
1T19L-11 W01-358-8764				20.1	Holland 90557260
1T19L-12 W01-358-5503				24.8	Holland (Neway) 90557200 Watson & Chalin AS-0047
1T19F-12 W01-358-5505				26.5	Holland (Neway) 90557103

Hardware Key

- Bolt or Stud 1/2-13
- ⊙ Threaded Hole 3/8-16 Blind Nut on Bead Plates 1/2-13 Pistons
- ⊗ Air Inlet 1/4 N.P.T.
- ⊕ No Alignment Specified-Center Stud Mounting is Standard
- ⊗ Combination Stud/Air Inlet Stud Outside Thread is 3/4-16
- ⊕ Studs Inside Thread (Air Inlet) is 1/4 N.P.T. Exceptions Will Be Noted on Part View as ⊗

1T - Reversible Sleeve

BELLOW NO. ASSEMBLY ORDER NO.	CROSS SECTION VIEW	BEAD PLATE TOP VIEW	PISTON BOTTOM VIEW	ASSEMBLY WEIGHT (lbs.)	REPLACES
1T19F-12 W01-358-5509				27.1	Suspension Inc.
1T19F-12 W01-358-5511				23.4	Holland (Neway) 90557102 Hendrickson Trailer S22173
1T19F-12 W01-358-9891				24.5	Holland (Neway) 90557218
1T19F-12 W01-358-8793				23.4	Holland (Neway) 90557270 AD-130
1T19L-14 W01-358-9264				26.9	Hendrickson Trailer S13122 [HT250U(9-020)] Holland (Neway) 90557104 Watson Chalin AS- 0063

1T Style Springs

Hardware Key

- Bolt or Stud 1/2-13 ⊗ Threaded Hole 3/8-16 Blind Nut on Bead Plates 1/2-13 Pistons ⊗ Air Inlet 1/4 N.P.T. No Alignment Specified-Center Stud Mounting is Standard
- ⊗ Combination Stud/Air Inlet Stud Outside Thread is 3/4-16 Studs Inside Thread (Air Inlet) is 1/4 N.P.T. Exceptions Will Be Noted on Part View as ⊗

Firestone

BELLOW NO. ASSEMBLY ORDER NO.	CROSS SECTION VIEW	BEAD PLATE TOP VIEW	PISTON BOTTOM VIEW	ASSEMBLY WEIGHT (lbs.)	REPLACES
1T19L-14				26.9	Holland (Neway) 90557104 Watson & Chalin AS-0063
W01-358-9915					
1T19L-14				26.9	Holland (Neway) 90557106
W01-358-9929					
1T19L-16				25.2	Neway 90557144 Rotate Piston: 90557133-28 De- grees RH90557134- 28 Degrees LH90557148 Parallel
W01-358-9896					
1T19L-16				25.7	Suspensions Inc. (Wabash) Hendrickson Trailer S20157
W01-358-9928					
1Y19LE-8					Tuthill Granning 700136-01
W01-358-9825					

Hardware Key

- Bolt or Stud 1/2-13
- ⊖ Threaded Hole 3/8-16 Blind Nut on Bead Plates 1/2-13 Pistons
- ⊗ Air Inlet 1/4 N.P.T.
- ⊕ No Alignment Specified-Center Stud Mounting is Standard
- ⊗ Combination Stud/Air Inlet Stud Outside Thread is 3/4-16
- ⊕ Studs Inside Thread (Air Inlet) is 1/4 N.P.T. Exceptions Will Be Noted on Part View as ⊗

1T - Reversible Sleeve

BELLOW NO. ASSEMBLY ORDER NO.	CROSS SECTION VIEW	BEAD PLATE TOP VIEW	PISTON BOTTOM VIEW	ASSEMBLY WEIGHT (lbs.)	REPLACES
1T19J-1				17.0	Ridewell 1003588055C
W01-358-8055					
1T19N-9				N/A	Watson & Chalin AS-0060
W01-358-9984					
1T19ZK-5.7				21.7	Hendrickson Trailer S4771
W01-358-8050 (WAS 1T19J-6)					
1T19ZK-5.7				21.7	Hendrickson Trailer S-4771 Hendrickson Canada B-12514-013 Tuthill Reyco 23631-01 Watson Chalin AS-0039
W01-358-8058 Supersedes 1T19J-6					
1T19ZK-5.7				21.7	Ridewell 1003588051C Hendrickson Can. B-12514-013 Tuthill-Reyco 23631-01 Watson & Chalin AS-0039 Supersedes 1T19J-6
W01-358-8051 (WAS 1T19J-6)					

1T Style Springs

Hardware Key

- Bolt or Stud 1/2-13 ⊙ Threaded Hole 3/8-16 Blind Nut on Bead Plates 1/2-13 Pistons ⊗ Air Inlet 1/4 N.P.T. No Alignment Specified-Center Stud Mounting is Standard
- ⊗ Combination Stud/Air Inlet Stud Outside Thread is 3/4-16 Studs Inside Thread (Air Inlet) is 1/4 N.P.T. Exceptions Will Be Noted on Part View as ⊗

Firestone

BELLOW NO. ASSEMBLY ORDER NO.	CROSS SECTION VIEW	BEAD PLATE TOP VIEW	PISTON BOTTOM VIEW	ASSEMBLY WEIGHT (lbs.)	REPLACES
1T19ZK-5.7 W01-358-8052 (WAS 1T19J-6)			<p>Order No. WC1-358-9999</p>	21.7	Hendrickson Can. B12514-012 Watson & Chalin AS-0078 Watson & Chalin AS-0039
1T19ZK-5.7 W01-358-8053 (WAS 1T19J-6)			<p>Order No. WC1-358-9999</p>	21.7	Holland (Neway) 90557098 (AR- DTB125-6A&6B)
1T66E-11.8 W01-358-8984			<p>Order No. N/A</p>	25.8	Wabash (Roadrailer Rowe Truck AS- C1400HL Ride

Hardware Key





- Bolt or Stud 1/2-13
- ⊙ Threaded Hole 3/8-16 Blind Nut on Bead Plates 1/2-13 Pistons
- ⊗ Air Inlet 1/4 N.P.T.
- ⊕ No Alignment Specified-Center Stud Mounting is Standard
- ⊗ Combination Stud/Air Inlet Stud Outside Thread is 3/4-16
- ⊕ Studs Inside Thread (Air Inlet) is 1/4 N.P.T. Exceptions Will Be Noted on Part View as ⊗

1T - Reversible Sleeve

BELLOW NO. ASSEMBLY ORDER NO.	CROSS SECTION VIEW	BEAD PLATE TOP VIEW	PISTON BOTTOM VIEW	ASSEMBLY WEIGHT (lbs.)	REPLACES

1T Style Springs

Hardware Key

 Bolt or Stud 1/2-13
  Threaded Hole 3/8-16 Blind Nut on Bead Plates 1/2-13 Pistons
  Air Inlet 1/4 N.P.T.
 No Alignment Specified-Center Stud Mounting is Standard
 Combination Stud/Air Inlet Stud Outside Thread is 3/4-16
 Studs Inside Thread (Air Inlet) is 1/4 N.P.T. Exceptions Will Be Noted on Part View as 

Reading the parts table for convoluted style springs

1	2	3	4	5	6
BELLOW NO. ASSEMBLY ORDER NO.	CROSS SECTION VIEW	BEAD PLATE TOP VIEW	PISTON BOTTOM VIEW	ASSEMBLY WEIGHT (lbs.)	REPLACES
25 W01-358-7025				N/A	Western Star (cab spring)

Hardware Key

- Bolt or Stud 1/2-13 ● Threaded Hole 3/8-16 Blind Nut on Bead Plates 1/2-13 Pistons ⊗ Air Inlet 1/4 N.P.T. No Alignment Specified-Center Stud Mounting is Standard
- ⊗ Combination Stud/Air Inlet Stud Outside Thread is 3/4-16 Studs Inside Thread (Air Inlet) is 1/4 N.P.T. Exceptions Will Be Noted on Part View as ⊗

1. Bellow No. and Assembly Order Number (AON)

This number identifies the specific bellows number and the assembly order number for ordering purposes. (i.e. - Complete Order No. for any type of electronic ordering - EDI - is W01-358-7025).

2. Airide Cross Section View

A cross sectional view of the Airide spring showing dimensional information in inches on **uninflated** diameter and minimum height. A bumper drawing is also referenced if applicable.

3. Bead Plate-Top View

A top view of the upper bead plate with dimensional information and detail on mounting attachments (see hardware key). An Internal Firestone reference Number is also shown (i.e.-3030).

4. Bead Plate-Bottom View

A bottom view of the lower bead plate with dimensional information and detail on mounting attachments (see hardware key). An Internal Firestone reference Number is also shown (i.e.-3025).

5. Assembly Weight

Gives total weight of the assembly in pounds.

6. Replaces

Vehicle and suspension manufacturers' part numbers for the particular Airide spring.



Convolutional Style

Double Convolutional



Triple Convolutional



Single Convolutional



Firestone convolutional Airide springs are available in three styles—single, double, or triple convolutional—as shown above.

To identify the exact style and part number to replace your current air spring, you need to identify the type of bellows, bead plates, and attaching hardware used, as well as determining whether the spring has an internal bumper.

First, look for the manufacturer's part number and Firestone order number stamped in ink on the bead plate. If illegible, read the part number molded on the bellows, normally under the Firestone name. If the number (20, 22, etc.) is present, simply refer to the proper section of this guide.

If for any reason the number is unreadable, you can determine the bellows type with two simple measurements. Remove the air entrance and allow the bellows to assume its normal shape. Then, measure the bead plate diameter

and the outer diameter of the bellows, as shown below. Compare these diameters with those listed in the bellows index for the specific type of convolutional (single, double or triple) bellows that you have.

To determine the presence of an internal bumper in the spring, remove the air and collapse the spring to its minimum height. Then, measure this height, as shown below, and compare that measurement with those listed in the proper section of this guide.

Finally, to complete the parts identification, compare the metal bead plates and attaching hardware with the assemblies detailed in that same section of the guide.

For your convenience, typical types of attaching hardware are illustrated below.

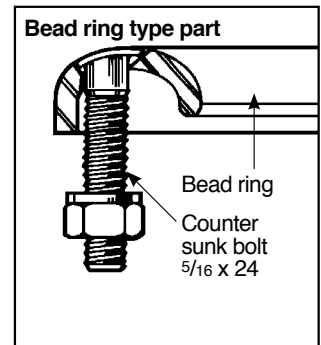
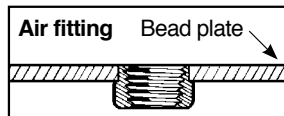
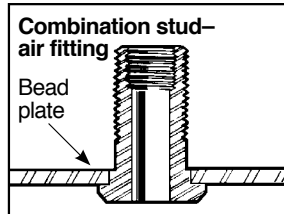
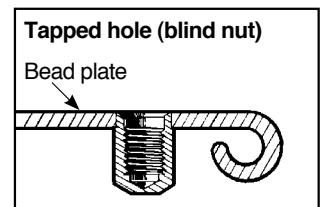
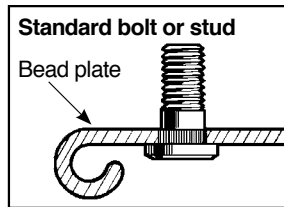
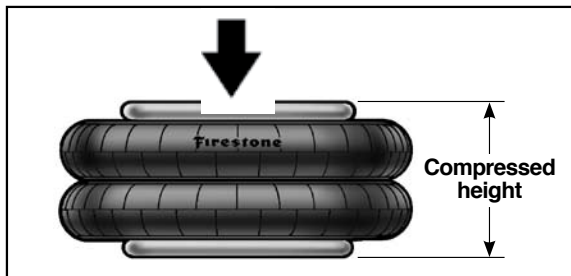
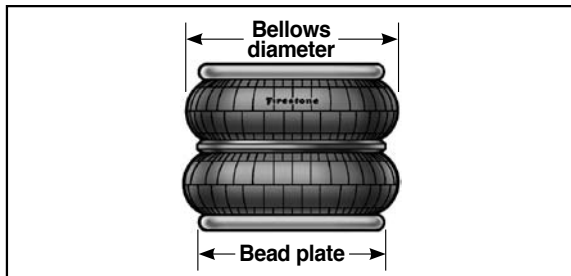

Firestone

BELLOW NO. ASSEMBLY ORDER NO.	CROSS SECTION VIEW	BEAD PLATE TOP VIEW	BEAD PLATE BOTTOM VIEW	ASSEMBLY WEIGHT (lbs.)	REPLACES
113-1X88-1				N/A	Granning 1080
W01-358-7113					
19				11.2	Capacity of Texas
W01-358-6994					
19				N/A	Holland (Neway) 90557226
W01-358-7008					
19				11.4	Holland (Neway) 90557002
W01-358-7009					
19.75				11.8	Chalmers
W01-358-7043					

Hardware Key

- Bolt or Stud 1/2-13
- ⊙ Threaded Hole 3/8-16 Blind Nut on Bead Plates 1/2-13 Pistons
- ⊗ Air Inlet 1/4 N.P.T.
- ▲ No Alignment Specified-Center Stud Mounting is Standard
- ⊗ Combination Stud/Air Inlet Stud Outside Thread is 3/4-16
- ⊗ Studs Inside Thread (Air Inlet) is 1/4 N.P.T. Exceptions Will Be Noted on Part View as ⊗

Convolved Style Parts

BELLOW NO. ASSEMBLY ORDER NO.	CROSS SECTION VIEW	BEAD PLATE TOP VIEW	BEAD PLATE BOTTOM VIEW	ASSEMBLY WEIGHT (lbs.)	REPLACES
113 W01-358-7103				14.2	Peerless 0550-00015
113 W01-358-7104				16.0	Miscellaneous
113-.5 W01-358-7093				17.1	American Carrier 8003-013
113 W01-358-7105				16.1	American Carrier 8003-007
113-1 W01-358-7088				N/A	Suspensions Inc. 200175

Convolved Style Springs

Hardware Key

- Bolt or Stud 1/2-13
- ⊗ Threaded Hole 3/8-16 Blind Nut on Bead Plates 1/2-13 Pistons
- ⊗ Air Inlet 1/4 N.P.T.
- ▲ No Alignment Specified-Center Stud Mounting is Standard
- ⊗ Combination Stud/Air Inlet Stud Outside Thread is 3/4-16
- Studs Inside Thread (Air Inlet) is 1/4 N.P.T. Exceptions Will Be Noted on Part View as ⊗

Firestone

BELLOW NO. ASSEMBLY ORDER NO.	CROSS SECTION VIEW	BEAD PLATE TOP VIEW	BEAD PLATE BOTTOM VIEW	ASSEMBLY WEIGHT (lbs.)	REPLACES
113-1 W01-358-7094				16.4	Chalmers
113-1 W01-358-7096				N/A	Suspensions Inc. 200792
113-1 W01-358-7112				15.2	Holland (Neway) 90557028 Ridewell 1003587112C
113-1 W01-358-7117				17.1	American Carrier
126 W01-358-7726				44.5	Air Suspended Fifth Wheel Tartan Transportation (Classic Ride)/Air- glide

Hardware Key

- Bolt or Stud 1/2-13
- ⊙ Threaded Hole 3/8-16 Blind Nut on Bead Plates 1/2-13 Pistons
- ⊗ Air Inlet 1/4 N.P.T.
- ▲ No Alignment Specified-Center Stud Mounting is Standard
- ⊗ Combination Stud/Air Inlet Stud Outside Thread is 3/4-16
- ⊗ Studs Inside Thread (Air Inlet) is 1/4 N.P.T. Exceptions Will Be Noted on Part View as ⊗

Convuluted Style Parts

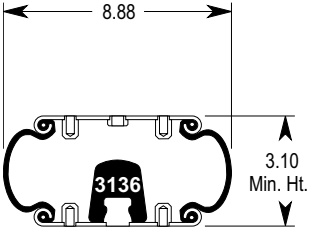
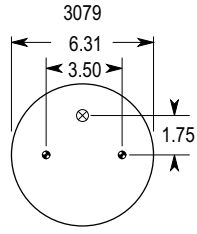
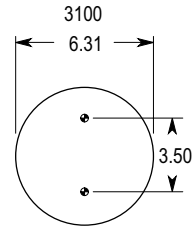
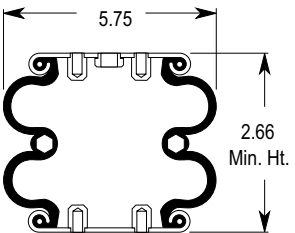
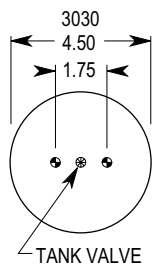
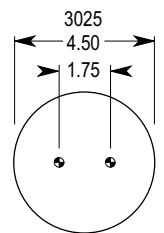
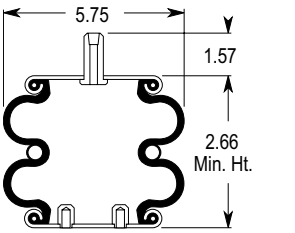
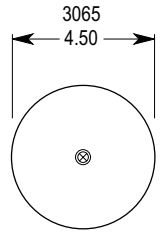
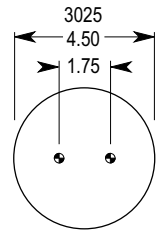
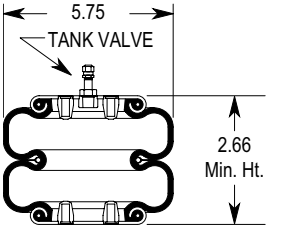
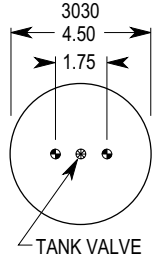
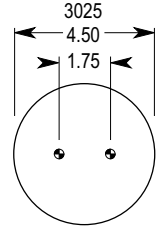
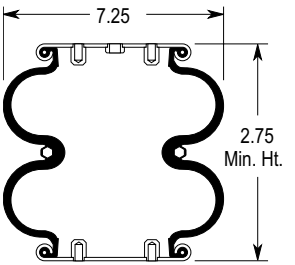
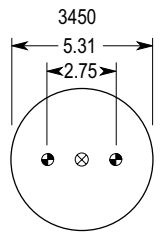
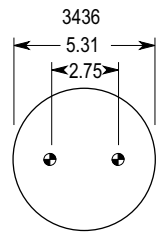
BELLOW NO. ASSEMBLY ORDER NO.	CROSS SECTION VIEW	BEAD PLATE TOP VIEW	BEAD PLATE BOTTOM VIEW	ASSEMBLY WEIGHT (lbs.)	REPLACES
150 W01-358-7462				N/A	Load Share
25 W01-358-7025				N/A	Western Star (cab spring)
25 W01-358-7057				6.7	Sauer P10-794
255-1.5 W01-358-6831				N/A	John Deere AW30683
224 W01-358-3400				4.6	American Carrier 8003-009

Convuluted Style Springs

Hardware Key

- Bolt or Stud 1/2-13
- ⊗ Threaded Hole 3/8-16 Blind Nut on Bead Plates 1/2-13 Pistons
- ⊗ Air Inlet 1/4 N.P.T.
- ▲ No Alignment Specified-Center Stud Mounting is Standard
- ⊗ Combination Stud/Air Inlet Stud Outside Thread is 3/4-16
- ⊗ Studs Inside Thread (Air Inlet) is 1/4 N.P.T. Exceptions Will Be Noted on Part View as ⊗

Firestone

BELLOW NO. ASSEMBLY ORDER NO.	CROSS SECTION VIEW	BEAD PLATE TOP VIEW	BEAD PLATE BOTTOM VIEW	ASSEMBLY WEIGHT (lbs.)	REPLACES
224 W01-358-3402				4.9	American Carrier 8003-026 (supercedes 9455-Bellows 1T47A-1) (replaces W01-358-3401 and W01-358-3405)
224 W01-358-3406				4.9	Sauer P20-706
264 W01-358-3420				N/A	Hendrickson Aux. 004647
26 W01-358-7279				7.2	Hendrickson 45843-2
26 W01-358-7325				5.6	American Carrier 8003-006 Mack 227QS-32 & 57QK1113 Sauer P10-754 Texas Truck Watson & Chalin AS-0030

Hardware Key

- Bolt or Stud 1/2-13
- ⊙ Threaded Hole 3/8-16 Blind Nut on Bead Plates 1/2-13 Pistons
- ⊗ Air Inlet 1/4 N.P.T.
- ▲ No Alignment Specified-Center Stud Mounting is Standard
- ⊗ Combination Stud/Air Inlet Stud Outside Thread is 3/4-16
- ⊗ Studs Inside Thread (Air Inlet) is 1/4 N.P.T. Exceptions Will Be Noted on Part View as ⊗

Convuluted Style Parts

BELLOW NO. ASSEMBLY ORDER NO.	CROSS SECTION VIEW	BEAD PLATE TOP VIEW	BEAD PLATE BOTTOM VIEW	ASSEMBLY WEIGHT (lbs.)	REPLACES
26 W01-358-7330				N/A	Ridwell 1003587330
26 W01-358-7505				N/A	Hendrickson 001347
26 W01-358-7705				N/A	Watson Chalin AS-006 (Replaces 7503)
20 W01-358-6890				N/A	Holland (Neway) 90557228 V-Steer 1 (Lift Bag)
20 W01-358-6900				N/A	Ridwell

Convuluted Style Springs

Hardware Key

- Bolt or Stud 1/2-13
- ⊗ Threaded Hole 3/8-16 Blind Nut on Bead Plates 1/2-13 Pistons
- ⊗ Air Inlet 1/4 N.P.T.
- ▲ No Alignment Specified-Center Stud Mounting is Standard
- ⊗ Combination Stud/Air Inlet Stud Outside Thread is 3/4-16
- Studs Inside Thread (Air Inlet) is 1/4 N.P.T. Exceptions Will Be Noted on Part View as ⊗

Firestone

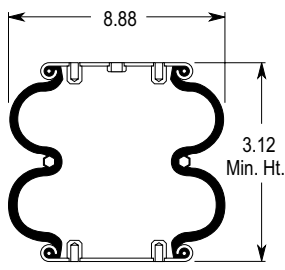
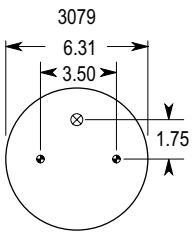
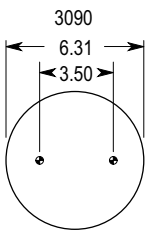
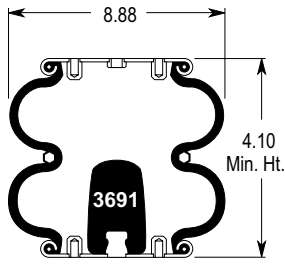
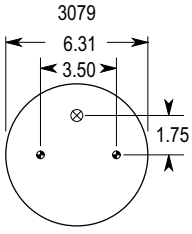
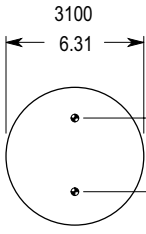
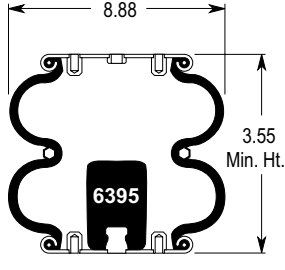
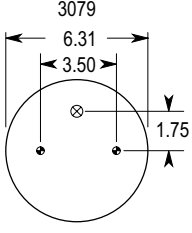
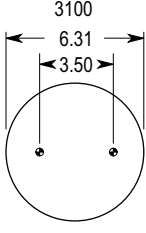
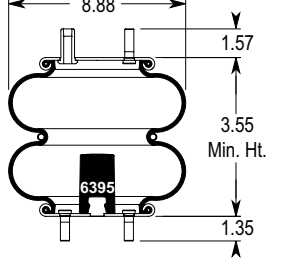
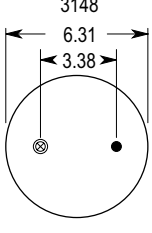
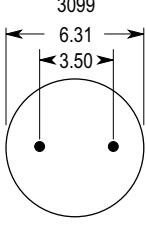
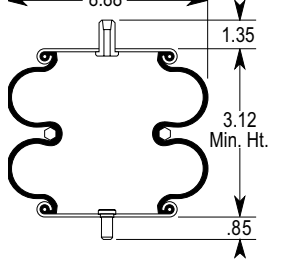
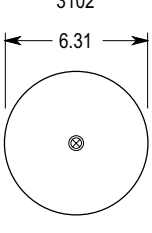
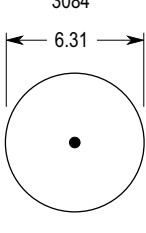
BELLOW NO. ASSEMBLY ORDER NO.	CROSS SECTION VIEW	BEAD PLATE TOP VIEW	BEAD PLATE BOTTOM VIEW	ASSEMBLY WEIGHT (lbs.)	REPLACES
20 W01-358-6910				7.2	Granning 1371 Hendrickson Trailer S8768 Hendrickson Can. 45843-3 Ridewell 1003586910C Watson & Chalin AS-0001
20 W01-358-6926				N/A	Load Share
20 W01-358-6856				N/A	Tuthill Granning 702932-01
20 W01-358-6884					Link 1103-0019
20 W01-358-6897					Watson & Chalin AS-0058

Hardware Key

- Bolt or Stud 1/2-13
- ⊙ Threaded Hole 3/8-16 Blind Nut on Bead Plates 1/2-13 Pistons
- ⊗ Air Inlet 1/4 N.P.T.
- ▲ No Alignment Specified-Center Stud Mounting is Standard
- ⊗ Combination Stud/Air Inlet Stud Outside Thread is 3/4-16
- ⊗ Studs Inside Thread (Air Inlet) is 1/4 N.P.T. Exceptions Will Be Noted on Part View as ⊗

Convoluted Style Parts

BELLOW NO. ASSEMBLY ORDER NO.	CROSS SECTION VIEW	BEAD PLATE TOP VIEW	BEAD PLATE BOTTOM VIEW	ASSEMBLY WEIGHT (lbs.)	REPLACES
20 W01-358-6902				7.8	Granning 4848 Hendrickson Trailer S2630 R & S Truck & Body 1027505 Ridewell 1003586902C American Carrier Suspensions Inc. 2000-42 Watson & Chalin AS-0002
20 W01-358-6905				7.9	Hendrickson Trailer S3518 Hendrickson Trailer S5270 Hendrickson Can. 45843-1 Ridewell 1003586905C Silent Drive EZ Ride 8030120 Monaco Coach Watson & Chalin AS-0020
20 W01-358-6908				7.5	Watson & Chalin AS-0035
20 W01-358-6932				9.3	Ridewell 1003586932C
20 W01-358-6935					Hendrickson Trailer S14318 HLM Lift Bag Hendrickson Aux. 003318 (metric version)

Convolute Style Springs

Hardware Key

- Bolt or Stud 1/2-13
- ⊗ Threaded Hole 3/8-16 Blind Nut on Bead Plates 1/2-13 Pistons
- ⊗ Air Inlet 1/4 N.P.T.
- ▲ No Alignment Specified-Center Stud Mounting is Standard
- ⊗ Combination Stud/Air Inlet Stud Outside Thread is 3/4-16
- Studs Inside Thread (Air Inlet) is 1/4 N.P.T. Exceptions Will Be Noted on Part View as ⊗

Firestone

BELLOW NO. ASSEMBLY ORDER NO.	CROSS SECTION VIEW	BEAD PLATE TOP VIEW	BEAD PLATE BOTTOM VIEW	ASSEMBLY WEIGHT (lbs.)	REPLACES
20 W01-358-6940				7.9	Histeer 10305
20 W01-358-6941				7.8	Histeer 10302
20 W01-358-6949					Load Air P-10872-A
20 W01-358-7686					Rowe Truck 0035 ASC2500 ASC1600
20 W01-358-7788					Watson & Chalin AS-0088

Hardware Key

- Bolt or Stud 1/2-13
- ⊙ Threaded Hole 3/8-16 Blind Nut on Bead Plates 1/2-13 Pistons
- ⊗ Air Inlet 1/4 N.P.T.
- ▲ No Alignment Specified-Center Stud Mounting is Standard
- ⊗ Combination Stud/Air Inlet Stud Outside Thread is 3/4-16
- ⊗ Studs Inside Thread (Air Inlet) is 1/4 N.P.T. Exceptions Will Be Noted on Part View as ⊗

Convolved Style Parts

BELLOW NO. ASSEMBLY ORDER NO.	CROSS SECTION VIEW	BEAD PLATE TOP VIEW	BEAD PLATE BOTTOM VIEW	ASSEMBLY WEIGHT (lbs.)	REPLACES
20 W01-358-7795					Hendrickson Trailer S14486 (lift bag) Hendrickson Aux. (Paralift, Paralift Ultra) Hendrickson Aux. 003317 (metric version)
20 W01-358-7892					Ridewell 1003587893C
20-1 W01-358-6883					Watson & Chalin AS-0092
20-1 W01-358-6886					Watson & Chalin AS-0058-1F Tuthill-Reyco 701784-01
20-1 W01-358-7897					Hendrickson Aux. 002878 (Lift Bag) Hendrickson Aux. (Pararev) Hendrickson Trailer S23114

Convolved Style Springs

Hardware Key

- Bolt or Stud 1/2-13
- ⊗ Threaded Hole 3/8-16 Blind Nut on Bead Plates 1/2-13 Pistons
- ⊗ Air Inlet 1/4 N.P.T.
- ▲ No Alignment Specified-Center Stud Mounting is Standard
- ⊗ Combination Stud/Air Inlet Stud Outside Thread is 3/4-16
- Studs Inside Thread (Air Inlet) is 1/4 N.P.T. Exceptions Will Be Noted on Part View as ⊗

Firestone

BELLOW NO. ASSEMBLY ORDER NO.	CROSS SECTION VIEW	BEAD PLATE TOP VIEW	BEAD PLATE BOTTOM VIEW	ASSEMBLY WEIGHT (lbs.)	REPLACES
20-2 W01-358-5900					Link 1103-0059
20-2 W01-358-6392					Arvin Meritor 2258-G-1489
20-2 W01-358-6817					Ridewell 1003586817C
20-2 W01-358-6927				7.3	Reyco 12906-01
20-2 W01-358-6943				8.1	Watson & Chalin AS-0041 Van Raden Holland (Neway) 90557237 V-Steer II (Lift Bag)

Hardware Key

- Bolt or Stud 1/2-13
- ⊙ Threaded Hole 3/8-16 Blind Nut on Bead Plates 1/2-13 Pistons
- ⊗ Air Inlet 1/4 N.P.T.
- ▲ No Alignment Specified-Center Stud Mounting is Standard
- ⊗ Combination Stud/Air Inlet Stud Outside Thread is 3/4-16
- ⊗ Studs Inside Thread (Air Inlet) is 1/4 N.P.T. Exceptions Will Be Noted on Part View as ⊗

Convoluted Style Parts

BELLOW NO. ASSEMBLY ORDER NO.	CROSS SECTION VIEW	BEAD PLATE TOP VIEW	BEAD PLATE BOTTOM VIEW	ASSEMBLY WEIGHT (lbs.)	REPLACES
20-2 W01-358-6944				8.4	Histeer 10307 Suspensions Inc.
20-2 W01-358-6945				8.6	Ridewell 1003586945C
20-2 W01-358-6946				8.5	Ridewell 1003586946C
20-2 W01-358-6947				8.4	Hendrickson Trailer S8701 Ridewell 1003586947C
20-2 W01-358-6948				8.6	Ridewell 1003586948C Silent Drive

Convolute Style Springs

Hardware Key

- Bolt or Stud 1/2-13
- ⊗ Threaded Hole 3/8-16 Blind Nut on Bead Plates 1/2-13 Pistons
- ⊗ Air Inlet 1/4 N.P.T.
- ▲ No Alignment Specified-Center Stud Mounting is Standard
- ⊗ Combination Stud/Air Inlet Stud Outside Thread is 3/4-16
- ⊗ Studs Inside Thread (Air Inlet) is 1/4 N.P.T. Exceptions Will Be Noted on Part View as ⊗

Firestone

BELLOW NO. ASSEMBLY ORDER NO.	CROSS SECTION VIEW	BEAD PLATE TOP VIEW	BEAD PLATE BOTTOM VIEW	ASSEMBLY WEIGHT (lbs.)	REPLACES
20-2 W01-358-6960				N/A	Granning 7025
20-2 W01-358-6962					Hendrickson Trailer S21323
22 W01-358-7180				12.2	EZ Ride 8030190 Hendrickson Kwiklok/Todco (Jif-flox) Peerless 0550-00001 Talbert Ridewell 1003587180C
22 W01-358-7181				12.8	Fruehauf UAB-5620 Fruehauf UCC-3054-1
22 W01-358-7183				14.5	Fruehauf UCA-0112 Fruehauf UCA-0112-B

Hardware Key

- Bolt or Stud 1/2-13
- ⊙ Threaded Hole 3/8-16 Blind Nut on Bead Plates 1/2-13 Pistons
- ⊗ Air Inlet 1/4 N.P.T.
- ▲ No Alignment Specified-Center Stud Mounting is Standard
- ⊗ Combination Stud/Air Inlet Stud Outside Thread is 3/4-16
- ⊗ Studs Inside Thread (Air Inlet) is 1/4 N.P.T. Exceptions Will Be Noted on Part View as ⊗

Convolved Style Parts

BELLOW NO. ASSEMBLY ORDER NO.	CROSS SECTION VIEW	BEAD PLATE TOP VIEW	BEAD PLATE BOTTOM VIEW	ASSEMBLY WEIGHT (lbs.)	REPLACES
22 W01-358-7185				14.0	Chalmers
22 W01-358-7344				N/A	Load Air P10-755C Sauer P10-755C
22 W01-358-7400				14.1	Fab Tek 04-0080 Freightliner 16-10769-000 GMC 693230 Granning 2726 Hendrickson Trailer S1013 Holland (Neway) 90557016 R & S Truck & Body 1027519 Ridewell 1003587400C
22 W01-358-7401				17.6	GMC 711954 GMC 2076095 Volvo/GM Heavy Duty Truck 2076095 Watson & Chalin AS-0014
22 W01-358-7403				14.0	Granning 2725 Hendrickson Trailer S1159 Hendrickson Trailer S2883 Hendrickson Can. B-12514-001 R & S Truck & Body 1040201 Ridewell 1003587403C Watson & Chalin AS-0007

Convolved Style Springs

Hardware Key

- Bolt or Stud 1/2-13
- ⊗ Threaded Hole 3/8-16 Blind Nut on Bead Plates 1/2-13 Pistons
- ⊗ Air Inlet 1/4 N.P.T.
- ▲ No Alignment Specified-Center Stud Mounting is Standard
- ⊗ Combination Stud/Air Inlet Stud Outside Thread is 3/4-16
- ▲ Studs Inside Thread (Air Inlet) is 1/4 N.P.T. Exceptions Will Be Noted on Part View as ⊗

Firestone

BELLOW NO. ASSEMBLY ORDER NO.	CROSS SECTION VIEW	BEAD PLATE TOP VIEW	BEAD PLATE BOTTOM VIEW	ASSEMBLY WEIGHT (lbs.)	REPLACES
22 W01-358-7404				12.2	Hendrickson Trailer S5468 Hendrickson Can. S1345 (replaced by 7472)
22 W01-358-7405				14.5	Hutchens H-10384-01 Suspensions Inc.
22 W01-358-7406				13.8	Ridewell 1003587406C
22 W01-358-7408				13.8	EZ Ride
22 W01-358-7409				14.2	Fruehauf

Hardware Key

- Bolt or Stud 1/2-13
- ⊙ Threaded Hole 3/8-16 Blind Nut on Bead Plates 1/2-13 Pistons
- ⊗ Air Inlet 1/4 N.P.T.
- ▲ No Alignment Specified-Center Stud Mounting is Standard
- ⊗ Combination Stud/Air Inlet Stud Outside Thread is 3/4-16
- ⊗ Studs Inside Thread (Air Inlet) is 1/4 N.P.T. Exceptions Will Be Noted on Part View as ⊗

Convolved Style Parts

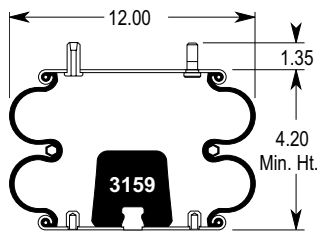
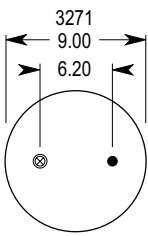
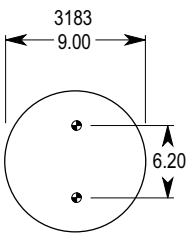
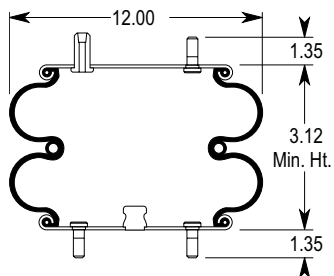
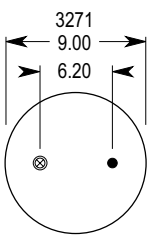
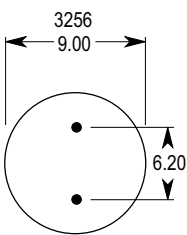
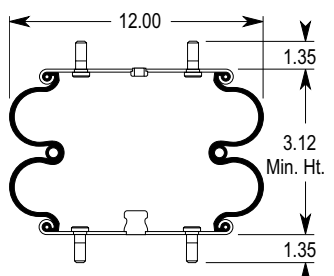
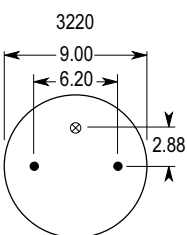
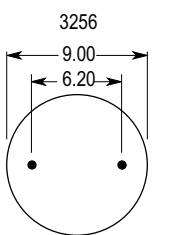
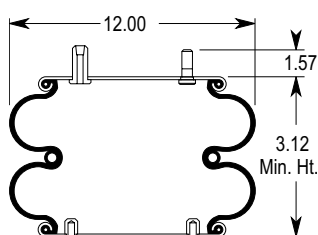
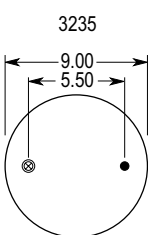
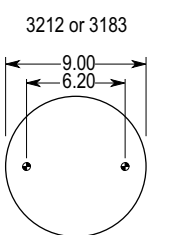
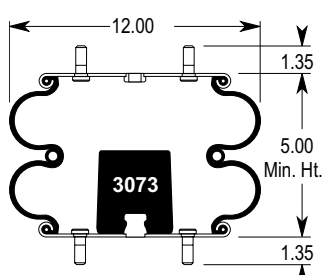
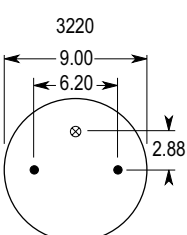
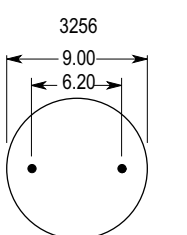
BELLOW NO. ASSEMBLY ORDER NO.	CROSS SECTION VIEW	BEAD PLATE TOP VIEW	BEAD PLATE BOTTOM VIEW	ASSEMBLY WEIGHT (lbs.)	REPLACES
22 W01-358-7410				14.6	Freightliner 16-11378-000
22 W01-358-7423				12.7	Sauer P10-784
22 W01-358-7424				12.6	Intergrated Holland (Neway) 90557014 (AL-41 & 45) Porcupine R & S Truck & Body 1090215 Sauer P10-755
22 W01-358-7429				12.4	Kwik Lok/Todco (Jif-flox) CP-5223 Silent Drive
22 W01-358-7437				14.6	Holland (Neway) 90557015 Ridewell 1003587437C

Convolved Style Springs

Hardware Key

- Bolt or Stud 1/2-13
- ⊗ Threaded Hole 3/8-16 Blind Nut on Bead Plates 1/2-13 Pistons
- ⊗ Air Inlet 1/4 N.P.T.
- ▲ No Alignment Specified-Center Stud Mounting is Standard
- ⊗ Combination Stud/Air Inlet Stud Outside Thread is 3/4-16
- Studs Inside Thread (Air Inlet) is 1/4 N.P.T. Exceptions Will Be Noted on Part View as ⊗

Firestone

BELLOW NO. ASSEMBLY ORDER NO.	CROSS SECTION VIEW	BEAD PLATE TOP VIEW	BEAD PLATE BOTTOM VIEW	ASSEMBLY WEIGHT (lbs.)	REPLACES
22-1.5 W01-358-6789				N/A	Hendrickson Aux. 001503
22-1.5 W01-358-7443				12.7	Granning 1218 (replaces 7416) Watson & Chalin AS-0027 (replaces 7416) Ridewell 1003587443C
22-1.5 W01-358-7444				12.7	Hendrickson Trailer S9830
22-1.5 W01-358-7446				14.7	Hendrickson Trailer S3798 R & S Truck & Body 1082914 Watson & Chalin AS-0005
22-1.5 W01-358-7447				14.3	EZ Ride 8030150 Hendrickson Trailer S6242 Silent Drive

Hardware Key

- Bolt or Stud 1/2-13
- ⊙ Threaded Hole 3/8-16 Blind Nut on Bead Plates 1/2-13 Pistons
- ⊗ Air Inlet 1/4 N.P.T.
- ▲ No Alignment Specified-Center Stud Mounting is Standard
- ⊗ Combination Stud/Air Inlet Stud Outside Thread is 3/4-16
- ⊗ Studs Inside Thread (Air Inlet) is 1/4 N.P.T. Exceptions Will Be Noted on Part View as ⊗

Convuluted Style Parts

BELLOW NO. ASSEMBLY ORDER NO.	CROSS SECTION VIEW	BEAD PLATE TOP VIEW	BEAD PLATE BOTTOM VIEW	ASSEMBLY WEIGHT (lbs.)	REPLACES
22-1.5 W01-358-7473				14.3	Ridewell 1003587473C
22-1.5 W01-358-7483				13.2	Ridewell 1003587483C
22-1.5 W01-358-7499					Suspensions Inc.
22-1.5 W01-358-7790					Hendrickson Aux. 001475
22-1.5 W01-358-7472				12.6	Hendrickson Can. B-12514-005

Convuluted Style Springs

Hardware Key

- Bolt or Stud 1/2-13
- ⊗ Threaded Hole 3/8-16 Blind Nut on Bead Plates 1/2-13 Pistons
- ⊗ Air Inlet 1/4 N.P.T.
- ▲ No Alignment Specified-Center Stud Mounting is Standard
- ⊗ Combination Stud/Air Inlet Stud Outside Thread is 3/4-16
- Studs Inside Thread (Air Inlet) is 1/4 N.P.T. Exceptions Will Be Noted on Part View as ⊗

Firestone

BELLOW NO. ASSEMBLY ORDER NO.	CROSS SECTION VIEW	BEAD PLATE TOP VIEW	BEAD PLATE BOTTOM VIEW	ASSEMBLY WEIGHT (lbs.)	REPLACES
228CT-1.5 W01-358-7545					Hendrickson Aux. 001796 (Paralift Ultra/High Lift) -lift bag Watson & Chalin AS-0087-1F
228-1.5 W01-358-7550				13.4	Watson & Chalin AS-0087 Histeer 10315
228-1.5 W01-358-7555				13.4	Reyco 20018-01 (86AR) Binkley XB-SPN-053-37 (Note: supersedes W01-358-7550)
252 W01-358-8235					Caterpillar
21 W01-358-7123				22.2	Kwik Lok/Todco (Jifflox) 53671 (supersedes 7133)

Hardware Key

- Bolt or Stud 1/2-13
- ◐ Threaded Hole 3/8-16 Blind Nut on Bead Plates 1/2-13 Pistons
- ⊗ Air Inlet 1/4 N.P.T.
- ▲ No Alignment Specified-Center Stud Mounting is Standard
- ⊗ Combination Stud/Air Inlet Stud Outside Thread is 3/4-16
- ⊗ Studs Inside Thread (Air Inlet) is 1/4 N.P.T. Exceptions Will Be Noted on Part View as ⊗

Convolved Style Parts

BELLOW NO. ASSEMBLY ORDER NO.	CROSS SECTION VIEW	BEAD PLATE TOP VIEW	BEAD PLATE BOTTOM VIEW	ASSEMBLY WEIGHT (lbs.)	REPLACES
21 W01-358-7135		3123 or 3132 	3122 	17.8	Holland (Neway) 90557001 Pezzani AR-21-A Ridewell 1003587135C Silent Drive Truckstell (Marion Mfg.) 63641 Truckstell (Marion Mfg.) 63644 Hendrickson Can. B-12514-014
21 W01-358-7136		3134 	3130 	19.8	Fargo Trailer Granning 1626 Hendrickson Trailer S1080 R & S Truck & Body 1027556 Ridewell 1003587136C Watson & Chalin AS-0004
21 W01-358-7140		3132 	3122 	20.6	Granning 1015 Hendrickson Trailer S3184 Porcupine (replaces 7142) R & S Truck & Body 1090214 Ridewell 1003587140C Temisko Watson & Chalin AS-0008
21 W01-358-7145		3131 or 3134 	3130 	16.8	Mack 57QL239 Ridewell 1003587145C Volvo/GM-Heavy Duty Truck 35203-0005
21 W01-358-7146		3134 	3130 	20.0	American Carrier 8003-005 EZ Ride Holland (Neway) 90557039 Ridewell 1003587146C Willmar Gallenberg Mod. Flow Equip.

Convolved Style Springs

Hardware Key

- Bolt or Stud 1/2-13
- ⊗ Threaded Hole 3/8-16 Blind Nut on Bead Plates 1/2-13 Pistons
- ⊗ Air Inlet 1/4 N.P.T.
- ▲ No Alignment Specified-Center Stud Mounting is Standard
- ⊗ Combination Stud/Air Inlet Stud Outside Thread is 3/4-16
- ⊗ Studs Inside Thread (Air Inlet) is 1/4 N.P.T. Exceptions Will Be Noted on Part View as ⊗

Firestone

BELLOW NO. ASSEMBLY ORDER NO.	CROSS SECTION VIEW	BEAD PLATE TOP VIEW	BEAD PLATE BOTTOM VIEW	ASSEMBLY WEIGHT (lbs.)	REPLACES
21 W01-358-8171					Arvin Meritor A-2258-A-1457 RPH-11
205 W01-358-7118				20.4	Granning 2279
205 W01-358-7927					Maurice Welding
21-2 W01-358-6801				21.1	EZ Ride 8030160 Hendrickson Trailer S2734 Ridewell 1003586801C Watson & Chalin AS-0021
21-2 W01-358-6800					Watson & Chalin AS-0034 (see W01-358-6808)

Hardware Key

- Bolt or Stud 1/2-13
- ⊙ Threaded Hole 3/8-16 Blind Nut on Bead Plates 1/2-13 Pistons
- ⊗ Air Inlet 1/4 N.P.T.
- ▲ No Alignment Specified-Center Stud Mounting is Standard
- ⊗ Combination Stud/Air Inlet Stud Outside Thread is 3/4-16
- ⊗ Studs Inside Thread (Air Inlet) is 1/4 N.P.T. Exceptions Will Be Noted on Part View as ⊗

Convuluted Style Parts

BELLOW NO. ASSEMBLY ORDER NO.	CROSS SECTION VIEW	BEAD PLATE TOP VIEW	BEAD PLATE BOTTOM VIEW	ASSEMBLY WEIGHT (lbs.)	REPLACES
21-2 W01-358-6803					Hendrickson Trailer S6412
21-2 W01-358-6805					Ridewell 1003586805C
21-2 W01-358-6808					Watson & Chalin AS-0034 Holland (Neway) (replaced by 6799)
233-2 W01-358-6799					Holland (Neway) 90557203
233-2 W01-358-7557					Reyco 19983-01 (21AR, 74AR) Watson & Chalin AS-0089 Histeer 10316

Convuluted Style Springs

Hardware Key

- Bolt or Stud 1/2-13
- ⊗ Threaded Hole 3/8-16 Blind Nut on Bead Plates 1/2-13 Pistons
- ⊗ Air Inlet 1/4 N.P.T.
- ▲ No Alignment Specified-Center Stud Mounting is Standard
- ⊗ Combination Stud/Air Inlet Stud Outside Thread is 3/4-16
- ⊗ Studs Inside Thread (Air Inlet) is 1/4 N.P.T. Exceptions Will Be Noted on Part View as ⊗

Firestone

BELLOW NO. ASSEMBLY ORDER NO.	CROSS SECTION VIEW	BEAD PLATE TOP VIEW	BEAD PLATE BOTTOM VIEW	ASSEMBLY WEIGHT (lbs.)	REPLACES
233-2 W01-358-7781				22.7	Ridewell 1003587781C
233-2 W01-358-7782				23.3	Porcupine (replaces 7140) Watson & Chalin AS-0032 (replaces 7240)
256-2 W01-358-7792					Watson & Chalin AS-0064
256-2 W01-358-7794					Suspensions Inc.
28 W01-358-7512					Wilmar Gallenberg

Hardware Key

- Bolt or Stud 1/2-13
- ⊙ Threaded Hole 3/8-16 Blind Nut on Bead Plates 1/2-13 Pistons
- ⊗ Air Inlet 1/4 N.P.T.
- ▲ No Alignment Specified-Center Stud Mounting is Standard
- ⊗ Combination Stud/Air Inlet Stud Outside Thread is 3/4-16
- ⊗ Studs Inside Thread (Air Inlet) is 1/4 N.P.T. Exceptions Will Be Noted on Part View as ⊗

Convoluted Style Parts

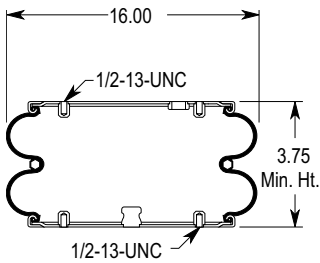
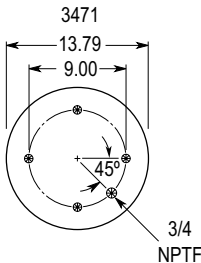
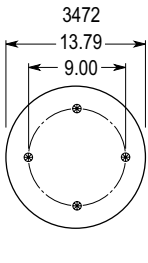
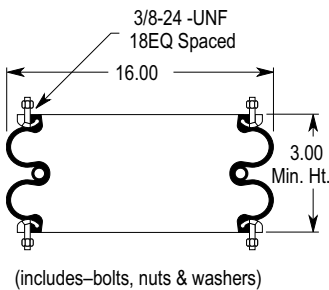
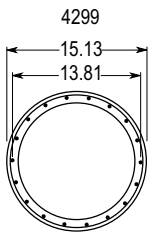
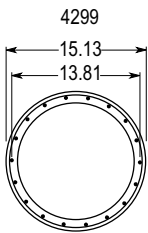
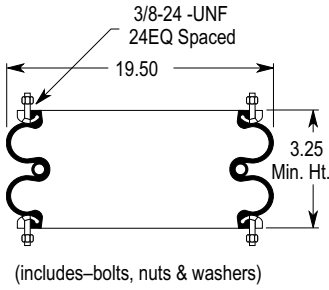
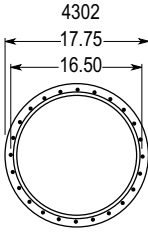
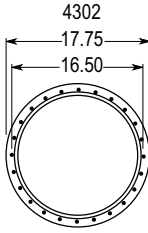
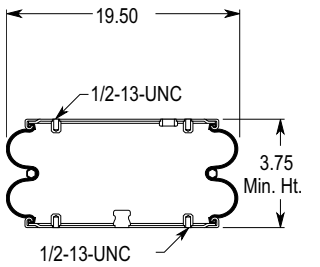
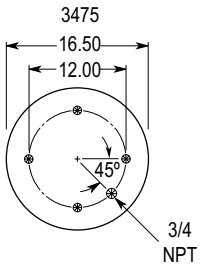
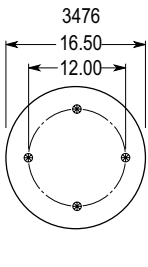
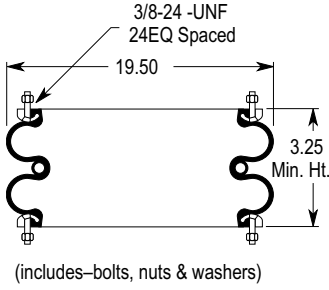
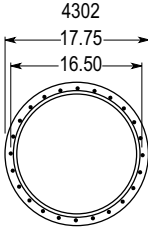
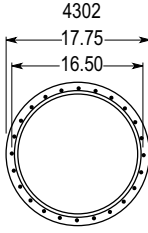
BELLOW NO. ASSEMBLY ORDER NO.	CROSS SECTION VIEW	BEAD PLATE TOP VIEW	BEAD PLATE BOTTOM VIEW	ASSEMBLY WEIGHT (lbs.)	REPLACES
28 W01-358-7271				18.1	Ridewell 1003587271C
201 W01-358-7244	 (includes-bolts, nuts & washers)			18.7	Unit Rig 1001404 Dart 21-40057
203 W01-358-7226	 (includes-bolts, nuts & washers)			24.8	Rimpull
203 W01-358-7273				42.6	Ridewell 1003587273C Watson & Chalin AS-0045
218 W01-358-7294	 (includes-bolts, nuts & washers)			25.4	Unit Rig 1016031 Dart 21-40061

Convolute Style Springs

Hardware Key

- Bolt or Stud 1/2-13
- ⊖ Threaded Hole 3/8-16 Blind Nut on Bead Plates 1/2-13 Pistons
- ⊗ Air Inlet 1/4 N.P.T.
- ▲ No Alignment Specified-Center Stud Mounting is Standard
- ⊗ Combination Stud/Air Inlet Stud Outside Thread is 3/4-16
- ⊗ Studs Inside Thread (Air Inlet) is 1/4 N.P.T. Exceptions Will Be Noted on Part View as ⊗

Firestone

BELLOW NO. ASSEMBLY ORDER NO.	CROSS SECTION VIEW	BEAD PLATE TOP VIEW	BEAD PLATE BOTTOM VIEW	ASSEMBLY WEIGHT (lbs.)	REPLACES
29 W01-358-7275					Ridewell 1003587275C
215 W01-358-7230	<p>(includes-bolts, nuts & washers)</p>			42.2	Pollard Holland Hitch 6788
38D W01-358-7990					Watson & Chalin AS-0048
38 W01-358-7994					Watson & Chalin AS-0019-1F (ref. W01-358-8008)
38 W01-358-7995					Watson & Chalin AS-0048-1F (ref. W01-358-8032)

Hardware Key

- Bolt or Stud 1/2-13
- ⊙ Threaded Hole 3/8-16 Blind Nut on Bead Plates 1/2-13 Pistons
- ⊗ Air Inlet 1/4 N.P.T.
- ▲ No Alignment Specified-Center Stud Mounting is Standard
- ⊗ Combination Stud/Air Inlet Stud Outside Thread is 3/4-16
- ⊗ Studs Inside Thread (Air Inlet) is 1/4 N.P.T. Exceptions Will Be Noted on Part View as ⊗

Convolved Style Parts

BELLOW NO. ASSEMBLY ORDER NO.	CROSS SECTION VIEW	BEAD PLATE TOP VIEW	BEAD PLATE BOTTOM VIEW	ASSEMBLY WEIGHT (lbs.)	REPLACES
38 W01-358-7996					Granning 8221
38 W01-358-7998					Hendrickson Aux. 001560
38 W01-358-8006				16.1	Superior
38 W01-358-8008				17.7	EZ Ride Histeer Ridewell 1003588008C Silent Drive Watson & Chalin AS-0019 Hendrickson Trailer S11637
38 W01-358-8010				18.0	Ridewell 1003588010C Tafco Oshkosh (ref.8013)

Convolved Style Springs

Hardware Key

- Bolt or Stud 1/2-13
- ⊗ Threaded Hole 3/8-16 Blind Nut on Bead Plates 1/2-13 Pistons
- ⊗ Air Inlet 1/4 N.P.T.
- ▲ No Alignment Specified-Center Stud Mounting is Standard
- ⊗ Combination Stud/Air Inlet Stud Outside Thread is 3/4-16
- ⊗ Studs Inside Thread (Air Inlet) is 1/4 N.P.T. Exceptions Will Be Noted on Part View as ⊗

Firestone

BELLOW NO. ASSEMBLY ORDER NO.	CROSS SECTION VIEW	BEAD PLATE TOP VIEW	BEAD PLATE BOTTOM VIEW	ASSEMBLY WEIGHT (lbs.)	REPLACES
38 W01-358-8014				18.0	Ridewell 1003588014C
38 W01-358-8016					Ridewell 1003588016C
38 W01-358-8018				18.6	Histeer Reyco 93AR Suspensions Inc. Watson & Chalin
38 W01-358-8025					Silent Drive (replaces W01-358-8028) Van Raden
38 W01-358-8027					Suspensions Inc. 200117 Histeer (supercedes 8029) Silent Drive

Hardware Key

- Bolt or Stud 1/2-13
- ⊙ Threaded Hole 3/8-16 Blind Nut on Bead Plates 1/2-13 Pistons
- ⊗ Air Inlet 1/4 N.P.T.
- ▲ No Alignment Specified-Center Stud Mounting is Standard
- ⊗ Combination Stud/Air Inlet Stud Outside Thread is 3/4-16
- ⊗ Studs Inside Thread (Air Inlet) is 1/4 N.P.T. Exceptions Will Be Noted on Part View as ⊗

Convolved Style Parts

BELLOW NO. ASSEMBLY ORDER NO.	CROSS SECTION VIEW	BEAD PLATE TOP VIEW	BEAD PLATE BOTTOM VIEW	ASSEMBLY WEIGHT (lbs.)	REPLACES
38 W01-358-8030					Ridewell 1003588030C
38 W01-358-8032				17.7	Watson & Chalin AS-0048 Hendrickson Trailer S12405
354 W01-358-8033					Hendrickson Trailer S14487 (Ride Bag) [Paralift Ultra] [Pararev] Hendrickson Aux. 003316 (metric version)
354 W01-358-8038					Silent Drive Longer Stroke 8008 Histeer 10313
354 W01-358-8039					Histeer 10303 (Longer Stroke 8018)

Convolved Style Springs

Hardware Key

- Bolt or Stud 1/2-13 ⊗ Threaded Hole 3/8-16 Blind Nut on Bead Plates 1/2-13 Pistons ⊗ Air Inlet 1/4 N.P.T. ▲ No Alignment Specified-Center Stud Mounting is Standard
- ⊗ Combination Stud/Air Inlet Stud Outside Thread is 3/4-16 Studs Inside Thread (Air Inlet) is 1/4 N.P.T. Exceptions Will Be Noted on Part View as ⊗

Firestone

BELLOW NO. ASSEMBLY ORDER NO.	CROSS SECTION VIEW	BEAD PLATE TOP VIEW	BEAD PLATE BOTTOM VIEW	ASSEMBLY WEIGHT (lbs.)	REPLACES
352 W01-358-7954					Hendrickson Aux. 002348
352 W01-358-7956					Rowe Truck 0059 ASC 1500
352D W01-358-8042					Hendrickson Aux. 001015 Holland (Neway) 90557236 V-Steer II (Ride Bag)
352 W01-358-8043					Hendrickson Trailer S14795
313 W01-358-7796					Ridewell 1003587796C

Hardware Key

- Bolt or Stud 1/2-13
- ⊙ Threaded Hole 3/8-16 Blind Nut on Bead Plates 1/2-13 Pistons
- ⊗ Air Inlet 1/4 N.P.T.
- ▲ No Alignment Specified-Center Stud Mounting is Standard
- ⊗ Combination Stud/Air Inlet Stud Outside Thread is 3/4-16
- ⊗ Studs Inside Thread (Air Inlet) is 1/4 N.P.T. Exceptions Will Be Noted on Part View as ⊗

Convolved Style Parts

BELLOW NO. ASSEMBLY ORDER NO.	CROSS SECTION VIEW	BEAD PLATE TOP VIEW	BEAD PLATE BOTTOM VIEW	ASSEMBLY WEIGHT (lbs.)	REPLACES
313 W01-358-7797					Hendrickson Aux. 001346
313 W01-358-7798				23.3	Allison Granning 1613 R & S Truck & Body Watson & Chalin AS-0006
313 W01-358-7800				21.1	Granning 4514 Holland Hitch 4514 Ridewell 1003587800C Silent Drive
313 W01-358-7808				20.2	Ridewell 1003587808C Truckstell (Marion Mfg.) 63640 EZ Ride 8030170
313 W01-358-7818				24.2	EZ Ride 8030180 Granning 1014 Ridewell 1003587818C Superior Watson & Chalin AS-0025

Convolved Style Springs

Hardware Key

- Bolt or Stud 1/2-13
- ⊗ Threaded Hole 3/8-16 Blind Nut on Bead Plates 1/2-13 Pistons
- ⊗ Air Inlet 1/4 N.P.T.
- ▲ No Alignment Specified-Center Stud Mounting is Standard
- ⊗ Combination Stud/Air Inlet Stud Outside Thread is 3/4-16
- Studs Inside Thread (Air Inlet) is 1/4 N.P.T. Exceptions Will Be Noted on Part View as ⊗

Firestone

BELLOW NO. ASSEMBLY ORDER NO.	CROSS SECTION VIEW	BEAD PLATE TOP VIEW	BEAD PLATE BOTTOM VIEW	ASSEMBLY WEIGHT (lbs.)	REPLACES
39 W01-358-7816				23.5	Granning 1476 Superior Temisko
39 W01-358-7852					Porcupine Maurice Welding
333 W01-358-7838 WAS W01-358-7849				27.7	EZ Ride
333 W01-358-7839				28.4	Hendrickson Trailer S6861 Histeer 10300 Porcupine (replaces 7818) Ridewell Watson & Chalin AS-0033 Silent Drive Superior
333 W01-358-7843				28.3	Hendrickson Trailer S7100

Hardware Key

- Bolt or Stud 1/2-13
- ⊙ Threaded Hole 3/8-16 Blind Nut on Bead Plates 1/2-13 Pistons
- ⊗ Air Inlet 1/4 N.P.T.
- ▲ No Alignment Specified-Center Stud Mounting is Standard
- ⊗ Combination Stud/Air Inlet Stud Outside Thread is 3/4-16
- ⊗ Studs Inside Thread (Air Inlet) is 1/4 N.P.T. Exceptions Will Be Noted on Part View as ⊗

Convolved Style Parts

BELLOW NO. ASSEMBLY ORDER NO.	CROSS SECTION VIEW	BEAD PLATE TOP VIEW	BEAD PLATE BOTTOM VIEW	ASSEMBLY WEIGHT (lbs.)	REPLACES
333 W01-358-7844				30.0	Ridewell 1003587844C
333 W01-358-7845					EZ Ride
333 W01-358-7846				28.3	Hendrickson Trailer S7853
333 W01-358-7847				29.7	Hendrickson Trailer S8874
333 W01-358-7848				25.5	Superior Suspensions Inc.

Convolved Style Springs

Hardware Key

- Bolt or Stud 1/2-13
- ⊗ Threaded Hole 3/8-16 Blind Nut on Bead Plates 1/2-13 Pistons
- ⊗ Air Inlet 1/4 N.P.T.
- ▲ No Alignment Specified-Center Stud Mounting is Standard
- ⊗ Combination Stud/Air Inlet Stud Outside Thread is 3/4-16
- ⊗ Studs Inside Thread (Air Inlet) is 1/4 N.P.T. Exceptions Will Be Noted on Part View as ⊗

Firestone

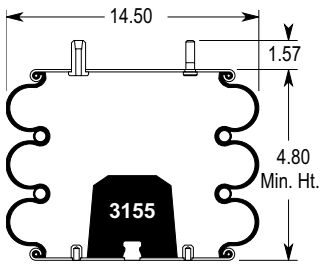
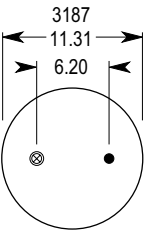
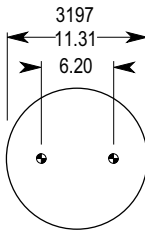
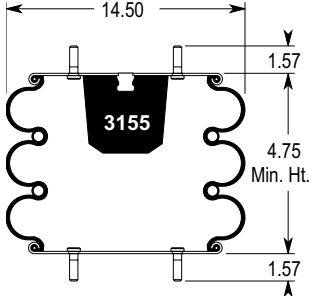
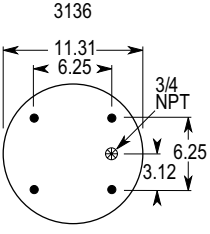
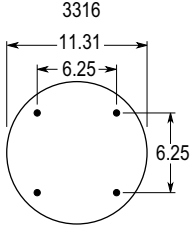
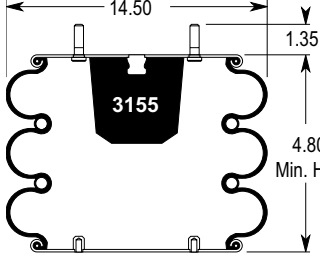
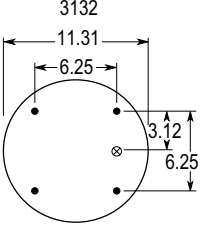
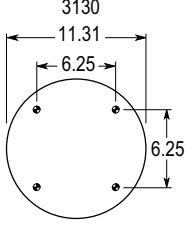
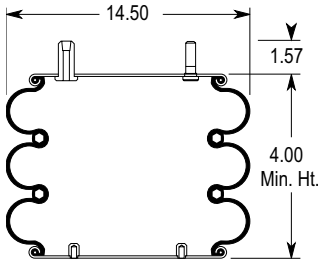
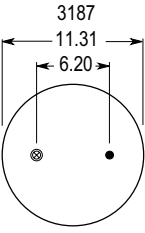
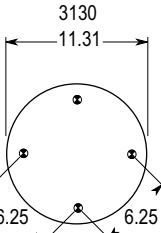
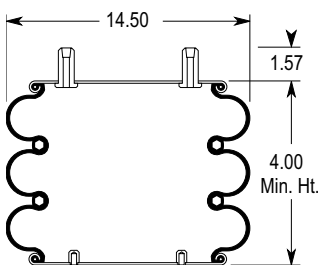
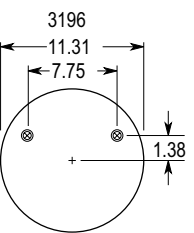
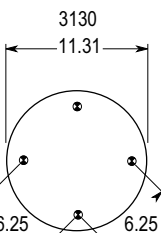
BELLOW NO. ASSEMBLY ORDER NO.	CROSS SECTION VIEW	BEAD PLATE TOP VIEW	BEAD PLATE BOTTOM VIEW	ASSEMBLY WEIGHT (lbs.)	REPLACES
333 W01-358-7850				28.5	Histeer 10301 Suspensions Inc. 200177 Watson & Chalin AS-0086 (Replaces old 7837 supersedes 7851 - adapter plates might be required)
333 W01-358-7853					Chalmers
333 W01-358-7855				N/A	Granning 7026
333 W01-358-7859					Hendrickson Aux. 001285
333 W01-358-7862					Hendrickson Aux. 001795 (Paralift Ultra/High Lift) -ride bag

Hardware Key

- Bolt or Stud 1/2-13
- ⊙ Threaded Hole 3/8-16 Blind Nut on Bead Plates 1/2-13 Pistons
- ⊗ Air Inlet 1/4 N.P.T.
- ▲ No Alignment Specified-Center Stud Mounting is Standard
- ⊗ Combination Stud/Air Inlet Stud Outside Thread is 3/4-16
- ⊗ Studs Inside Thread (Air Inlet) is 1/4 N.P.T. Exceptions Will Be Noted on Part View as ⊗

Convuluted Style Parts

BELLOW NO. ASSEMBLY ORDER NO.	CROSS SECTION VIEW	BEAD PLATE TOP VIEW	BEAD PLATE BOTTOM VIEW	ASSEMBLY WEIGHT (lbs.)	REPLACES
333 W01-358-7872					Hendrickson Aux. 004828
312 W01-358-7286				24.0	Ridewell 1003587286C Superior
312 W01-358-7761					Superior
312 W01-358-7915					Superior
323 W01-358-7274				52.5	Ridewell 1003587274C

Convuluted Style Springs

Hardware Key

- Bolt or Stud 1/2-13
- ⊗ Threaded Hole 3/8-16 Blind Nut on Bead Plates 1/2-13 Pistons
- ⊗ Air Inlet 1/4 N.P.T.
- ▲ No Alignment Specified-Center Stud Mounting is Standard
- ⊗ Combination Stud/Air Inlet Stud Outside Thread is 3/4-16
- ⊗ Studs Inside Thread (Air Inlet) is 1/4 N.P.T. Exceptions Will Be Noted on Part View as ⊗

Firestone

BELLOW NO. ASSEMBLY ORDER NO.	CROSS SECTION VIEW	BEAD PLATE TOP VIEW	BEAD PLATE BOTTOM VIEW	ASSEMBLY WEIGHT (lbs.)	REPLACES
320 W01-358-7276					Wabash
321 W01-358-7304	<p>(includes-bolts, nuts & washers)</p>			52.5	Ottawa 53500516 Pollard Holland Hitch 6764 Supersedes 7320

Hardware Key

- Bolt or Stud 1/2-13
- ◐ Threaded Hole 3/8-16 Blind Nut on Bead Plates 1/2-13 Pistons
- ⊗ Air Inlet 1/4 N.P.T.
- ▲ No Alignment Specified-Center Stud Mounting is Standard
- ⊗ Combination Stud/Air Inlet Stud Outside Thread is 3/4-16
- ⊗ Studs Inside Thread (Air Inlet) is 1/4 N.P.T. Exceptions Will Be Noted on Part View as ⊗

Convolutd Style Parts

BELLOW NO. ASSEMBLY ORDER NO.	CROSS SECTION VIEW	BEAD PLATE TOP VIEW	BEAD PLATE BOTTOM VIEW	ASSEMBLY WEIGHT (lbs.)	REPLACES

Convolutd Style Springs

Hardware Key

- Bolt or Stud 1/2-13
- ◐ Threaded Hole 3/8-16 Blind Nut on Bead Plates 1/2-13 Pistons
- ⊗ Air Inlet 1/4 N.P.T.
- ▲ No Alignment Specified-Center Stud Mounting is Standard
- ⊗ Combination Stud/Air Inlet Stud Outside Thread is 3/4-16
- ⊗ Studs Inside Thread (Air Inlet) is 1/4 N.P.T. Exceptions Will Be Noted on Part View as ⊗

Reading the parts table for sleeve style springs

1	2	3	4	5	6	7
ASSEMBLY ORDER NO.	CROSS SECTION VIEW	CAP	PISTON	BCR	ASSEMBLY WEIGHT (lbs.)	APPLICATIONS
		DRAWING NUMBER	DRAWING NUMBER	LOGO COLOR		
W02-358-7059		7042	6896	8.25"	N/A	NATIONAL SEATING 324663-01 (W02-N19-7059) 328035-01 (W02-N19-7069) 329666-01 (W02-N19-7084)
		NBD-10409	NBD-12708	Orange		

1. Order Number

This number identifies the specific assembly order number that needs to be used for ordering purposes. It is important that the complete order number is used to avoid any confusion, especially with any type of electronic ordering. The complete order number in the example is W02-358-7017.

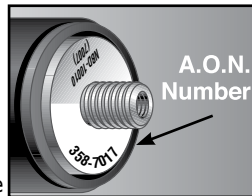

2. Cross Section View

This section is a cross sectional drawing of the Airide™ spring showing dimensional information in inches. The two heights shown to the right of the drawing are for extended and compressed measurements **uninflated**. The part number shown at the left is the last four digits of the A.O.N. (Airide™ Order Number). In the example, W02-358-7017 is abbreviated to "7017". The last 7 digits of the A.O.N. are stamped into the lip of the cap, around the perimeter. The AON number may also be stamped on the crimping.

3. Cap Drawing Number

Shown in this section of the table above is the drawing number molded into the material of most caps, followed by an additional four digit number enclosed in parentheses. The drawing numbers will generally start with the letters NBD. The four digit number is a stores number for this component, not an assembly identification number. In this book you will see another notation following the four digit number. This refers to the material that the cap is made of, specifically aluminum or plastic.

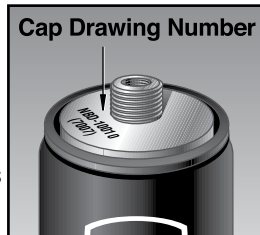

4. Piston Drawing Number

This section refers to the piston end of the sleeve. It is shown in the same way as the cap information.

5. BCR/Logo Color

This dimension is the measurement taken between the two metal rings on each end of the assembly. Note: BCR measurement on a used Airide™ spring will be somewhat shorter than specified in this catalog. The Airide™ spring shield logo color indicates a very specific construction of the bellows.

6. Weight

This is the total weight of the Airide™ spring assembly.

7. Applications

In this section, we provide all the information that is known about this specific application (i.e., model number, years of manufacture, part numbers, Firestone reference numbers and competitor numbers if known).

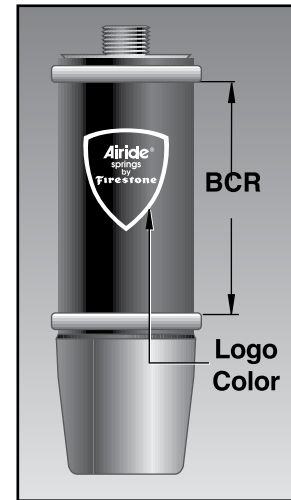

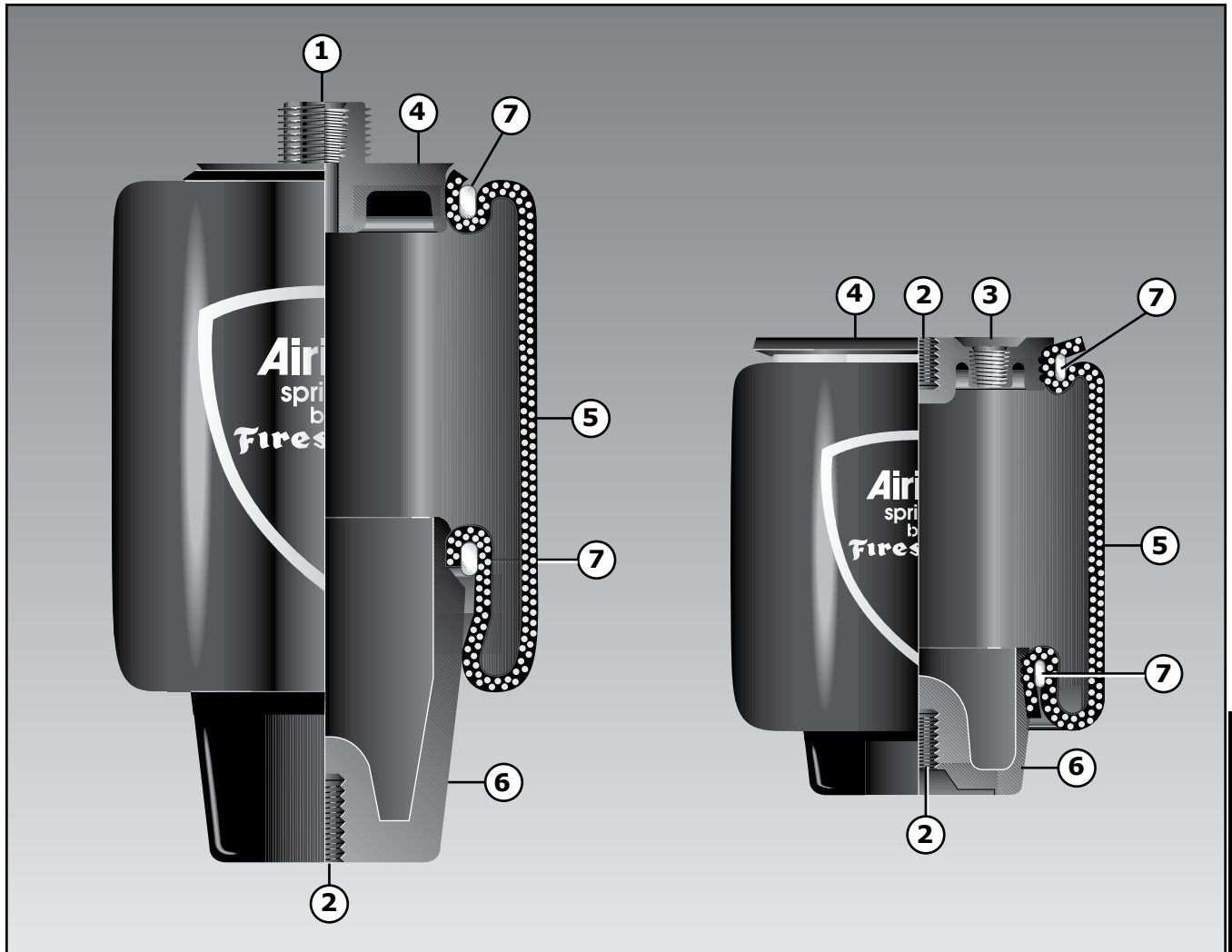

1. Combo Stud

Combination mounting stud and air fitting.

2. Blind Nut

A blind tapped hole in either the piston or cap.

3. Air Fitting Hole

When using a blind nut or stud instead of a combo stud, a separate air fitting is required.

4. Clamp Plate

Also called the "Cap", this is the upper aluminum or plastic end. This provides the mounting hardware, and normally the air fitting.

5. Bellows

The heart of an Airide™ spring is the sleeve, or bellows.

It is made of four layers: an inner liner of rubber, two plies of cord reinforcement, and an outer cover.

6. Piston

The lower end of the assembly that the rubber rolls over is called the "piston". This is also made of either aluminum or plastic. It provides the lower mounting hardware for the assembly.

7. Clamp Ring

These are the metal rings used to permanently attach the bellows to the clamp plate and piston.

Firestone

ASSEMBLY ORDER NO.	CROSS SECTION VIEW	CAP DRAWING NUMBER	PISTON DRAWING NUMBER	BCR LOGO COLOR	ASSEMBLY WEIGHT (lbs.)	APPLICATIONS
W01-358-7025		3030	3025		3.8	FREIGHTLINER / WESTERN STAR (style #25 bellows)
W02-358-7086		7018	7052	5.25"	0.7	LINK MANUFACTURING LTD 1102-0025 (Ford)
		NBD-10218	NBD-10552	Orange		
W02-358-7046		7068	7083	6"	0.7	LINK MANUFACTURING LTD 1102-0022 (Ford, Frt. GMC, Pete)
		NBD-10470	NBD-13727	Orange		
W02-358-7079		7074	7083	6"	0.7	LINK MANUFACTURING LTD 1102-0026 (Nav.)
		NBD-11636	NBD-13727	Orange		

INF. - Inflated (Max.) / UNINF. - Uninflated / (P) - Plastic / (AL) - Aluminum / BCR - Between Clamp Rings / N/A - Not Available

1T - Reversible Sleeve

ASSEMBLY ORDER NO.	CROSS SECTION VIEW	CAP DRAWING NUMBER	PISTON DRAWING NUMBER	BCR LOGO COLOR	ASSEMBLY WEIGHT (lbs.)	APPLICATIONS
W02-358-7001		7018	7052	6.75"	0.7	LINK MANUFACTURING LTD 1102-0020 (NAV.) see 1102-0023 1102-0023 (Ford, Frt, GMC, KW, Nav., Volvo) COMFORT RIDE WISE
		NBD-10218	NBD-10552	Orange		
W02-358-7150		7015	7083	7.00"	0.7	SEARS/DURAFORM S13384 (W02-811-7150)
		NBD-10239	NBD-13727	Orange		
W02-358-7201		7018	7052	7.25"	1.2	FREIGHTLINER / STERLING 18-45068-000 Sterling Day Cab Old Ford # P/N F6HT5C-06CAB HN-80 Day Cab (1996 & later)
		NBD-10218	NBD-10552	Orange		
W02-358-6754		7014	6996	7.50"	1	PETERBILT 20-16754 Day Cab (1994 & later) Dynacraft D5000-2250
		NBD-10082	NBD-13499	Orange		

Sleeve Style Springs

INF. - Inflated (Max.) / UNINF. - Uninflated / (P) - Plastic / (AL) - Aluminum / BCR - Between Clamp Rings / N/A - Not Available

Firestone

ASSEMBLY ORDER NO.	CROSS SECTION VIEW	CAP DRAWING NUMBER	PISTON DRAWING NUMBER	BCR LOGO COLOR	ASSEMBLY WEIGHT (lbs.)	APPLICATIONS
W02-358-7100		7068	7083	7.50"	0.7	3-T'S W02-T03-7100
		NBD-10470	NBD-13727	Orange		
W02-358-7155		6991	6996	7.50"	1	PETERBILT 20-19036 Uni-Built Highway Front Support Spring Dynacraft D5000-2253
		NBD-14314	NBD-13499	Orange		
W02-358-7041		7015	7033	8.25"	1.2	SEARS / DURAFORM S8645 (W02-811-7041)
		NBD-10239	NBD-10238	Orange		
W02-358-7059		7042	6896	8.25"	1.3	NATIONAL SEATING 324663-01 (W02-N19-7059) 328035-01 (W02-N19-7069) 329666-01 (W02-N19-7084)
		NBD-10409	NBD-12708	Orange		

INF. - Inflated (Max.) / UNINF. - Uninflated / (P) - Plastic / (AL) - Aluminum / BCR - Between Clamp Rings / N/A - Not Available

1T - Reversible Sleeve

ASSEMBLY ORDER NO.	CROSS SECTION VIEW	CAP DRAWING NUMBER	PISTON DRAWING NUMBER	BCR LOGO COLOR	ASSEMBLY WEIGHT (lbs.)	APPLICATIONS
W02-358-7058		7042	6896	9.00"	1.3	NATIONAL SEATING 324662-01 (W02-N19-7058)
		NBD-10409	NBD-12708	Orange		
W02-358-7076		7007	7054	9.25"	0.8	RIDE-RITE
		NBD-10010	NBD-10795	Orange		
W02-358-7054		7018	7041	9.25"	1.2	WISE
		NBD-10218	NBD-10215	Orange		
W02-358-7098		6997	7041	9.62"	1.2	LINK MANUFACTURING LTD 1102-0027
		NBD-13262	NBD-10215	Orange		

Sleeve Style Springs

INF. - Inflated (Max.) / UNINF. - Uninflated / (P) - Plastic / (AL) - Aluminum / BCR - Between Clamp Rings / N/A - Not Available

Firestone

ASSEMBLY ORDER NO.	CROSS SECTION VIEW	CAP DRAWING NUMBER	PISTON DRAWING NUMBER	BCR LOGO COLOR	ASSEMBLY WEIGHT (lbs.)	APPLICATIONS
W02-358-7040		7015	7033	10.00"	1.2	KNOEDLER 7010 AL (use 7040) (W02-K50-7060) SEARS / DURAFORM S5388 SEATS 707338 AIR FLEX
		NBD-10239	NBD-10238	Orange		
W02-358-7049		7068	7033	10.00"	1.2	3-T'S W02-T03-7049
		NBD-10470	NBD-10238	Orange		
W02-358-7055		7042	7047	10.00"	1.2	NATIONAL SEATING 2112283 7050 Plastic (use 7055)
		NBD-10409	NBD-10526	Orange		
W02-358-7149		7068	6896	10.00"	1.3	3-T'S W02-T03-7149
		NBD-10470	NBD-12708	Orange		

INF. - Inflated (Max.) / UNINF. - Uninflated / (P) - Plastic / (AL) - Aluminum / BCR - Between Clamp Rings / N/A - Not Available

1T - Reversible Sleeve

ASSEMBLY ORDER NO.	CROSS SECTION VIEW	CAP DRAWING NUMBER	PISTON DRAWING NUMBER	BCR LOGO COLOR	ASSEMBLY WEIGHT (lbs.)	APPLICATIONS
W02-358-7073		7013	7023	11.00"	1.4	CARE CONCEPT
		NBD-10183	NBD-10071	Orange		
W02-358-9901		7066	7059	16.37"	3.9	PETERBILT 02-02031 Front Axle Air Spring (production-1989 to 1992)
		NAD-25400	NBD-11340	Orange		
W02-358-7031		7014	7049	7.00"	1.3	MACK 227QS33 GY 154-007
		NBD-10082	NBD-10549	Green		
W02-358-7209		7042	6979	7.00"	1.3	SEATS 708220 (W02-812-7209)
		NBD-10409	FIP-100105	Green		

INF. - Inflated (Max.) / UNINF. - Uninflated / (P) - Plastic / (AL) - Aluminum / BCR - Between Clamp Rings / N/A - Not Available

Firestone

ASSEMBLY ORDER NO.	CROSS SECTION VIEW	CAP DRAWING NUMBER	PISTON DRAWING NUMBER	BCR LOGO COLOR	ASSEMBLY WEIGHT (lbs.)	APPLICATIONS
W02-358-7106		6997	7047	9.87"	1.2	LINK MANUFACTURING LTD 1102-0030 (Pete.)
		NBD-13262	NBD-10526	Green		
W02-358-7085		7013	7023	11.5"	N/A	AIR FLEX (W02-A05-7085)
		NBD-10183	NBD-10071	Green		
W02-358-7007		7005	7049	6.25"	1.3	MACK 227QS34 GY 1S6-067
		NBD-9930	NBD-10549	Red		
W02-358-7204		6990	7052	8.00"	1.4	FREIGHTLINER / STERLING Sterling Actera 18-43472-000
		NBD-13706	NBD-10552	Red		

INF. - Inflated (Max.) / UNINF. - Uninflated / (P) - Plastic / (AL) - Aluminum / BCR - Between Clamp Rings / N/A - Not Available

1T - Reversible Sleeve

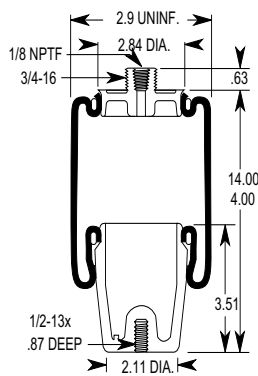
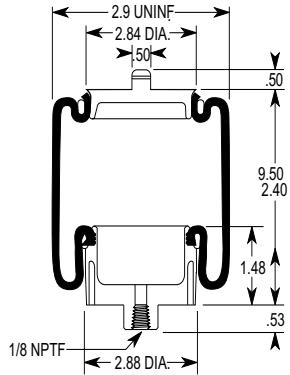
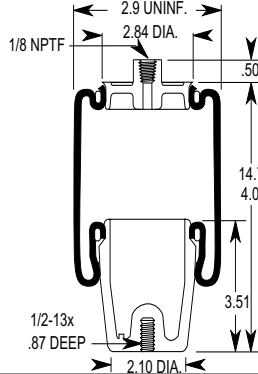
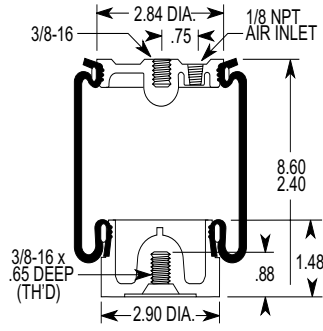
ASSEMBLY ORDER NO.	CROSS SECTION VIEW	CAP DRAWING NUMBER	PISTON DRAWING NUMBER	BCR LOGO COLOR	ASSEMBLY WEIGHT (lbs.)	APPLICATIONS
W02-358-7080		7015	7033	10"	1.2	LINK MANUFACTURING LTD 1102-0031 (Frt.)
		NBD-10239	NBD-10238	Red		
W02-358-7070		7042	6998	7.5"	0.7	NATIONAL SEATING 2123403 (W02-N19-7070)
		NBD-10409	NBD-12802	Pink		
W02-358-7116		7050	7033	13.38"	1.2	LINK MANUFACTURING 1101-0030
		NBD-10604	NBD-10238	Pink		
W02-358-7035		7068	7083	6.5"	0.7	SEARS / DURAFORM S9383 (W02-811-7035) 7025 AL (use 7035)
		NBD-10470	NBD-13727	White		

INF. - Inflated (Max.) / UNINF. - Uninflated / (P) - Plastic / (AL) - Aluminum / BCR - Between Clamp Rings / N/A - Not Available

Firestone

ASSEMBLY ORDER NO.	CROSS SECTION VIEW	CAP DRAWING NUMBER	PISTON DRAWING NUMBER	BCR LOGO COLOR	ASSEMBLY WEIGHT (lbs.)	APPLICATIONS
W02-358-7206		6987	6986	6.5"	1.2	FREIGHTLINER 18-29919-000 Century Class & Argosy COE (W02-377-7202) 2002 and earlier (replaces 7202)
		NBD-15430	NBD-15431	White		
W02-358-7087		7042	6998	6.75"	0.7	FREIGHTLINER FLD (1988 & later) GY 1S5-040
		NBD-10409	NBD-12802	White		
W02-358-7075		7018	7052	7.75"	0.7	LINK MANUFACTURING LTD 1102-0048
		NBD-10218	NBD-10552	White		
W02-358-7103		7068	7083	7.75"	0.7	3-T'S W02-T03-7103
		NBD-10470	NBD-13727	White		

INF. - Inflated (Max.) / UNINF. - Uninflated / (P) - Plastic / (AL) - Aluminum / BCR - Between Clamp Rings / N/A - Not Available

1T - Reversible Sleeve

ASSEMBLY ORDER NO.	CROSS SECTION VIEW	CAP DRAWING NUMBER	PISTON DRAWING NUMBER	BCR LOGO COLOR	ASSEMBLY WEIGHT (lbs.)	APPLICATIONS
W02-358-7037		7013	7054	8.0"	0.7	AIR FLEX (W02-A05-7037)
		NBD-10183	NBD-10795	White		
W02-358-7061		7042	7052	8"	0.7	C. E. WHITE
		NBD-10409	NBD-10552	White		
W02-358-7074		6997	7041	10.12"	1.2	FREIGHTLINER Link (1102-0047) LINK MANUFACTURING LTD 1102-0045 1102-0047 (Frt.)
		NBD-13262	NBD-10215	White		
W02-358-7012		7007	7023	10.87"	1.5	LINK MANUFACTURING LTD 1102-0040 RIDE-RITE VANTAGE WHEEL CHAIR
		NBD10010	NBD-10071	White		

Sleeve Style Springs

INF. - Inflated (Max.) / UNINF. - Uninflated / (P) - Plastic / (AL) - Aluminum / BCR - Between Clamp Rings / N/A - Not Available

Firestone

ASSEMBLY ORDER NO.	CROSS SECTION VIEW	CAP DRAWING NUMBER	PISTON DRAWING NUMBER	BCR LOGO COLOR	ASSEMBLY WEIGHT (lbs.)	APPLICATIONS
W02-358-7032		7068	7033	10.87"	1.2	CARE CONCEPT 7022 AL (use 7032)
		NBD-10470	NBD-10238	White		INDEPENDENT MOBILITY 3-T'S
W02-358-7042		7015	7033	10.87"	1.2	COMFORT RIDE
		NBD-10239	NBD-10238	White		
W02-358-7045		7042	7041	10.87"	1.2	LINK MANUFACTURING LTD 1102-0042 (Western Star)
		NBD-10409	NBD-10215	White		
W02-358-7056		6997	7047	10.87"	1.2	LINK MANUFACTURING LTD 1102-0043 (Fr. KW, Mack)
		NBD-13262	NBD-10526	White		

INF. - Inflated (Max.) / UNINF. - Uninflated / (P) - Plastic / (AL) - Aluminum / BCR - Between Clamp Rings / N/A - Not Available

1T - Reversible Sleeve

ASSEMBLY ORDER NO.	CROSS SECTION VIEW	CAP DRAWING NUMBER	PISTON DRAWING NUMBER	BCR LOGO COLOR	ASSEMBLY WEIGHT (lbs.)	APPLICATIONS
W02-358-7151		7068	7033	10.87"	1.4	SEARS/DURAFORM S16894 (W02-811-7151)
		NBD-10470	NBD-10238	White		Piston Adaptor 7802/NBD 14989
W02-358-7208		6978	7033	11.12"	1	SEATS 708015 (W02-812-7208)
		FIP-100102	NBD-10238	White		
W02-358-7067		7013	7023	11.5"	1.5	AIR FLEX (W02-A05-7067)
		NBD-10183	NBD-10071	White		
W02-358-7029		7068	7033	11.75"	1.2	CARE CONCEPT
		NBD-10470	NBD-10238	White		INDEPENDENT MOBILITY

Sleeve Style Springs

INF. - Inflated (Max.) / UNINF. - Uninflated / (P) - Plastic / (AL) - Aluminum / BCR - Between Clamp Rings / N/A - Not Available

Firestone

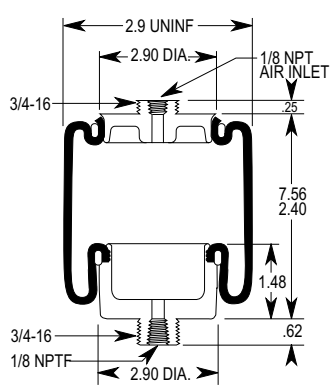
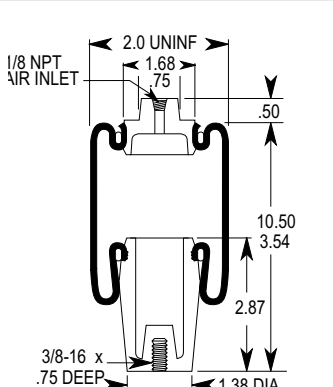
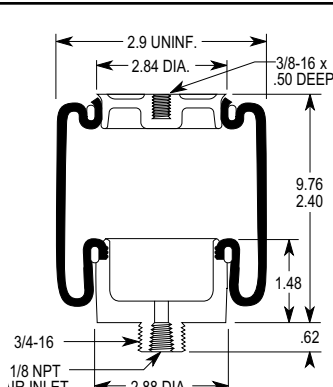
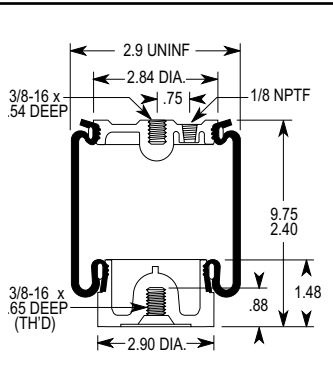
ASSEMBLY ORDER NO.	CROSS SECTION VIEW	CAP DRAWING NUMBER	PISTON DRAWING NUMBER	BCR LOGO COLOR	ASSEMBLY WEIGHT (lbs.)	APPLICATIONS
W02-358-7017		7007	7023	11.5"	1.5	MACK 227QS38
		NBD-10010	NBD-10071	Maroon		
W02-358-4003		7009	7044	7.25"	N/A	COMFORT RIDE SEARS / DURAFORM S6197 (W02-811-4003)
		NBD-10049	NBD-10514	Yellow		
W02-358-7064		7018	7052	7.75"	0.7	KENWORTH KW Aerocab (mid 1999 & earlier) Link (1102-0074) LINK MANUFACTURING LTD 1102-0074 (KW, MARMON)
		NBD-10218	NBD-10552	Yellow		
W02-358-7108		7068	7083	7.75"	0.7	LINK MANUFACTURING LTD 1102-0075 (Nav.) MILSCO 07067A GY 155-057
		NBD-10470	NBD-13727	Yellow		

INF. - Inflated (Max.) / UNINF. - Uninflated / (P) - Plastic / (AL) - Aluminum / BCR - Between Clamp Rings / N/A - Not Available

1T - Reversible Sleeve

ASSEMBLY ORDER NO.	CROSS SECTION VIEW	CAP DRAWING NUMBER	PISTON DRAWING NUMBER	BCR LOGO COLOR	ASSEMBLY WEIGHT (lbs.)	APPLICATIONS
W02-358-7109		6990	6894	7.87"	1	KENWORTH KW Aerocab (mid 1999 & later) Link (1102-0077) LINK MANUFACTURING LTD 1102-0077 (KW)
		NBD-13706	NBD-14218	Yellow		
W02-358-7038		7013	7054	8.0"	1.4	AIR FLEX 7048 AL (use 7038) DONVEL
		NBD-10183	NBD-10795	Yellow		
W02-358-7205		6987	6986	8.0"	1.2	FREIGHTLINER / WESTERN STAR Constellation (supersedes 7203)
		NBD-15430	NBD-15431	yellow		
W02-358-7082		7018	7052	8.25"	0.7	FREIGHTLINER / WESTERN STAR
		NBD-10218	NBD-10552	Yellow		

INF. - Inflated (Max.) / UNINF. - Uninflated / (P) - Plastic / (AL) - Aluminum / BCR - Between Clamp Rings / N/A - Not Available

Firestone

ASSEMBLY ORDER NO.	CROSS SECTION VIEW	CAP DRAWING NUMBER	PISTON DRAWING NUMBER	BCR LOGO COLOR	ASSEMBLY WEIGHT (lbs.)	APPLICATIONS
W02-358-7036		7014	7069	10"	1.4	PETERBILT 29-03200 Uni-built-Highway Cab/ Sleeper 1993 & later Uni-built ft Support Spring 7155
		NBD-10082	NBD-12816	Yellow		
W02-358-7024		7007	7023	10.0"	1.5	LINK MANUFACTURING LTD 1102-0071
		NBD-10010	NBD-10071	Yellow		
W02-358-7043		7013	7023	11.5"	1.4	DONVEL
		NBD-10183	NBD-10071	Yellow		
W02-358-7044		7015	7033	11.5"	1.2	AIR FLEX 7014 AL (use 7044) LINK MANUFACTURING LTD 1102-0070 7014 AL (use 7044)
		NBD-10239	NBD-10238	Yellow		

INF. - Inflated (Max.) / UNINF. - Uninflated / (P) - Plastic / (AL) - Aluminum / BCR - Between Clamp Rings / N/A - Not Available

1T - Reversible Sleeve

ASSEMBLY ORDER NO.	CROSS SECTION VIEW	CAP DRAWING NUMBER	PISTON DRAWING NUMBER	BCR LOGO COLOR	ASSEMBLY WEIGHT (lbs.)	APPLICATIONS
W02-358-7081		7074	7033	11.5"	1.2	NAVISTAR Link 1102-0076 Link 1101-0043 GY 155-038
		NBD-11636	NBD-10238	Yellow		LINK MANUFACTURING LTD 1102-0076 (NAV.)
W02-358-7152		7068	7083	6.50"	1	KNOEDLER 100095-000 (W02-K50-7152)
		NBD-10470	NBD-13727	Blue		
W02-358-7092		7018	7052	8.75"	0.7	KENWORTH KWCSA (Link 1102-0083)
		NBD-10218	NBD-10552	Blue		LINK MANUFACTURING LTD 1102-0083 (KW)
W02-358-7093		6991	6891	10.0"	1.4	PETERBILT 29-06016 Model 387 (new in 1999)
		NBD-14314	NBD-14589	Blue		

INF. - Inflated (Max.) / UNINF. - Uninflated / (P) - Plastic / (AL) - Aluminum / BCR - Between Clamp Rings / N/A - Not Available

Firestone

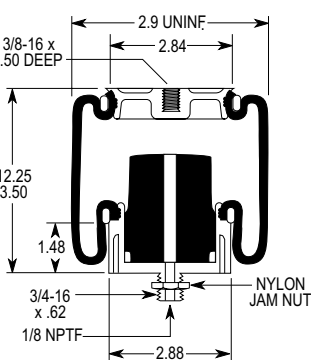
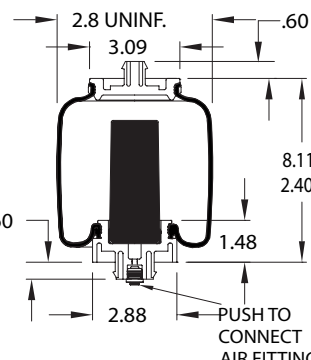
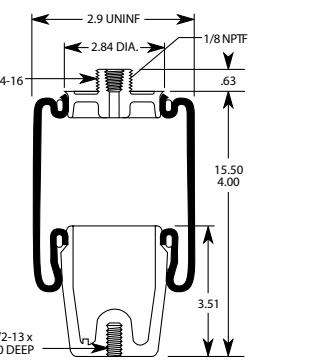
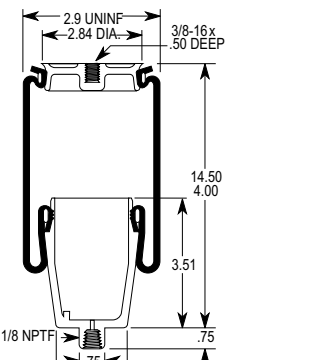
ASSEMBLY ORDER NO.	CROSS SECTION VIEW	CAP DRAWING NUMBER	PISTON DRAWING NUMBER	BCR LOGO COLOR	ASSEMBLY WEIGHT (lbs.)	APPLICATIONS
W02-358-7200		7018	7052	10.25"	1.2	FREIGHTLINER / STERLING 18-42609-000 Sterling Sleeper Old Ford # P/N F6HT5C-063BA HN-80 Sleeper (1996 & later)
		NBD-10218	NBD-10552	Blue		
W02-358-7215 WAS W01-358-7207		6987	6986	10.43"	2.0	FREIGHTLINER 18-40977-000 Centruy Class St (Supersedes by 7111)
		NBD-15430	NBD-15431	Yellow		
W02-358-7083		7015	7033	11.5"	1.2	LINK MANUFACTURING LTD 1102-0081 (Frt.)
		NBD-10239	NBD-10238	Blue		
W02-358-7110		7018	7047	11.75"	1.2	KENWORTH T2000-1998 & later Link (1102-0082) LINK MANUFACTURING LTD 1102-0082 (KW)
		NBD-10218	NBD-10526	Blue		

INF. - Inflated (Max.) / UNINF. - Uninflated / (P) - Plastic / (AL) - Aluminum / BCR - Between Clamp Rings / N/A - Not Available

1T - Reversible Sleeve

ASSEMBLY ORDER NO.	CROSS SECTION VIEW	CAP DRAWING NUMBER	PISTON DRAWING NUMBER	BCR LOGO COLOR	ASSEMBLY WEIGHT (lbs.)	APPLICATIONS
W02-358-9902		6700	6897	8"		LINK MANUFACTURING LTD 1102-0080
		NBD-13938	NBD-13939	N/A		
W21-760-9000		6988	7572	9.9"		RIDE-RITE (Long Part)
		NBD-15305	NBD-14048			
W21-760-9001		6988	7572	7.9"		RIDE-RITE (Short Part)
		NBD-15305	NBD-14048			
W21-760-9002		6988	7572	8.9"		RIDE-RITE (Medium Part)
		NBD-15305	NBD-14048			

INF. - Inflated (Max.) / UNINF. - Uninflated / (P) - Plastic / (AL) - Aluminum / BCR - Between Clamp Rings / N/A - Not Available

Firestone

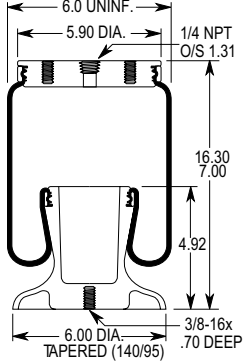
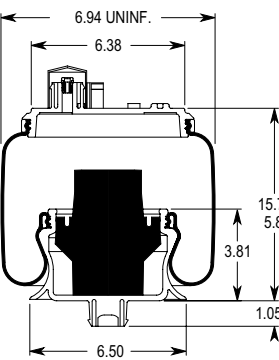
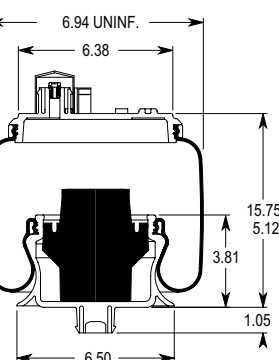
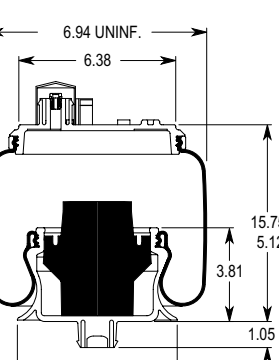
ASSEMBLY ORDER NO.	CROSS SECTION VIEW	CAP DRAWING NUMBER	PISTON DRAWING NUMBER	BCR LOGO COLOR	ASSEMBLY WEIGHT (lbs.)	APPLICATIONS
W21-760-9011		7526	7571	12.8"		RIDE-RITE W21-760-9010 (use 9011)
		NBD-14584	NAD-28088	N/A		
W26-358-9911		6711	6890	12.13"	4.7	HENDRICKSON TRUCK 59823-2 (W26-455-9911)
		NAD-30942	NAD-30940	N/A		
W26-358-9913		6713	6888	12.13"	4.7	HENDRICKSON TRUCK 60750-2 (W26-455-9913)
		NAD-30942	NAD-31336	N/A		
W26-358-9912		6714	6888	12.13"	4.7	HENDRICKSON TRUCK 64075-2 (W26-455-9912)
		NAD-30942	NAD-31336	N/A		

INF. - Inflated (Max.) / UNINF. - Uninflated / (P) - Plastic / (AL) - Aluminum / BCR - Between Clamp Rings / N/A - Not Available

1T - Reversible Sleeve

ASSEMBLY ORDER NO.	CROSS SECTION VIEW	CAP DRAWING NUMBER	PISTON DRAWING NUMBER	BCR LOGO COLOR	ASSEMBLY WEIGHT (lbs.)	APPLICATIONS

Sleeve Style Springs

INF. - Inflated (Max.) / UNINF. - Uninflated / (P) - Plastic / (AL) - Aluminum / BCR - Between Clamp Rings / N/A - Not Available

Firestone

Sleeve Cross Reference by Manufacturer

Manufacturer Name/ Part Number	Firestone AON	Page No.
3-T'S		
W02-T03-7100	W02-358-7100	138
W02-T03-7049	W02-358-7049	140
W02-T03-7149	W02-358-7149	140
7022 AL (use 7032)	W02-358-7032	146
W02-T03-7103	W02-358-7103	144
AIR FLEX		
(W02-A05-7085)	W02-358-7085	142
(W02-A05-7037)	W02-358-7037	145
(W02-A05-7067)	W02-358-7067	147
7048 AL (use 7038)	W02-358-7038	149
7014 AL (use 7044)	W02-358-7044	150
	W02-358-7040	140
C. E. WHITE		
	W02-358-7061	145
CARE CONCEPT		
	W02-358-7073	141
7022 AL (use 7032)	W02-358-7032	146
	W02-358-7029	147
	W02-358-7042	146
	W02-358-4003	148
CENTURY CLASS & ARGOSY COE (W02-377-7202) 2002 and earlier		
	W02-358-7206 (replaces 7202)	144
	W02-358-7215 (Supersedes by 7111)	152
COMFORT RIDE		
	W02-358-7001	137
DAY CAB (1994 & later)		
	W02-358-6754	137
DONVEL		
	W02-358-7043	150

Manufacturer Name/ Part Number	Firestone AON	Page No.
DONVEL cont.		
	W02-358-7038	149
DYNACRAFT		
D5000-2250	W02-358-6754	137
D5000-2253	W02-358-7155	138
FREIGHTLINER		
18-29919-000	W02-358-7206	144
FLD (1988 & later)	W02-358-7087	144
Link (1102-0047)	W02-358-7074	145
18-40977-000	W02-358-7215	152
FREIGHTLINER / STERLING		
18-45068-000 Sterling Day Cab	W02-358-7201	137
Sterling Actera	W02-358-7204	142
18-42609-000 Sterling Sleeper	W02-358-7200	152
FREIGHTLINER / WESTERN STAR		
(style #25 bellows)	W01-358-7025	136
Constellation	W02-358-7205 (supersedes 7203)	149
	W02-358-7082	149
GOODYEAR		
GY 1S4-007	W02-358-7031	141
GY 1S5-038	W02-358-7081	151
GY 1S5-040	W02-358-7087	144
GY 1S5-057	W02-358-7108	148
GY 1S6-067	W02-358-7007	142
HENDRICKSON TRUCK		
59823-2 (W26-455-9911)	W26-358-9911	154
60750-2 (W26-455-9913)	W26-358-9913	154
64075-2 (W26-455-9912)	W26-358-9912	154
INDEPENDENT MOBILITY		
	W02-358-7032	146
	W02-358-7029	147

Cross References

Sleeve Cross Reference by Manufacturer

Manufacturer Name/ Part Number	Firestone AON	Page No.
KENWORTH		
KW Aerocab (mid 1999 & earlier)	W02-358-7064	148
KW Aerocab (mid 1999 & later)	W02-358-7109	149
KWCSA (Link 1102-0083)	W02-358-7092	151
T2000-1998 & later	W02-358-7110	152
KNOEDLER		
7010 AL (use 7040) (W02-K50-7060)	W02-358-7040	140
100095-000 (W02-K50-7152)	W02-358-7152	151
LINK MANUFACTURING		
1101-0030	W02-358-7116	143
1102-0025 (Ford)	W02-358-7086	136
1102-0022 (Ford, Frt. GMC, Pete)	W02-358-7046	136
1102-0023 (Ford, Frt, GMC, KW, Nav., Volvo)	W02-358-7001	137
1102-0026 (Nav.)	W02-358-7079	136
1102-0020 (NAV.) see 1102-0023	W02-358-7001	137
1102-0027	W02-358-7098	139
1102-0030 (Pete.)	W02-358-7106	142
1102-0031 (Frt.)	W02-358-7080	143
1102-0045	W02-358-7074	145
1102-0047 (Frt.)	W02-358-7074	145
1102-0048	W02-358-7075	144
1102-0040	W02-358-7012	145
1102-0071	W02-358-7024	150

Manufacturer Name/ Part Number	Firestone AON	Page No.
LINK MANUFACTURING cont.		
1102-0074 (KW, MARMON)	W02-358-7064	148
1102-0077 (KW)	W02-358-7109	149
1102-0080	W02-358-9902	153
1102-0081 (Frt.)	W02-358-7083	152
1102-0082 (KW)	W02-358-7110	152
1102-0083 (KW)	W02-358-7092	151
MACK		
227QS33	W02-358-7031	141
227QS34	W02-358-7007	142
227QS38	W02-358-7017	148
MILSCO		
07067A	W02-358-7108	148
NATIONAL SEATING		
2112283	W02-358-7055	140
2123403 (W02-N19-7070)	W02-358-7070	143
324663-01 (W02-N19-7059)	W02-358-7059	138
324662-01 (W02-N19-7058)	W02-358-7058	139
328035-01 (W02-N19-7069)	W02-358-7059	138
329666-01 (W02-N19-7084)	W02-358-7059	138
NAVISTAR		
Link 1102-0076	W02-358-7081	151
Link 1101-0043	W02-358-7081	151
PETERBILT		
20-16754	W02-358-6754	137
20-19036	W02-358-7155	138
02-02031	W02-358-9901	141
29-03200	W02-358-7036	150
29-06016	W02-358-7093	151
RIDE-RITE		
	W02-358-7012	145
	W02-358-7076	139

Firestone

Sleeve Cross Reference by Manufacturer

Manufacturer Name/ Part Number	Firestone AON	Page No.
RIDE-RITE cont.		
(Long Part)	W21-760-9000	153
(Short Part)	W21-760-9001	153
(Medium Part)	W21-760-9002	153
W21-760-9010 (use 9011)	W21-760-9011	154
SEARS / DURAFORM		
S5388	W02-358-7040	140
S6197 (W02-811-4003)	W02-358-4003	148
S8645 (W02-811-7041)	W02-358-7041	138
S9383 (W02-811-7035)	W02-358-7035	143
S13384 (W02-811-7150)	W02-358-7150	137
S16894 (W02-811-7151)	W02-358-7151	147
SEATS		
707338	W02-358-7040	140
708220	W02-358-7209	141
708015	W02-358-7208	147
UNI-BUILT HIGHWAY		
	W02-358-7155 Front Support Spring	138
	W02-358-7036 Support Spring 7155	150
VANTAGE WHEEL CHAIR		
	W02-358-7012	145
WISE		
	W02-358-7054	139
	W02-358-7001	137

Cross References

Sleeve Index by Cap Drawing Number

Cap Drawing No.	Cap Comp No.	Material	AON's (W02-358-)	Page No.
FIP-100102	6978	Plastic	7208	147
NAD-25400	7066	Plastic	9901	141
NAD-30942	6711	Plastic	W26-358-9911	154
NAD-30942	6713	Plastic	W26-358-9913	154
NAD-30942	6714	Plastic	W26-358-9912	154
NBD-10010	7007	Aluminum	7076, 7012, 7017, 7024	139, 145, 148, 150
NBD-10049	7009	Aluminum	4003	148
NBD-10082	7014	Aluminum	6754, 7031, 7036	137, 141, 150
NBD-10183	7013	Aluminum	7073, 7085, 7037, 7067, 7038, 7043	141, 142, 145, 147, 149, 150
NBD-10218	7018	Plastic	7086, 7001, 7201, 7054, 7064, 7082, 7092, 7200, 7110	136, 137, 139, 144, 148, 149, 151, 152
NBD-10239	7015	Plastic	7150, 7041, 7040, 7080, 7042, 7044, 7083,	137, 138, 140, 143, 146, 150, 152
NBD-10409	7042	Plastic	7059, 7058, 7055, 7209, 7070, 7087, 7061, 7045	138, 139, 140, 141, 143, 144, 145, 146
NBD-10470	7068	Plastic	7046, 7100, 7049, 7149, 7035, 7103, 7032, 7151, 7029, 7108, 7152	136, 138, 140, 143, 144, 146, 147, 148, 151
NBD-10604	7050	Plastic	7116	143
NBD-11636	7074	Plastic	7079, 7081	136, 151
NBD-13262	6997	Plastic	7098, 7106, 7074, 7056	139, 142, 145, 146
NBD-13706	6990	Plastic	7204, 7109	142, 149
NBD-13938	6700	Aluminum	9902	153
NBD-14314	6991	Plastic	7155, 7093	138, 151
NBD-14584	7526	Aluminum	W21-760-9011	154
NBD-15305	6988	Aluminum	9000, 9001, 9002	153
NBD-15430	6987	Plastic	7206, 7205, 7215	144, 149, 152
NBD-9930	7005	Aluminum	7007	142

Firestone

Sleeve Index by Piston Drawing Number

Piston Drawing No.	Piston Comp No.	Material	AON's (W02-358-)	Page No.
FIP-100105	6979	Plastic	7209	141
NAD-28088	7571	Plastic	W21-760-9011	154
NAD-30940	6890	Plastic	W26-358-9911	154
NAD-31336	6888	Plastic	W26-358-9913, 9912	154
NBD-10071	7023	Aluminum	7012, 7017, 7024, 7073, 7085, 7067, 7043	141, 142, 145, 147, 148, 150
NBD-10215	7041	Plastic	7098, 7074, 7054, 7045	139, 145, 146
NBD-10238	7033	Plastic	7208, 7041, 7040, 7080, 7042, 7044, 7083, 7116, 7049, 7032, 7151, 7029, 7081	138, 140, 143, 146, 147, 150, 151, 152
NBD-10514	7044	Aluminum	4003	148
NBD-10526	7047	Plastic	7106, 7056, 7110, 7055	140, 142, 146, 152
NBD-10549	7049	Aluminum	7007, 7031	141, 142
NBD-10552	7052	Plastic	7204, 7086, 7001, 7201, 7075, 7064, 7082, 7092, 7200, 7061	136, 137, 142, 144, 145, 148, 149, 151, 152
NBD-10795	7054	Aluminum	7076, 7037, 7038	139, 145, 149
NBD-11340	7059	Plastic	9901	141
NBD-12708	6896	Plastic	7059, 7058, 7149	138, 139, 140
NBD-12802	6998	Plastic	7070, 7087	143, 144
NBD-12816	7069	Aluminum	7036	150
NBD-13499	6996	Plastic	7155, 6754	137, 138
NBD-13727	7083	Plastic	7150, 7046, 7100, 7035, 7103, 7108, 7152, 7079	136, 137, 138, 143, 144, 148, 151
NBD-13939	6897	Aluminum	9902	153
NBD-14048	7572	Aluminum	9000, 9001, 9002	153
NBD-14218	6894	Plastic	7109	149
NBD-14589	6891	Plastic	7093	151
NBD-15431	6986	Plastic	7206, 7205, 7215	144, 149, 152

Cross References

Sleeve Index by Cap Component Number

Cap Comp No.	Cap Drawing No.	Material	AON's (W02-358-)	Page No.
6700	NBD-13938	Aluminum	9902	153
6711	NAD-30942	Plastic	W26-358-9911	154
6713	NAD-30942	Plastic	W26-358-9913	154
6714	NAD-30942	Plastic	W26-358-9912	154
6978	FIP-100102	Plastic	7208	147
6987	NBD-15430	Plastic	7206, 7205, 7215	144, 149, 152
6988	NBD-15305	Aluminum	9000, 9001, 9002	153
6990	NBD-13706	Plastic	7204, 7109	142, 149
6991	NBD-14314	Plastic	7155, 7093	138, 151
6997	NBD-13262	Plastic	7098, 7106, 7074, 7056	139, 142, 145, 146
7005	NBD-9930	Aluminum	7007	142
7007	NBD-10010	Aluminum	7076, 7012, 7017, 7024	139, 145, 148, 150
7009	NBD-10049	Aluminum	4003	148
7013	NBD-10183	Aluminum	7073, 7085, 7037, 7067, 7038, 7043	141, 142, 145, 147, 149, 150
7014	NBD-10082	Aluminum	6754, 7031, 7036	137, 141, 150
7015	NBD-10239	Plastic	7150, 7041, 7040, 7080, 7042, 7044, 7083,	137, 138, 140, 143, 146, 150, 152
7018	NBD-10218	Plastic	7086, 7001, 7201, 7054, 7064, 7082, 7092, 7200, 7110	136, 137, 139, 144, 148, 149, 151, 152
7042	NBD-10409	Plastic	7059, 7058, 7055, 7209, 7070, 7087, 7061, 7045	138, 139, 140, 141, 143, 144, 145, 146
7050	NBD-10604	Plastic	7116	143
7066	NAD-25400	Plastic	9901	141
7068	NBD-10470	Plastic	7046, 7100, 7049, 7149, 7035, 7103, 7032, 7151, 7029, 7108, 7152	136, 138, 140, 143, 144, 146, 147, 148, 151
7074	NBD-11636	Plastic	7079, 7081	136, 151
7526	NBD-14584	Aluminum	W21-760-9011	154

Firestone

Sleeve Index by Piston Component Number

Piston Comp No.	Piston Drawing No.	Material	AON's (w02-358-)	Page No.
6888	NAD-31336	Plastic	W26-358-9913, 9912	154
6890	NAD-30940	Plastic	W26-358-9911	154
6891	NBD-14589	Plastic	7093	151
6894	NBD-14218	Plastic	7109	149
6896	NBD-12708	Plastic	7059, 7058, 7149	138, 139, 140
6897	NBD-13939	Aluminum	9902	153
6979	FIP-100105	Plastic	7209	141
6986	NBD-15431	Plastic	7206, 7205, 7215	144, 149, 152
6996	NBD-13499	Plastic	7155, 6754	137, 138
6998	NBD-12802	Plastic	7070, 7087	143, 144
7023	NBD-10071	Aluminum	7012, 7017, 7024, 7073, 7085, 7067, 7043	141, 142, 145, 147, 148, 150
7033	NBD-10238	Plastic	7208, 7041, 7040, 7080, 7042, 7044, 7083, 7116, 7049, 7032, 7151, 7029, 7081	138, 140, 143, 146, 147, 150, 151, 152
7041	NBD-10215	Plastic	7098, 7074, 7054, 7045	139, 145, 146
7044	NBD-10514	Aluminum	4003	148
7047	NBD-10526	Plastic	7106, 7056, 7110, 7055	140, 142, 146, 152
7049	NBD-10549	Aluminum	7007, 7031	141, 142
7052	NBD-10552	Plastic	7204, 7086, 7001, 7201, 7075, 7064, 7082, 7092, 7200, 7061	136, 137, 142, 144, 145, 148, 149, 151, 152
7054	NBD-10795	Aluminum	7076, 7037, 7038	139, 145, 149
7059	NBD-11340	Plastic	9901	141
7069	NBD-12816	Aluminum	7036	150
7083	NBD-13727	Plastic	7150, 7046, 7100, 7035, 7103, 7108, 7152, 7079	136, 137, 138, 143, 144, 148, 151
7571	NAD-28088	Plastic	W21-760-9011	154
7572	NBD-14048	Aluminum	9000, 9001, 9002	153

Cross References

1T & Convolutd Manufacturer to Firestone Number

Manufacturer Name/ Part Number	Firestone AON	Page No.
AG CHEM		
	W01-358-8092	83
	W01-358-8092	83
AIR AX (Roelofs)		
	W01-358-5323	8
	W01-358-5414	10
	W01-358-9953	16
	W01-358-8977	12
AIR SUSPENDED		
	W01-358-7726	100
AIRGLIDE		
	W01-358-7726	100
200 05/05/03 or later	W01-358-9547	17
200 05/05/03 or later	W01-358-9541	17
200 Before 05/05/03	W01-358-9675	18
380	W01-358-8813	40
400	W01-358-9547	17
460	W01-358-9541	17
690	W01-358-9541	17
ALLISON		
	W01-358-7798	127
	W01-358-8792	88
AMERICAN CARRIER		
	W01-358-7117	100
	W01-358-6902	105
8003-003	W01-358-9421	67
8003-005	W01-358-7146	118
8003-006	W01-358-7325	103
8003-007	W01-358-7105	99
8003-009	W01-358-3400	102
8003-011	W01-358-5412	10
8003-013	W01-358-7093	99
8003-017	W01-358-5328	8
8003-023	W01-358-5766	66

Manufacturer Name/ Part Number	Firestone AON	Page No.
AMERICAN CARRIER cont.		
8003-024	W01-358-5765	66
8003-025 (super-sedes 9234)	W01-358-9290	15
8003-026 (super-sedes 9455-Bellows 1T47A-1) (replaces W01-358-3401 and W01-358-3405)	W01-358-3402	102
9003-001	W01-358-5310	7
ARVIN MERITOR		
202796 (GY 1R13-130)	W01-358-8729	75
202796	W01-358-8617	79
21227742 FS25	W01-358-6262	53
21227892 FS25	W01-358-6258	72
2258-G-1489	W01-358-6392	108
A-2258-A-1457 RPH-11	W01-358-8171	118
A-2258-A-1483 (WCC Front RV)	W01-358-8878	35
A-2258-C-1459	W01-358-8203	34
A2258-E-1461 RHP-55	W01-358-8617	79
A-2258-J-1466 WCC Rear RV	W01-358-9553	15
A-2258-U-1451 RFA23ER-RV	W01-358-9459	22
BINKLEY		
	W01-358-8204	34
XB-SPN-053-37 (Note: supersedes W01-358-7550)	W01-358-7555	117
BROCK		
	W01-358-5772	67
	W01-358-5771	67
CAPACITY OF TEXAS		
	W01-358-5712	13
	W01-358-9402	65
	W01-358-8600	69
	W01-358-6994	98

Firestone

1T & Convolted Manufacturer to Firestone Number

Manufacturer Name/ Part Number	Firestone AON	Page No.
CATERPILLAR		
	W01-358-8235	117
CCG		
	W01-358-9348	62
CHALMERS		
	W01-358-7043	98
	W01-358-7094	100
	W01-358-7185	111
	W01-358-7853	131
(remove bolt) - Suspension should have axle stops-if not-use W01- 358-9245	W01-358-9342	54
CIRCLE R		
	W01-358-5310	7
	W01-358-5405	9
	W01-358-9073	14
	W01-358-5422	10
CITY WELDING		
	W01-358-9149	85
	W01-358-9156	89
	W01-358-9216	82
COLUMBIA TRAILER		
	W01-358-9177	86
	W01-358-9179	86
	W01-358-9152	89
	W01-358-9410	66
	W01-358-6902	105
8003-003	W01-358-9421	67
8003-005	W01-358-7146	118
8003-006	W01-358-7325	103
8003-007	W01-358-7105	99
8003-009	W01-358-3400	102
8003-011	W01-358-5412	10
8003-013	W01-358-7093	99
8003-017	W01-358-5328	8
8003-023	W01-358-5766	66

Manufacturer Name/ Part Number	Firestone AON	Page No.
Custom Chassis		
	W01-358-9505	32
16-16019-000	W01-358-8207	34
DART		
21-4048	W01-358-9135	85
21-40057	W01-358-7244	121
21-40061	W01-358-7294	122
DEXTER AXLE		
034-279-00	W01-358-8886	18
East Mfg.		
	W01-358-9049	14
EVERLY		
	W01-358-9474	50
EZ RIDE		
	W01-358-7146	118
	W01-358-8008	124
	W01-358-7408	113
	W01-358-7838	129
	W01-358-7845	130
8030120	W01-358-6905	105
8030150	W01-358-7447	115
8030160	W01-358-6801	119
8030170	W01-358-7808	128
8030180	W01-358-7818	128
8030190	W01-358-7180	111
8030192	W01-358-9053	36
	W01-358-8600	69
	W01-358-6994	98
FAB TEK		
101357	W01-358-9071	42
04-0080	W01-358-7400	112
101827	W01-358-9039	31
FARGO TRAILER		
	W01-358-7136	117

Cross References

1T & Convoluted Manufacturer to Firestone Number

Manufacturer Name/ Part Number	Firestone AON	Page No.
FIFTH WHEEL		
	W01-358-7726	100
FLEX AIR		
	W01-358-8813	40
FORETRAVEL INC.		
	W01-358-9448	21
FREIGHTLINER		
	W01-358-8207	34
16-10769-000	W01-358-7400	112
16-15444-000 service (no bracket, no piston) --reuse old bracket or purchase sepa- rately (pg.62)	W01-358-9634	39
16-17010- 002A16-18334- 001	WC1-358-3876	74
16-13810-001 (plastic) 9780	WC1-358-3900	74
16-13810- 002 (plastic) (cabover)	WC1-358-3901	74
16-11378-000	W01-358-7410	113
16-13810-000 (plastic)	W01-358-9780	73
16-14263-000	W01-358-9634	39
16-15443-000 (6033 bracket)	W01-358-9634	39
16-1673-000 (steel) See W01-358-9782	W01-358-9780	73
16-16773-000 (steel) - See W01-358-9782	W01-358-9781	73
681-320-0017 (aluminum) See W01-358-9781	W01-358-9780	73
681-320-0017, A16-14004-000 (aluminum)	W01-358-9781	73
A16-14004-000 (aluminum) 9781	WC1-358-3900	74

Manufacturer Name/ Part Number	Firestone AON	Page No.
FREIGHTLINER cont.		
A16-14004-001 (aluminum)	WC1-358-3901	74
16-15443-001 (6034 bracket)		
FREIGHTLINE CUSTOM CHASSIS		
16-15762-000 Ambulance	W01-358-9774	39
16-16773-000 Steel Piston	W01-358-9782	74
16-17315-000 ZF-IFS	W01-358-8632	75
16-17010-00116- 15762-000		
FRUEHAUF		
	W01-358-7409	113
MFR-022355	W01-358-9078	36
MFR 022354		
UCA-0112-B	W01-358-7183	111
UCC-3054-1		
UAB-5620	W01-358-7181	111
UCA-0112	W01-358-7183	111
UCB-44531	W01-358-9077	31
UCB-9668-1	W01-358-9078	36
UCD-9393-2	W01-358-9394	62
UCE-1304-1	W01-358-9096	47
UCE-1304-2	W01-358-9053	36
8030160	W01-358-6801	119
8030170	W01-358-7808	128
8030180	W01-358-7818	128
8030190	W01-358-7180	111
8030192	W01-358-9053	36
	W01-358-8600	69
	W01-358-6994	98
GALLENBERG		
	W01-358-7146	118
	W01-358-7512	121

Firestone

1T & Convuluted Manufacturer to Firestone Number

Manufacturer Name/ Part Number	Firestone AON	Page No.
GENERAL COACH		
	W01-358-5335	11
	W01-358-8977	12
	W01-358-9592	15
GMC		
693230	W01-358-7400	112
711954	W01-358-7401	112
2076095	W01-358-7401	112
Goodyear		
(GY 1R12-204)	W01-358-9566	23
(GY 1R12-205)	W01-358-9568	26
(GY 1R12-324)	W01-358-9565	23
(GY 1R12-325)	W01-358-9567	26
GRANNING		
1014	W01-358-7818	128
1015	W01-358-7140	118
1080	W01-358-7113	98
1218 (replaces 7416)	W01-358-7443	114
1359	W01-358-9083	46
1371	W01-358-6910	104
1476	W01-358-7816	128
1613	W01-358-7798	127
1626	W01-358-7136	117
1971	W01-358-5406	9
2112	W01-358-5410	10
2279	W01-358-7118	118
2577	W01-358-9210	48
2598	W01-358-9214	90
2692	W01-358-9211	48
2725	W01-358-7403	112
2726	W01-358-7400	112
2727 (super-sedes 9298)	W01-358-9342	54
3750	W01-358-9388	50
4514	W01-358-7800	128
4848	W01-358-6902	105
5065	W01-358-9105	37

Manufacturer Name/ Part Number	Firestone AON	Page No.
GRANNING cont.		
5122	W01-358-2119	7
5235	W01-358-5423	10
5301	W01-358-8977	12
5307 (no stud)	W01-358-5423	10
5385 (no stud)	W01-358-8922	24
5492	W01-358-8922	24
5553	W01-358-8979	12
5691	W01-358-2120	7
6057	W01-358-8965	16
6104 (no stud)	W01-358-2120	7
6117	W01-358-5426	13
6250	W01-358-9478	11
6252	W01-358-9049	14
6978	W01-358-8958	22
7025	W01-358-6960	110
7026	W01-358-7855	131
7504	W01-358-5323	8
7593	W01-358-8760	81
7692	W01-358-8918	24
7765	W01-358-5434	11
7831	W01-358-5436	11
7901 (replaced W01-681-8770) [1T19F-7]	W01-358-8735	79
8221	W01-358-7996	123
8273	W01-358-9825	87
8609	W01-358-5702	13
HAGIE		
	W01-358-8810	40
	W01-358-9439	25
HENDRICKSON TRUCK		
	W01-358-9113	37
	W01-358-7180	111
1347	W01-358-7505	103
28929	W01-358-8708	80
45843-2	W01-358-7279	102
48195-2	W01-358-9223	48

Cross References

1T & Convolute Manufacturer to Firestone Number

Manufacturer Name/ Part Number	Firestone AON	Page No.
HENDRICKSON TRUCK cont.		
48195-1 (b.plate studs-1.350) (2 studs in piston at 90i alignment)	W01-358-9227	49
49048 (Ford)	W01-358-9466	52
49160-0Ê	W01-358-9256	49
49207 (Marmon)	W01-358-9466	52
49674-1&2 (Mack) (57QL411M)	W01-358-9466	52
50405-1&2 (Ford, W.Star) HA-360/400/460 [1991-Up]	W01-358-9287	56
50898-1 & 2 (GH & Ford) (class 6, 7 & 8)	W01-358-9297	57
50899-1 & 2 (Mack-class 8) 57QL414M	W01-358-9375	57
56808-2 (class 6 Ford)	W01-358-9339	38
56916 (class 6 Freightliner) -not current production - ref 56917 (W01-358-9335)	W01-358-9284	24
56917-1 & 2 (Class 6 & 7 Freightliner) - -ref.56916 (W01-358-9284) -super-seded	W01-358-9335	43
57122-2 (Ford, class 8)	W01-358-9373	57
57140 LH - Remove new bracket and reuse old (class 6 & 7 GM)	W01-358-9339	38
57150 RH	W01-358-9339	38

Manufacturer Name/ Part Number	Firestone AON	Page No.
HENDRICKSON TRUCK cont.		
57920-2 w/bracket	W01-358-8868	12
57965-2 (reuse old bracket)	W01-358-8868	12
58520-2 (Nissan) (replaces 58654-2)	W01-358-9372	57
58786-2	W01-358-9647	58
58983-2 (Blue Bird)	W01-358-8942	25
58995-2 (Freightliner)	W01-358-9643	52
59053-2	W01-M58-6260	53
59055-2 - (HAD 150 & 190) replaces 58817-2 RVI/US	W01-M58-9642	58
59319-2	W01-M58-8712	80
59484-2 (Blue Bird)	W01-358-8971	29
59601-2	W01-358-8972	29
60716-2	W01-358-9554	23
60925-2	W01-358-8817	41
60929-2	W01-358-8816	40
64403-2	W01-M58-8650	35
64827-2	W01-358-8872	8
65032-2	W01-358-9654	58
60271-2	W01-358-9663	59
64489-2	W01-358-9372	57
64651-2	W01-358-9297	57
64651-2	W01-M58-9656	59
65790-2	W01-358-8597	19
HENDRICKSON AUX.		
(Paralift, Paralift Ultra)	W01-358-7795	107
(Pararev)	W01-358-7897	108
1015	W01-358-8042	127
1285	W01-358-7859	131

Firestone

1T & Convoluted Manufacturer to Firestone Number

Manufacturer Name/ Part Number	Firestone AON	Page No.
HENDRICKSON AUX. cont.		
1346	W01-358-7797	127
1475	W01-358-7790	116
1503	W01-358-6789	114
1560	W01-358-7998	123
2348	W01-358-7954	126
4647	W01-358-3420	102
4828	W01-358-7872	132
001795 (Paralift Ultra/High Lift) -ride bag	W01-358-7862	131
001796 (Paralift Ultra/High Lift) -lift bag	W01-358-7545	116
002878 (Lift Bag)	W01-358-7897	108
003316 (metric version)	W01-358-8033	126
003316 (metric version)	W01-358-8033	126
003317 (metric version)	W01-358-7795	107
003318 (metric version)	W01-358-6935	106
003319 (metric equivalent)	W01-358-9367	64
003319 (Same as SAE version W01-358-9367)	W01-358-9668	65
003319 (metric equivalent)	W01-358-9367	64
HENDRICKSON CANADA		
B-12514-001	W01-358-7403	112
B-12514-003	W01-358-9302	37
B-12514-013	W01-358-8051	94
B-12514-014	W01-358-7135	117
B-12514-004, B-12514-011	W01-358-9158	89
B-12514-005	W01-358-7472	116
B12514-012	W01-358-8052	94
S10352	W01-358-9240	61
S12353	W01-358-9092	47

Manufacturer Name/ Part Number	Firestone AON	Page No.
HENDRICKSON CANADA cont.		
S2066, S11651, B-12514-007	W01-358-9082	46
B-3411	W01-358-9228	49
45843-1	W01-358-6905	105
45843-3	W01-358-6910	104
B-12514-008, B-12514-010	W01-358-9122	88
HENDRICKSON TRAILER		
Prototype C21623	W01-358-8755	76
Prototype C21624	W01-358-8756	76
C20413 (rotate piston to 45i alignment)	W01-358-9265	63
HT-250T	W01-358-9265	63
HT-250U (all others)	W01-358-9265	63
HT-250U-Y (9Y-001)	W01-358-9265	63
S1013	W01-358-7400	112
S1080	W01-358-7136	117
S1159	W01-358-7403	112
S11566 (remove bolt)	W01-358-9010	41
S11637	W01-358-8008	124
S12405	W01-358-8032	125
S1245	W01-358-9105	37
S13122 [HT250U(9-020)]	W01-358-9264	92
S14147	W01-358-9652	16
S14147	W01-358-9043	13
S14249 (W01-455-9321)	W01-358-9367	64
S14318	W01-358-6935	106
S14486 (lift bag)	W01-358-7795	107
S14487 (Ride Bag) [Paralift Ultra] [Pararev]	W01-358-8033	126
S14795	W01-358-8043	127
S1561	W01-358-9083	46
S20010 (HT230T)	W01-358-9270	70

Cross References

1T & Convoluted Manufacturer to Firestone Number

Manufacturer Name/ Part Number	Firestone AON	Page No.
HENDRICKSON TRAILER cont.		
S20124	W01-358-9265	63
S20127 [HT-250U 9-006] [HT-250UY 9Y-006] replaces 1T15VLT-10.5 1T15V-11 W01-358-9262	W01-358-9580	80
S20157	W01-358-9928	92
S20217 (HT-190U) - superseded by W01-358-8944 1T15MLW-7	W01-358-9015	27
S20217 (HT-190U) - supersedes W01-358-9015	W01-358-8944	52
S20223 (HT-190T, HS-190T) - replaces W01-358-9630	W01-358-9640	39
S20228	W01-358-8934	36
S20414 [HT-250U (9-006)] [HT-250U-Y (9Y-006)] Replaces 1T15VLT-10.5 1T15V-11	W01-358-9581	81
S2063	W01-358-9158	89
S2064/S11650	W01-358-9039	31
S2065	W01-358-9177	86
20716	W01-358-9299	52
S20900 (Intraax AA230) [Up to 7/97] -replaced by W01-358-8709 (approx. 6/98) 1T17CA-5	W01-358-8751	76
S20901 (Intraax 250) -reuse metal disk	W01-358-8091	83
S21208	W01-358-9579	70
S21323	W01-358-6962	110

Manufacturer Name/ Part Number	Firestone AON	Page No.
HENDRICKSON TRUCK cont.		
S21784 w/metal disk for piston support	W01-358-8091	83
S21800 (Intraax AA230) [8/97-up] -replaces W01-358-8751 (approx. 6/98)	W01-358-8709	79
S21966 (HKA200 Special)	W01-358-8708	80
S22045 (HK190T)	W01-358-8755	76
S22046 (HK230) Approximate availability 1-98 - -replaces W01-358-8756	W01-358-8710	79
S22046 (HK230) -will be replaced by W01-358-8710 1T17CL-5	W01-358-8756	76
S22173	W01-358-5511	91
S22697	W01-358-8724	78
S22948 (Van Traax) - Prior to 9/99- used 9525 piston w/bumper spacer	W01-358-8713	80
S2307	W01-358-9011	41
S23114	W01-358-7897	108
S23611	W01-358-9646	63
S23612	W01-358-9645	65
S23613	W01-358-9621	28
S23614	W01-358-9619	28
S23720	W01-358-9626	27
S23721	W01-358-9644	51
S23748 (w/disk S24443)	W01-358-8093	87
S2394	W01-358-2119	7
S25873	W01-358-8774	84
S2630	W01-358-6902	105

Firestone

1T & Convuluted Manufacturer to Firestone Number

Manufacturer Name/ Part Number	Firestone AON	Page No.
HENDRICKSON TRUCK cont.		
S26773	W01-358-8614	79
S2694	W01-358-9203	60
S27031	W01-358-8623	80
S2734	W01-358-6801	119
S2827	W01-358-9010	41
S2883	W01-358-7403	112
S2924	W01-358-9227	49
S3184	W01-358-7140	118
S3467, S3830	W01-358-9122	88
S3518	W01-358-6905	105
S3648	W01-358-9215	82
S3798	W01-358-7446	115
S3839	W01-358-9200	82
S3842	W01-358-9240	61
S4771	W01-358-8050	93
S4773	W01-358-9392	50
S5060	W01-358-9238	61
S5270	W01-358-6905	105
S5468	W01-358-7404	112
S6195	W01-358-9192	60
S6242	W01-358-7447	115
S6412	W01-358-6803	119
S6861	W01-358-7839	129
S7100	W01-358-7843	129
S7128	W01-358-9156	89
S7193	W01-358-9073	14
S7364	W01-358-9285	14
S7853	W01-358-7846	130
S8701	W01-358-6947	110
S8768	W01-358-6910	104
S8832	W01-358-5310	7
S8874	W01-358-7847	130
S8988	W01-358-9349	62
S9346	W01-358-5405	9
S9830	W01-358-7444	115
HISTEER		
	W01-358-8018	125
	W01-358-8008	124

Manufacturer Name/ Part Number	Firestone AON	Page No.
HISTEER cont.		
(supercedes 8029)	W01-358-8027	125
10300	W01-358-7839	129
10301	W01-358-7850	131
10302	W01-358-6941	106
10303	W01-358-8039	126
10305	W01-358-6940	106
10307	W01-358-6944	109
10313	W01-358-8038	126
10315	W01-358-7550	116
10316	W01-358-7557	120
HLM LIFT BAG		
	W01-358-6935	106
HOLLAND (NEWAY)		
(AD-123/246-10) 90557146 90557182 (no bracket) 90557177 (special lower connection)	W01-358-9471	71
(replaced by 6799)	W01-358-6808	120
90044197	W01-358-9158	89
90044201	W01-358-9101	60
900557112 (AR90-[All]) (ARU92-9&10)	W01-358-9243	61
90557001	W01-358-9039	31
90557001	W01-358-7135	117
90557002	W01-358-7009	98
90557003	W01-358-9177	86
90557005	W01-358-9158	89
90557006, 90557027, 90557033 (special mounting), 90557037, 90557054, 90557075	W01-358-9082	46
90557007	W01-358-9093	47
90557008	W01-358-9101	60
90557009	W01-358-9101	60
90557012	W01-358-9033	30

Cross References

1T & Convolutd Manufacturer to Firestone Number

Manufacturer Name/ Part Number	Firestone AON	Page No.
HOLLAND (NEWAY) cont.		
90557014 (AL-41 & 45)	W01-358-7424	114
90557015	W01-358-7437	114
90557016	W01-358-7400	112
90557019	W01-358-9121	84
90557020, 90557071, 90557076, 90557077	W01-358-9122	88
90557023	W01-358-9039	31
90557028	W01-358-7112	100
90557030	W01-358-9075	20
90557031	W01-358-9092	47
90557032	W01-358-9093	47
90557034 90557029	W01-358-8997	9
90557035	W01-358-9093	47
90557038	W01-358-9070	42
90557039	W01-358-7146	118
90557052	W01-358-9121	84
90557057	W01-358-5412	10
90557069	W01-358-9158	89
90557078	W01-358-9121	84
90557082	W01-358-9101	60
90557083	W01-358-9121	84
90557085	W01-358-9039	31
90557086	W01-358-9192	60
90557089 (remove bolt)	W01-358-9308	31
90557090 (AR-90-1-12)	W01-358-9070	42
90557094 (ARD suspensions) - reference 90557128 (bead plate-3215)	W01-358-9599	16
90557097	W01-358-9650	66
90557098 (ARDTB125-6A&6B)	W01-358-8053	94

Manufacturer Name/ Part Number	Firestone AON	Page No.
HOLLAND (NEWAY) cont.		
90557099	W01-358-9320	63
90557101	W01-358-9193	47
90557102	W01-358-5511	91
90557103	W01-358-5505	90
90557104	W01-358-9915	92
90557104	W01-358-9264	92
90557105 (GM-U-Haul)	W01-358-9798	45
90557106	W01-358-9929	92
90557107	W01-358-9249	69
90557108 (AR-90)	W01-358-9192	60
90557110 (parallel alignment)	W01-358-9121	84
90557111 (AR-80-9FM)	W01-358-9138	88
90557113 (AR90-1-14&17) (AR75-6&9)	W01-358-9362	50
90557117 (AR92-12&14), (AR93-14)	W01-358-9921	54
90557118 (AR92&93-15&16)	W01-358-9923	54
90557119 (AR92-17) (AR93-17)	W01-358-9922	54
90557120 (RL196-14, RL196A-14)	W01-358-9293	27
90557121 (RL196-15 & 16) (RL196A-15 & 16)	W01-358-9295	27
90557123 - Service assembly only (no piston)	W01-358-9268	38
90557124 (AR-90115 & 16)	W01-358-9304	49
90557125 (AR-80-9) (AR-80-9WST)	W01-358-9134	88
90557126 (AR-75-12) (AR-75-1-12) (ARU92-12)	W01-358-9346	61
90557127 (RL-196-12)	W01-358-9294	27

Firestone

1T & Convolted Manufacturer to Firestone Number

Manufacturer Name/ Part Number	Firestone AON	Page No.
HOLLAND (NEWAY) cont.		
90557128	W01-358-9599	16
90557129 (AR-41, 45 & 45-1) (plastic)	W01-358-9307	33
90557130-RH	W01-358-9463	43
90557131-LH	W01-358-9463	43
90557137 (only 2 studs in piston and 90i alignment)	W01-358-9798	45
90557138	W01-358-9902	54
90557139 (RL196-17) (RL196A-17) - replaces 90557122 -originally 1T15M-4 bellows	W01-358-9291	26
90557142	W01-358-9942	55
90557143	W01-358-9943	55
90557145 (AD-246)	W01-358-9470	71
90557147 (AD-123/246-6.5 & 8.75)	W01-358-9472	71
90557149	W01-358-9325	37
90557150	W01-358-8949	26
90557152	W01-358-9473	71
90557155	W01-358-9144	85
90557156 (RL-228-14,15,16)	W01-358-9936	55
90557157 (RL-228-17)	W01-358-9935	55
90557158	W01-358-9484	44
90557159	W01-358-9365	38
90557160	W01-358-9366	38
90557161 (AD200-7) (Gillig) - ref. W01-358-9585 (1/2"ONPT)	W01-358-9482	43
90557162	W01-358-8780	87

Manufacturer Name/ Part Number	Firestone AON	Page No.
HOLLAND (NEWAY) cont.		
90557163	W01-358-8779	87
90557164	W01-358-8778	84
90557166 (AD200-8) (Gillig)	W01-358-9483	44
90557167 (AR250-14 & 15)	W01-358-8748	77
90557168 (AR250-12,16,17)	W01-358-8749	77
90557169 (Advance Mixer)	W01-358-8903	53
90557170	W01-358-8802	39
90557172 (AD-200) - ref. 90557220 90557248 (1/2"ONPT)	W01-358-9597	16
90557173 (RL196A-12)	W01-358-8204	34
90557174 (AS 120)	W01-358-5776	68
90557179 (no bracket)	W01-358-9473	71
90557185 (parallel align.)	W01-358-9122	88
90557194 (Dock-Mate)	W01-358-8803	39
90557200	W01-358-5503	90
90557203	W01-358-6799	120
90557205	W01-358-8781	87
90557206	W01-358-9491	72
90557208	W01-358-9496	50
90557209	W01-358-9218	83
90557210 - (replaces W01-358-8987)	W01-358-8203	34
90557210	W01-358-9366	38
90557211 (2 bolt mounting on piston)	W01-358-9470	71
90557212 (146)	W01-358-9471	71
90557214 (182) (2 bolt mounting on piston)	W01-358-9471	71

Cross References

1T & Convoluted Manufacturer to Firestone Number

Manufacturer Name/ Part Number	Firestone AON	Page No.
HOLLAND (NEWAY) cont.		
90557215 (152)	W01-358-9473	71
90557216 (179) (2 bolt mounting on piston)	W01-358-9473	71
90557218	W01-358-9891	91
90557221 (1/2" NPT-flush)	W01-358-9586	69
90557223	W01-358-8204	34
90557225	W01-358-9366	38
90557226	W01-358-7008	98
90557227	W01-358-9948	56
90557228	W01-358-6890	103
90557229 (IFS-114) - (center stud used for locating in pre-assembly)	W01-358-8198	34
90557230	W01-358-8197	33
90557232	W01-358-9578	70
90557233	W01-M58-6317	53
90557235	W01-358-8746	77
90557236	W01-358-8042	127
90557237	W01-358-6943	109
90557240	W01-358-9582	70
90557243	W01-358-8744	77
90557247 (replaces 90557219-flush fitting) - ref. W01-358-9482	W01-358-9585	44
90557248 (replaces 90557220-1/2" NPT flush) - ref. W01-358-9597	W01-358-9587	15
90557249 replaces	W01-358-9586	69
90557252	W01-358-9649	58
90557256 IFS-114	W01-358-7667	33

Manufacturer Name/ Part Number	Firestone AON	Page No.
HOLLAND (NEWAY) cont.		
90557270 AD-130	W01-358-8793	91
90557271 (NSH225, NSB225, RLU250)	W01-358-8738	78
90557272 (NS225, NS450, WN225, NSH450)	W01-358-8737	78
90557283 RL300	W01-358-8796	88
90557295 (RL230, GRL228)	W01-358-9971	56
90557300	W01-358-9936	55
90557301	W01-358-9935	55
90557302 RL230	W01-358-9972	56
90557312	W01-358-9505	32
90557313	W01-358-9507	44
90557211 RE-PLACEMENT PISTON COMES WITHOUT STUDS	W01-358-9502	72
90557214 RE-PLACEMENT PISTON COMES WITHOUT STUDS	W01-358-9501	72
90557216	W01-358-9504	72
90557260	W01-358-8764	90
90557306	W01-358-8882	32
90557308 (Same except piston Stud length 1.5 W01-358-8182)	W01-358-8184	17
90557314	W01-358-8676	75
90557329	W01-358-9697	44
90557332	W01-358-9974	56
90557354	W01-358-9855	26
90557144	W01-358-9896	92
90557250 (replaces W01-675-9613, 90557224-flush fitting)	W01-358-9584	19
90557290 (RL228, KL230)	W01-358-8184	17

Firestone

1T & Convolted Manufacturer to Firestone Number

Manufacturer Name/ Part Number	Firestone AON	Page No.
HOLLAND (NEWAY) cont.		
Use with Neway CB-4000 W01-358-9807	WC1-358-1690	32
Use with Neway CB-4000 W01-358-9807	WC1-358-1691	33
Use with Neway CB-4000 W01-358-9807	WC1-358-1692	33
HOLLAND HITCH		
4514	W01-358-7800	128
6764	W01-358-7304	133
6788	W01-358-7230	122
Hutchens		
H-2007	W01-358-9075	20
H-10384-01	W01-358-7405	112
H-1913-1	W01-358-9059	41
H-9424-01	W01-358-9039	31
H-9630-01		
H-19141-01	W01-358-5766	66
INTEGRATED		
	W01-358-7424	114
JET CO.		
(10.30 max. OD) Bolt removed for center mounting	W01-358-9260	65
(replace 9255) (11.00 max. OD) Bolt removed for center mounting	W01-358-9259	14
	W01-358-5408	9
JOHN DEERE		
	W01-358-8931	35
AH160823	W01-358-5336	12
AN205761	W01-M58-8798	83
AW30683	W01-358-6831	101

Manufacturer Name/ Part Number	Firestone AON	Page No.
KELDERMAN		
	W01-358-2131	7
	W01-358-9082	46
KENWORTH		
	W01-358-5773	68
C81-1003	W01-358-8813	40
C81-1004	W01-358-9547	17
C81-1005	W01-358-9541	17
K-102-A	W01-358-9073	14
K303-14	W01-358-9422	18
K303-15 (Airglide 100) -older version with no bracket	W01-358-9422	18
K-303-18(Airglide 200) - small air fitting - original design (1996 & 1997 prod.) - replaced by K - 303-22(9622)	W01-358-9617	17
K-303-19 (Airglide 200) 46,000# - small air fitting - -1996 & 97 prod. - replaced by K-303-25(9625)	W01-358-9618	18
K-303-22 (Airglide 200-1998 to 5-5-03) - (large air fitting with interconnected airsprings)	W01-358-9622	17
K-303-25 (Airglide 200-46,000#,1998 & later prod.)	W01-358-9625	18
K-303-28	W01-358-9675	18
K-303-5	W01-358-9415	25
K303-6	W01-358-9422	18
KWIK LOK/TODCO (JIFFLOX)		
CP-5125	W01-358-9082	46
53671 (supersedes 7133)	W01-358-7123	117
	W01-358-7180	111
CP-5223	W01-358-7429	114

Cross References

1T & Convoluted Manufacturer to Firestone Number

Manufacturer Name/ Part Number	Firestone AON	Page No.
Link		
1103-0019	W01-358-6884	105
(see 5789)	W01-358-5772	67
1103-0058	W01-358-8842	59
1103-0059	W01-358-5900	108
1103-0500	W01-358-5439	12
1103-0501 Liftable	W01-358-9562	22
1103-0503 Ultraride	W01-358-5789	68
1103-0508	W01-358-9681	23
Load Air P10-755C		
	W01-358-7344	111
P-10872-A	W01-358-6949	107
P60733	W01-358-9221	86
LOAD SHARE		
	W01-358-7462	101
	W01-358-6926	104
LONGER STROKE		
8008	W01-358-8038	126
MCCULLOUGH TRAILER		
	W01-358-9348	62
MACK		
227QS-32 & 57QK1113	W01-358-7325	103
3645Q27 57QL414M	W01-358-9375	57
57QL1115	W01-358-9652	16
57QL1115	W01-358-9043	13
57QL239	W01-358-7145	118
57QL417M)	W01-358-9647	58
MADSEN		
(replaces 9014)	W01-358-9440	21
MAURICE WELDING		
	W01-358-7927	119
MODERN FLOW EQUIPMENT		
	W01-358-7146	118
	W01-358-7852	128

Manufacturer Name/ Part Number	Firestone AON	Page No.
MONACO COACH		
	W01-358-6905	105
W01-358-8897 with 3/4 NPT	W01-358-9376	20
1806160	W01-358-9651	66
8618	W01-358-5319	8
8619	W01-358-9376	20
NAVISTAR		
	W01-358-9068	42
(U-Haul) 1660694C-1	W01-358-9379	24
1660581C-1	W01-358-9213	48
1670073C-1	W01-358-9371	57
1672401C1	W01-358-9566	23
1675495C1	W01-358-9568	26
1686386C-1	W01-358-9371	57
2027911C-1	W01-358-9371	57
2027911C1 & C2	W01-358-9648	58
2027912C1	W01-358-9565	23
2027913C1	W01-358-9567	26
350243C-94	W01-358-9098	52
359519C-1	W01-358-9063	42
426212C-1	W01-358-9098	52
426213C-1	W01-358-9097	51
442305C-91	W01-358-9098	52
442306C-91	W01-358-9098	52
442307C-91	W01-358-9097	51
454590C-1	W01-358-9098	52
454588C-91	W01-358-9098	52
4545889C-1	W01-358-9097	51
4545910C-1	W01-358-9097	51
501559C-1	W01-358-9213	48
501559C-2	W01-358-9213	48
NEWLITE (NS 190-16)		
	W01-358-8204	34
OSHKOSH		
RX-08-03	W01-358-9269	73
	W01-358-5412	10
(ref.8013)	W01-358-8010	124

Firestone

1T & Convolted Manufacturer to Firestone Number

Manufacturer Name/ Part Number	Firestone AON	Page No.
OTTAWA		
53500516	W01-358-7304	133
PEERLESS		
	W01-358-9158	89
	W01-358-9290	15
0550-00001	W01-358-7180	111
0550-00010	W01-358-9149	85
0550-00015	W01-358-7103	99
0550-00051	W01-358-9031	30
0550-00070	W01-358-9148	85
0550-00080	W01-358-9156	89
Peterbilt		
03-10042	W01-358-9069	42
03-01649	W01-358-9069	42
03-01686	W01-358-9589	15
03-02038 (Air-Trac)	W01-358-9069	42
03-02456	W01-358-9069	42
03-04759	W01-358-9069	42
03-05107	W01-358-9194	47
03-06213	W01-358-9026	46
03-06746		
03-07111 (Low Air Leaf)	W01-358-9026	46
03-07112	W01-358-9069	42
03-08424 - replaces W01-358-9146 (1T15S-6)	W01-358-9589	15
03-07887 (Low Air Leaf)	W01-358-8852	59
03-08716 (New Low Leaf Supercedes 03-07887 effective 04/04)	W01-358-8864	60
C81-6000	W01-358-8813	40
PEZZANI		
	W01-358-9075	20
	W01-358-9076	14
	W01-358-9116	84
	W01-358-9199	89

Manufacturer Name/ Part Number	Firestone AON	Page No.
PEZZANI cont.		
AR-21-A	W01-358-7135	117
PIONEER TRAILER		
	W01-358-9071	42
POLLARD		
	W01-358-7230	122
	W01-358-7304	133
PORCUPINE		
	W01-358-9158	89
	W01-358-9122	88
	W01-358-7424	114
	W01-358-7852	128
(replaces 7140)	W01-358-7782	120
(replaces 7142)	W01-358-7140	118
(replaces 7818)	W01-358-7839	129
R & S TRUCK & BODY		
	W01-358-7798	127
1027505	W01-358-6902	105
1027519	W01-358-7400	112
1027556	W01-358-7136	117
1040201	W01-358-7403	112
1082914	W01-358-7446	115
1090023	W01-358-9121	84
1090214	W01-358-7140	118
1090215	W01-358-7424	114
1090216	W01-358-9177	86
1090217	W01-358-9082	46
1090218	W01-358-9039	31
1090326	W01-358-9164	85
RAVENS TRAILER		
	W01-358-9204	82
REYCO		
12882-01	W01-358-9082	46
12882-02	W01-358-9121	84
12883-01	W01-358-9101	60
12883-02	W01-358-9122	88
12884-01	W01-358-9223	48

Cross References

1T & Convoluted Manufacturer to Firestone Number

Manufacturer Name/ Part Number	Firestone AON	Page No.
REYCO cont.		
12884-01A (102AR)	W01-358-9223	48
12884-01B	W01-358-9944	51
12906-01	W01-358-6927	109
12928-01	W01-358-9010	41
17360-01	W01-358-9308	31
17361-01	W01-358-8900	19
17414-01	W01-358-8991	36
17636-01	W01-358-9349	62
19624-01	W01-358-8951	25
19983-01 (21AR, 74AR)	W01-358-7557	120
20018-01 (86AR)	W01-358-7555	117
20074-01	W01-358-9332	31
20124-01	W01-358-9966	51
20124-01K (1/4 NPT) - [Use 1/2 to 1/4 NPT adaptor]	W01-358-9966	51
20124-02 (1/2 NPT)	W01-358-9966	51
20142-01 & 01K	W01-358-9947	55
20437-01	W01-358-9333	31
20446-01	W01-358-9476	22
20773-01	W01-358-8959	23
20783-01	W01-358-5775	68
20966-01	W01-358-9474	50
21054-01	W01-358-9377	20
21055-01	W01-358-8976	29
21598-01	W01-358-8964	29
21767-01	W01-358-8776	84
22241-01	W01-358-8932	35
22425-01	W01-358-5777	68
23377-01	W01-358-8961	28
23433-01	W01-358-8740	75
23521-01	W01-358-8855	59
23521-02	W01-358-8856	60
24894-02	W01-358-9690	51
25396-01	W01-358-9560	28

Manufacturer Name/ Part Number	Firestone AON	Page No.
REYCO cont.		
24556-01	W01-358-9277	83
25437-01	W01-358-9559	28
93AR	W01-358-8018	125
RIDE SENTRY		
	W01-358-8617	79
RIDEWELL		
	W01-358-7839	129
	W01-358-6900	104
1001R13109G	W01-358-8782	77
1003585310C	W01-358-5310	7
1003585311C	W01-358-5311	7
1003585323C	W01-358-5323	8
1003585410C	W01-358-5410	10
1003585414C	W01-358-5414	10
1003585770C	W01-358-5770	67
1003585792C	W01-358-5792	69
1003586801C	W01-358-6801	119
1003586805C	W01-358-6805	119
1003586817C	W01-358-6817	109
1003586902C	W01-358-6902	105
1003586905C	W01-358-6905	105
1003586910C	W01-358-6910	104
1003586932C	W01-358-6932	106
1003586945C	W01-358-6945	109
1003586946C	W01-358-6946	110
1003586947C	W01-358-6947	110
1003586948C	W01-358-6948	110
1003587112C	W01-358-7112	100
1003587135C	W01-358-7135	117
1003587136C	W01-358-7136	117
1003587140C	W01-358-7140	118
1003587145C	W01-358-7145	118
1003587146C	W01-358-7146	118
1003587180C	W01-358-7180	111
1003587271C	W01-358-7271	121
1003587273C	W01-358-7273	122
1003587274C	W01-358-7274	132

Firestone

1T & Convuluted Manufacturer to Firestone Number

Manufacturer Name/ Part Number	Firestone AON	Page No.
RIDEWELL cont.		
1003587275C	W01-358-7275	122
1003587286C	W01-358-7286	132
1003587330	W01-358-7330	103
1003587400C	W01-358-7400	112
1003587403C	W01-358-7403	112
1003587406C	W01-358-7406	113
1003587437C	W01-358-7437	114
1003587443C	W01-358-7443	114
1003587473C	W01-358-7473	115
1003587483C	W01-358-7483	115
1003587781C	W01-358-7781	120
1003587796C	W01-358-7796	127
1003587800C	W01-358-7800	128
1003587808C	W01-358-7808	128
1003587818C	W01-358-7818	128
1003587844C	W01-358-7844	129
1003587893C	W01-358-7892	107
1003588008C	W01-358-8008	124
1003588010C	W01-358-8010	124
1003588014C	W01-358-8014	124
1003588016C	W01-358-8016	124
1003588030C	W01-358-8030	125
1003588051C	W01-358-8051	94
1003588055C	W01-358-8055	93
1003588088C	W01-358-8088	81
1003588201C	W01-358-8201	34
1003588752C	W01-358-8752	76
1003588753C	W01-358-8753	76
1003589053C	W01-358-9053	36
1003588802C	W01-358-8802	39
1003588803C	W01-358-8803	39
1003588805C	W01-358-8805	40
1003588806C	W01-358-8806	40
1003588919C	W01-358-8919	24
1003588924C	W01-358-8924	45
1003588930C	W01-358-8930	35
1003588963C	W01-358-8963	29

Manufacturer Name/ Part Number	Firestone AON	Page No.
RIDEWELL cont.		
1003588986C	W01-358-8986	30
1003588992C	W01-358-8992	9
1003588997C	W01-358-8997	9
1003589008C	W01-358-9008	41
1003589010C (re-places 9064)	W01-358-9010	41
1003589029C	W01-358-9029	30
1013589039C	W01-358-9039	31
1003589071C	W01-358-9071	42
1003589073C	W01-358-9073	14
1003589082C	W01-358-9082	46
1003589083C	W01-358-9083	46
1003589101C	W01-358-9101	60
1003589105C	W01-358-9105	37
1003589118C	W01-358-9118	37
1003589121C	W01-358-9121	84
1003589122C	W01-358-9122	88
1003589158C	W01-358-9158	89
1003589177C	W01-358-9177	86
1003589200C	W01-358-9200	82
1003589201C	W01-358-9201	89
1003589218C	W01-358-9218	83
1003589245C	W01-358-9245	61
1003589250C	W01-358-9250	73
1003589251C	W01-358-9251	69
1003589252C	W01-358-9252	73
1003589274C	W01-358-9274	70
1003589275C	W01-358-9275	71
1003589277C	W01-358-9277	83
1003589290C	W01-358-9290	15
1003589334C	W01-358-9334	32
1003589368C	W01-358-9368	64
1003589378C	W01-358-9378	20
1003589387C	W01-358-9387	20
1003589423C	W01-358-9423	67
1003589445C	W01-358-9445	21

Cross References

1T & Convoluted Manufacturer to Firestone Number

Manufacturer Name/ Part Number	Firestone AON	Page No.
RIDEWELL cont.		
1003589447C	W01-358-9447	21
1003589448C	W01-358-9448	21
1003589457C	W01-358-9457	21
1003589459C	W01-358-9459	22
1003589467C	W01-358-9467	43
1003589477C	W01-358-9477	22
1003589538C	W01-358-9538	64
1003589797C	W01-358-9797	45
1003589961C	W01-358-9961	86
1003588901C	W01-358-8901	19
RIMPULL		
	W01-358-7226	122
ROCKWELL		
	W01-358-8911	65
ROWE RV		
ASC1000/AS-C1001ASC1002/ASC1003 Spartan	W01-358-8500	82
ASC1000/ASC1001/ASC1002/ASC1003 Spartan	W01-358-9218	83
ROWE TRAILER		
ASCT1500/ASCST1500/ASCST2000	W01-358-5423	10
ASCST2000	W01-358-2120	7
ASCT2500	W01-358-8888	53
ROWE TRUCK		
0035 ASC2500 ASC1600	W01-358-7686	107
0059 ASC 1500	W01-358-7956	126
ASC1400HL Lift	W01-358-2119	7
ASC1400HL Ride	W01-358-8984	94
AS-C1500ASCS1500/ASCS2000 Lift	W01-358-5423	10
ASC2500/AS-C2500ROS Ride	W01-358-8888	53
ASCC2000 Ride	W01-358-9811	86
ASCS2000 Lift	W01-358-2120	7

Manufacturer Name/ Part Number	Firestone AON	Page No.
SAUER		
P10-754	W01-358-7325	103
P10-755	W01-358-7424	114
P10-784	W01-358-7423	113
P10-794	W01-358-7057	101
P20-706	W01-358-3406	102
P10-755C		
P50-732	W01-358-9122	88
P50-733	W01-358-9121	84
P50-734	W01-358-9039	31
SILENT DRIVE		
	W01-358-9082	46
	W01-358-9101	60
	W01-358-7839	129
	W01-358-6905	105
	W01-358-8997	9
	W01-358-7135	117
	W01-358-8008	124
	W01-358-7800	128
	W01-358-9070	42
	W01-358-9921	54
	W01-358-7447	115
	W01-358-8027	125
	W01-358-8038	126
	W01-358-5429	13
	W01-358-9338	64
	W01-358-7344	111
	W01-358-9320	63
	W01-358-7429	114
	W01-358-6948	110
	W01-358-9250	73
(replaces W01-358-8028)	W01-358-8025	125
SUPERIOR		
	W01-358-7839	129
	W01-358-7818	128
	W01-358-7848	130
	W01-358-8006	124

Firestone

1T & Convoluted Manufacturer to Firestone Number

Manufacturer Name/ Part Number	Firestone AON	Page No.
SUPERIOR cont.		
	W01-358-7761	132
	W01-358-7816	128
	W01-358-7286	132
	W01-358-7915	132
SUSPENSION DYNAMICS		
55015	W01-358-9249	69
SUSPENSION INC.		
	W01-358-9218	83
	W01-358-8018	125
	W01-358-5509	91
	W01-358-7499	116
	W01-358-7794	121
	W01-358-6944	109
	W01-358-7405	112
	W01-358-7848	130
200041	W01-358-9394	62
200042	W01-358-6902	105
200182	W01-358-9251	69
201150	W01-358-9249	69
201642	W01-358-8752	76
200177	W01-358-7850	131
(Wabash)	W01-358-9928	92
200117	W01-358-8027	125
200175	W01-358-7088	99
200792	W01-358-7096	100
TAFCO		
	W01-358-8010	124
1003588753C	W01-358-8753	76
1003589053C	W01-358-9053	36
1003588802C	W01-358-8802	39
1003588803C	W01-358-8803	39
1003588805C	W01-358-8805	40
1003588806C	W01-358-8806	40
1003588919C	W01-358-8919	24
1003588924C	W01-358-8924	45
1003588930C	W01-358-8930	35
1003588963C	W01-358-8963	29

Manufacturer Name/ Part Number	Firestone AON	Page No.
TALBERT		
	W01-358-7180	111
TARTAN		
	W01-358-7726	100
TEMISKO		
	W01-358-9122	88
	W01-358-7140	118
	W01-358-7816	128
TEXAS TRUCK		
	W01-358-7325	103
TRANSPORTATION		
	W01-358-7726	100
TRUCKSTELL (Marion Mfg.)		
63640	W01-358-7808	128
63641	W01-358-7135	117
63644	W01-358-7135	117
63647	W01-358-9101	60
TUTHILL GRANNING		
700135-01	W01-358-9825	92
700136-01	W01-358-9825	92
700999-01	W01-358-8733	78
702228-01	W01-358-8761	81
702932-01	W01-358-6856	104
703180-01	W01-358-9556	38
703667-01	W01-358-8787	81
705951-01	W01-358-8636	78
TUTHILL REYCO		
23027-01	W01-358-8935	36
23631-01	W01-358-8051	94
701784-01	W01-358-6886	108
702614-01	W01-358-8824	45
ULTRARIDE		
	W01-358-5439	12
1003589423C	W01-358-9423	67
1003589445C	W01-358-9445	21

Cross References

1T & Convuluted Manufacturer to Firestone Number

Manufacturer Name/ Part Number	Firestone AON	Page No.
UNIT RIG		
1001404	W01-358-7244	121
1016031	W01-358-7294	122
1016034	W01-358-9135	85
V-STEER 1		
(Ride Bag)	W01-358-9948	56
(Lift Bag)	W01-358-6890	103
V-STEER II		
(Lift Bag)	W01-358-6943	109
(Ride Bag)	W01-358-8042	127
VAN RADEN		
	W01-358-6943	109
VOLVO		
3934699	W01-358-8829	45
8079902		
8061151	W01-358-9296	49
8169868	W01-358-9296	49
VOLVO/GM HEAVY DUTY TRUCK		
2076095	W01-358-7401	112
35003-3209	W01-358-9219	48
35203-0005	W01-358-7145	118
35003-3201	W01-358-9219	48
35203-3203	W01-358-9219	48
35003-3204	W01-358-9219	48
WABASH		
	W01-358-7276	133
	W01-358-9366	38
WABASH (Roadrailer)		
	W01-358-8984	94
WABASH TRAILER		
	W01-358-8203	34
WAGGONER'S TRUCK		
	W01-358-9439	25
	W01-358-9438	25
WATSON & CHALIN		
	W01-358-9350	62
	W01-358-8018	125
AS-0001	W01-358-6910	104

Manufacturer Name/ Part Number	Firestone AON	Page No.
WATSON & CHALIN cont.		
AS-0002	W01-358-6902	105
AS-0004	W01-358-7136	117
AS-0005	W01-358-7446	115
AS-0006	W01-358-7798	127
AS-0007	W01-358-7403	112
AS-0008	W01-358-7140	118
AS-0011	W01-358-9082	46
AS-0012	W01-358-9039	31
AS-0013	W01-358-9121	84
AS-0014	W01-358-7401	112
AS-0015	W01-358-9105	37
AS-0019	W01-358-8008	124
AS-0019-1F (ref. W01-358-8008)	W01-358-7994	123
AS-0020	W01-358-6905	105
AS-0021	W01-358-6801	119
AS-0023	W01-358-9122	88
AS-0025	W01-358-7818	128
AS-0026	W01-358-8997	9
AS-0027 (replaces 7416)	W01-358-7443	114
AS-0028	W01-358-9083	46
AS-0029	W01-358-5410	10
AS-0030	W01-358-7325	103
AS-0032 (replaces 7240)	W01-358-7782	120
AS-0033	W01-358-7839	129
AS-0034	W01-358-6808	120
AS-0034 (see W01-358-6808)	W01-358-6800	119
AS-0035	W01-358-6908	106
AS-0036	W01-358-9321	63
AS-0038 AS-0046	W01-358-9192	60
AS-0039	W01-358-8051	94
AS-0039	W01-358-8053	94
AS-0040	W01-358-9101	60
AS-0041	W01-358-6943	109
AS-0042	W01-358-5770	67

Firestone

1T & Convuluted Manufacturer to Firestone Number

Manufacturer Name/ Part Number	Firestone AON	Page No.
WATSON & CHALIN cont.		
AS-0043	W01-358-9004	46
AS-0044	W01-358-9010	41
AS-0045	W01-358-7273	122
AS-0047	W01-358-5503	90
AS-0048	W01-358-8032	125
AS-0048	W01-358-7990	123
AS-0048-1F (ref. W01-358-8032)	W01-358-7995	123
AS-0049	W01-358-9362	50
AS-0053	W01-358-9336	43
AS-0054	W01-358-9366	38
AS-0056	W01-358-9346	61
AS-0057	W01-358-9370	64
AS-0058	W01-358-6897	105
AS-0058-1F	W01-358-6886	108
AS-0059	W01-358-9304	49
AS-0060	W01-358-9984	93
AS-0061	W01-358-9243	61
AS-0062	W01-358-8927	46
AS-0063	W01-358-9915	92
AS-0063	W01-358-9264	92
AS-0064	W01-358-7792	121
AS-0069	W01-358-5433	11
AS-0073	W01-358-9218	83
AS-0078	W01-358-8053	94
AS-0081	W01-358-9985	90
AS-0084	W01-358-8752	76
AS-0086 (Replaces old 7837 supersedes 7851 - adaper plates might be required)	W01-358-7850	131
AS-0087	W01-358-7550	116
AS-0087-1F	W01-358-7545	116
AS-0088	W01-358-7788	107
AS-0089	W01-358-7557	120
AS-0090	W01-358-9921	54
AS-0092	W01-358-6883	108

Manufacturer Name/ Part Number	Firestone AON	Page No.
WATSON & CHALIN cont.		
AS-0098	W01-358-8753	76
AS-0106	W01-358-5297	8
AS-006 (Replaces 7503)	W01-358-7705	103
Western Star (cab spring)		
	W01-358-7025	101
Willmar		
	W01-358-9036	30
	W01-358-7512	121
	W01-358-7146	118
Wilson Trailer		
	W01-358-8614	79

Cross References

OE Suspeions Index

Manufacturer Name/ Part Number	Firestone AON	Page No.
HENDRICKSON AUXILLARY HLM Series		
HL-015		
(Ride)	W01-358-8050	93
(Lift)	W01-358-7403	112
HLM-1&2		
(Ride)	W01-358-9367	64
(Lift)	W01-358-6935	106
MTL-45&50		
(Ride)	W01-358-9367	64
(Lift)	W01-358-6902	105
HENDRICKSON AUXILLARY HLN Series		
HLN(Truck)		
(Ride)	W01-358-8033	126
(Lift)	W01-358-7795	107
HLN (Trailer)		
(Ride)	W01-358-8042	127
(Lift)	W01-358-7795	107
HENDRICKSON AUXILLARY HLP Series		
HLP		
(Ride)	W01-358-8033	126
(Lift)	W01-358-7795	107
HLP (Trailer)		
(Ride)	W01-358-8042	127
(Lift)	W01-358-7795	107
HENDRICKSON AUXILLARY HLQ Series		
QS16A-X	W01-358-7403	112
QT20A-X	W01-358-7790	116
QU22C-X&QU22D-X	W01-358-9105	37
QW12A-X	W01-358-7136	117
HENDRICKSON AUXILLARY HLR Series		
ST-004		
(Ride)	W01-358-7843	129
(Lift)	W01-358-6902	105
ST-031		
(Ride)	W01-358-7846	130
(Lift)	W01-358-6902	105

Manufacturer Name/ Part Number	Firestone AON	Page No.
HENDRICKSON AUX HLR Series cont.		
RT14D-X (Truck)		
(Ride)	W01-358-7847	130
(Lift)	W01-358-7403	112
RW14A-X		
(Ride)	W01-358-7843	129
(Lift)	W01-358-6902	105
RW14B-X&14C-X (trailer)		
(Ride)	W01-358-7847	130
(Lift)	W01-358-7403	112
HENDRICKSON AUXILLARY HLU Series		
HLU		
(Ride)	W01-358-8033	126
(Lift)	W01-358-7795	107
HLUS		
(Ride)	W01-358-8033	126
(Lift)	W01-358-7795	107
HLUH (ultra high lift)		
(Ride)	W01-358-7862	131
(Lift)	W01-358-7545	116
HLUR (pararev)		
(Ride)	W01-358-8033	126
(Lift)	W01-358-7897	108
HENDRICKSON TRAILER T-Series		
T-15-140, 150, 172, 244, 376	W01-358-8050	93
T-15-324	W01-358-8050	93
T-17-141, 174, 284	W01-358-8050	93
T-30-US-9,17	W01-358-9122	88
T-4-392	W01-358-9010	41
T-6-062	W01-358-9039	31
T-6-071	W01-358-9105	37
T-6-295	W01-358-9039	31
T-6-370	W01-358-9039	31
T-6-422	W01-358-9039	31

Firestone

OE Suspension Index

Manufacturer Name/ Part Number	Firestone AON	Page No.
HENDRICKSON TRAILER T-Series		
T-9-084	W01-358-9122	88
T-9-106,278,313	W01-358-9082	46
T-9-175	W01-358-9158	89
T-9-325	W01-358-9092	47
T-9-390	W01-358-9092	47
TDC-014	W01-358-9039	31
TMB-14-120	W01-358-9082	46
TMB-17-135	W01-358-9082	46
HENDRICKSON TRAILER HT-SERIES		
HT190T	W01-358-9640	39
HT190U	W01-358-8944	52
HT230T	W01-358-9270	70
HT250T	W01-358-9265	63
HT250U	W01-358-9265	63
HT250U"Y"	W01-358-9265	63
HT-250U	W01-358-9299	52
HT-250U-Y (majority of versions)	W01-358-9265	63
HT-250U-Y	W01-358-9580	80
HT-250U-Y	W01-358-9580	80
HT-250US	W01-358-9580	80
HT-250US	W01-358-9580	80
HT-250US	W01-358-9265	63
HT-250US	W01-358-9265	63
HT-250US	W01-358-9299	52
HT-300T (all)	W01-358-8050	93
HT-300U (all)	W01-358-9122	88
HENDRICKSON TRAILER Intraax Series		
AA230T	W01-358-8709	79
AA250T (reuse metal disk)	W01-358-8091	83
AA230L	W01-358-9626	27
AA230L	W01-358-9621	28
AA230L	W01-358-9619	28
AA250L	W01-358-9644	51
AA250L	W01-358-9646	63
AA250L	W01-358-9645	65

Manufacturer Name/ Part Number	Firestone AON	Page No.
HENDRICKSON TRAILER HT Dolly		
HT Dolly	W01-358-9640	39
HT Dolly	W01-358-9270	70
HENDRICKSON TRAILER Slider Box		
HS-190T	W01-358-9640	39
HS-230	W01-358-9270	70
HK-190T	W01-358-8755	76
HK-230	W01-358-8756	76
HENDRICKSON TRAILER Van Traax		
HKA-180	W01-358-8713	80
HKA-180	W01-358-8709	79
HKA-200	W01-358-8708	80
HKA-250 (reuse metal disk)	W01-358-8091	83
HENDRICKSON TRAILER Lifts		
CL	W01-358-7136	117
CL	W01-358-6801	119
HTCL	W01-358-7447	115
HENDRICKSON TRUCK		
HA360		
(up to 1991)	W01-358-9466	52
(1991 and up)	W01-358-9287	56
HA400		
(up to 1991)	W01-358-9466	52
(1991 and up)	W01-358-9287	56
HA460		
(up to 1991)	W01-358-9466	52
(1991 and up)	W01-358-9287	56
HAS40LH	W01-358-9297	57
HAS360	W01-358-9373	57
HAS400	W01-358-9373	57
HAS402	W01-358-9373	57
HAS460	W01-358-9373	57
HAS210/230/400/460	W01-358-9656	59
AIRTEK 12K/12.6K/14.6K	W01-358-8597	19
PAX460	W01-358-9663	59

Cross References

OE Suspeions Index

Manufacturer Name/ Part Number	Firestone AON	Page No.
HOLLAND LIFT SUSPENSIONS		
AL-40-US (Lift)	W01-358-7424	114
AL-41, AL-41-US (Lift)	W01-358-7424	114
AL-42, AL-42-US (Lift)	W01-358-7424	114
AL-45-9, 12, 14, 17 (Lift)	W01-358-7424	114
AL-50, AL-50US (Lift)	W01-358-7424	114
AL-70, AL-70-US (Lift)	W01-358-7424	114
AL-75-B, AL-76-A, AL-77, AL-78 (Lift)	W01-358-7135	117
ALT-40, ALT-40-L (Lift)	W01-358-7424	114
ALT-40-US, ALT-50-US, ALT-70-US (Lift)	W01-358-7424	114
ALT-500-US, ALT-550-US (Lift)		
HOLLAND TRAILER AIR		
AR-41, AR-45, AR-45-1	W01-358-9039	31
AR-50-US, -F, -F-1,-F-2, AR-51-US	W01-358-9039	31
AR-70-9, AR-70-14	W01-358-9121	84
AR-70A-9, -14	W01-358-9121	84
AR-75-12, 1-12	W01-358-9101	60
AR-75-12, 1-12		
AR-75-6, -9	W01-358-9082	46
AR-80-6.75	W01-358-9121	84
AR-80-9	W01-358-9134	88
AR-80-9FM	W01-358-9138	88
AR-80-9-WST	W01-358-9134	88
AR-85-A	W01-358-9121	84
AR-90-1-12	W01-358-9463	43
AR-90-1-12	W01-358-9463	43
AR-90-1-14, 17	W01-358-9362	50

Manufacturer Name/ Part Number	Firestone AON	Page No.
HOLLAND TRAILER AIR cont.		
AR-90-1-15, 16	W01-358-9304	49
AR-90-14,15,16,17	W01-358-9243	61
AR-92-12, 14	W01-358-9921	54
AR-92-15	W01-358-9921	54
AR-92-16	W01-358-9921	54
AR-92-17	W01-358-9921	54
AR-92-18	W01-358-9921	54
AR-93-14	W01-358-9921	54
AR-93-15	W01-358-9923	54
AR-93-16	W01-358-9923	54
AR-93-17	W01-358-9922	54
AR-120	W01-358-9082	46
AR-120-L	W01-358-9101	60
AR-120-US	W01-358-9082	46
AR-120-US-F	W01-358-9082	46
AR-120-US-L-1,2,3	W01-358-9101	60
AR-125	W01-358-9177	86
AR-125-L	W01-358-9158	89
AR-125-US	W01-358-9177	86
AR-125-US-F	W01-358-9121	84
AR-125-US-L-1,2,3	W01-358-9158	89
AR-165-US	W01-358-9082	46
AR-955-9, 12, 14, 17	W01-358-9122	88
AR-955-9-HD, 12-HD, 14-HD, 17-HD	W01-358-9122	88
AR-955A-9, 12, 14, 17	W01-358-9122	88
AR-955A-9-HD, 12-HD, 14-HD, 17-HD	W01-358-9122	88
AR-95-9,12,14,17	W01-358-9122	88
AR-95-9-HD, 12-HD, 14-HD, 17-HD	W01-358-9122	88
AR-95A-9,-12, -14, -17	W01-358-9122	88
AR-95A-9-HD, 12-HD, 14-HD, 17-HD	W01-358-9122	88
ARDST-246	W01-358-9121	84
ARL-20-D	W01-358-7437	114

Firestone

OE Suspension Index

Manufacturer Name/ Part Number	Firestone AON	Page No.
HOLLAND TRAILER AIR cont.		
ARL-20-D	W01-358-9039	31
ARL-20-D-US	W01-358-7437	114
ARL-20-D-US	W01-358-9039	31
ARU-92-10	W01-358-9243	61
ARU-92-8	W01-358-9921	54
ARU-92-9	W01-358-9243	61
ARU-93-6	W01-358-9921	54
ARU-93-7	W01-358-9921	54
CB-2300	W01-358-9974	56
NS190	W01-358-9366	38
NS190-16	W01-358-8204	34
RL-196-12	W01-358-9294	27
RL-196-14	W01-358-9293	27
RL-196-15	W01-358-9295	27
RL-196-16	W01-358-9295	27
RL-196-17	W01-358-9291	26
RL-196A-14	W01-358-9293	27
RL-196A-15	W01-358-9295	27
RL-196A-16	W01-358-9295	27
RL-300	W01-358-8764	90
RL228-14, 15, 16	W01-358-9936	55
RL228-17	W01-358-8749	77
RL250-12,	W01-358-8749	77
RL250-14,15	W01-358-8748	77
RL250-16, 17	W01-358-8749	77
RLU-228 (12) -4	W01-358-9346	61
RLU-228 (6,7) -3	W01-358-9921	54
RLU-228 (8) -3	W01-358-9923	54
RLU-228 (8) -4	W01-358-9921	54
RLU-228 (9,10) -3	W01-358-9922	54
RLU-228 (9,10) -4	W01-358-9243	61
RLU-250 (12)	W01-358-8744	77
RLU-250 (6.75,9)	W01-358-8746	77
Intermodel	W01-358-9896	92

Manufacturer Name/ Part Number	Firestone AON	Page No.
HOLLAND POWERED TRUCK		
AD-123,246(6.5,8.75)	W01-358-9472	71
AD-123,246(10)	W01-358-9471	71
AD-123,246(FORD)	W01-358-9472	71
AD-123	W01-358-9502	72
AD-123	W01-358-9501	72
AD-200(7)	W01-358-9482	43
AD-200(8)	W01-358-9483	44
AD-200(9)	W01-358-9496	50
AD-200(11)	W01-358-9471	71
ADTB	W01-358-9697	44
ARDST-123/244-6	W01-358-9082	46
ARDST-244-6	W01-358-9193	47
ARDST-246-6, ARDSTM/L-246-6	W01-358-9121	84
ARDTB-125-6A	W01-358-8053	94
ARDAB-120-5, 240-5	W01-358-9268	38
ARD-120-6, ARD-238-6	W01-358-9082	46
ARD-125-6, 244-6	W01-358-9093	47
ARD-125-6, 244-6	W01-358-9082	46
ARD-125, -6, 244-6	W01-358-9082	46
ARD-125, -8, 244-8	W01-358-9082	46
ARD-125, -8, 244-8	W01-358-9082	46
ARD-165-A	W01-358-9082	46
ARD-165-B	W01-358-9082	46
ARD-190-B	W01-358-9082	46
ARL-20-D, -US	W01-358-7437	114
ARL-20-D, -US	W01-358-9039	31
HOLLAND NON-POWERED TRUCK		
IFS-114	W01-358-8198	34
ART-500-B, -B1	W01-358-9082	46
ART-550-US	W01-358-9082	46

Cross References

OE Suspeions Index

Manufacturer Name/ Part Number	Firestone AON	Page No.
HOLLAND NON-POWERED TRUCK cont.		
ART-500-US-A	W01-358-9082	46
ART-505-B, B-1	W01-358-9082	46
ART-500-B, -B1	W01-358-9082	46
ART-505-C, C-1	W01-358-9082	46
ART-505-B, B-1	W01-358-9082	46
ART-541-B	W01-358-9082	46
ART-505-B, B-1	W01-358-9082	46
ART-505-C, C-1	W01-358-9082	46
TC-120-D	W01-358-9082	46
ART-551-B-1, -2, -3	W01-358-9101	60
ART-551-US-1, -2, -3	W01-358-9101	60
ART-555-B-1, -2, -3	W01-358-9101	60
ART-551-B-1, -2, -3	W01-358-9101	60
ART-555-C-1, -2, -3	W01-358-9101	60
ART-551-B-1, -2, -3	W01-358-9101	60
ART-555-B-1, -2, -3	W01-358-9101	60
ART-551-B-1, -2, -3	W01-358-9101	60
TC-120-D, -44	W01-358-9177	86
WATSON CHALIN STEERING LIFTABLES		
LWSTL-1100		
(Ride)	W01-358-8008	124
(Lift)	W01-358-6897	105
STL-1100 TRU-TRACK		
(Ride)	W01-358-8032	125
(Lift)	W01-358-6897	105
STL-1800		
(Ride)	W01-358-7798	127
(Lift)	W01-358-6897	105

Manufacturer Name/ Part Number	Firestone AON	Page No.
WATSON CHALIN TRAILER		
TA-250-14,15,16,17	W01-358-8753	76
TA-250U-12	W01-358-9243	61
TA-250U-14	W01-358-9243	61
TA-250U-5.5	W01-358-9243	61
TA-250U-7.5	W01-358-9243	61
TA-250U-7.5FS	W01-358-9243	61
TA-250U-9	W01-358-9243	61
TA-251-10	W01-358-9243	61
TA-251-12	W01-358-9243	61
TA-251-6.5FS	W01-358-9243	61
TA-251-7.5	W01-358-9243	61
TA-251-8FS	W01-358-9243	61
TA-251-9.0	W01-358-9243	61
TA-251-9.0 FS	W01-358-9243	61
TA-2590-12,14,15	W01-358-9243	61
TA-280-7.5	W01-358-9243	61
TA-280-9.0	W01-358-9243	61
TA-280D	W01-358-9039	31
TA-300-15	W01-358-8050	93
TA-300-16/17	W01-358-8050	93
TA-300-17	W01-358-8050	93
TA-300-22	W01-358-8050	93
TA-300-23B	W01-358-8050	93
TA-300-9	W01-358-9121	84
TA-300FM-16B	W01-358-8050	93
AR-95-9,12,14,17	W01-358-9122	88
AR-95-9-HD, 12-HD, 14-HD, 17-HD	W01-358-9122	88
AR-95A-9,-12, -14, -17	W01-358-9122	88
AR-95A-9-HD, 12-HD, 14-HD, 17-HD	W01-358-9122	88
ARDST-246	W01-358-9121	84
ARL-20-D	W01-358-7437	114
TA-300U-12	W01-358-9122	88
TA-300U-14	W01-358-9122	88
TA-300U-17	W01-358-9122	88

Firestone

OE Suspension Index

Manufacturer Name/ Part Number	Firestone AON	Page No.
WATSON CHALIN TRAILER cont		
TA-300U-9	W01-358-9122	88
TA-3090-14	W01-358-9121	84
TA-3090-17	W01-358-9122	88
TA-3090-19	W01-358-9122	88
TA-5000-DB-24	W01-358-8050	93
TA-5000-DB-30	W01-358-8050	93
TA-5000-F-24	W01-358-8050	93
TA-525DB	W01-358-8050	93
TA-525FS	W01-358-8050	93
TA-791	W01-358-9921	54
TA-791-17-B	W01-358-9243	61
TA-2075 (12)	W01-358-9101	60
TA-2075-9	W01-358-9082	46
WATSON CHALIN LIFTABLES		
TL-1100	W01-358-6897	105
(Lift)		
TL-2200-23 thru 34		
(Ride)	W01-358-9370	64
(Lift)	W01-358-6897	105
TL-2200-9 thru 20		
(Ride)	W01-358-9370	64
(Lift)	W01-358-6897	105
TL-2200LP		
(Lift)	W01-358-6897	105
(Ride)	W01-358-9243	61
TL-2200-SSR		
(Ride)	W01-358-9370	64
(Lift)	W01-358-6897	105
TL-2590-12,14,15	W01-358-9243	61
TL-2590-14,17 HD	W01-358-9243	61
TL-2700-HD-14-ES	W01-358-6943	109
TL-800 (Ride)	W01-358-8032	125
TL-8100		
(Ride)	W01-358-8032	125
(Lift)	W01-358-6897	105

Manufacturer Name/ Part Number	Firestone AON	Page No.
WATSON CHALIN LIFTABLES cont.		
TL-9000-16B		
(Ride)	W01-358-8008	124
(Lift)	W01-358-6897	105
TL-9000-17.5/16.5		
(Ride)	W01-358-8008	124
(Lift)	W01-358-6897	105
TL-9000-19		
(Ride)	W01-358-8008	124
(Lift)	W01-358-6897	105
TL-9000-21		
(Ride)	W01-358-8008	124
(Lift)	W01-358-6897	105
TL-9000-24 (Ride)	W01-358-8008	124
TL-9000-30		
(Ride)	W01-358-8008	124
(Lift)	W01-358-6897	105
TLC-2590-12,14,15	W01-358-9243	61
TRU-TRACK		
(Ride)	W01-358-8008	124
(Lift)	W01-358-6897	105
WB-2500-6	W01-358-9105	37
WB-2500-7.5	W01-358-9082	46
WB-2500-9	W01-358-9082	46
WB-251-7.5	W01-358-9243	61
WB-251-9.0	W01-358-9243	61
WB-280-9.0	W01-358-9243	61
WATSON CHALIN TRUCK		
SL-2200-13.5, -15		
(Lift)	W01-358-9370	64
(Ride)	W01-358-6897	105
AL-2200-LP		
(Lift)	W01-358-9370	64
(Ride)	W01-358-6897	105
AL-2200 ES		
(Ride)	W01-358-6897	105
AS-0048		
(Ride)	W01-358-7990	123

Cross References

1T & Convuluted Goodyear Assembly Number to Firestone

GOODYEAR PART NO.	GOODYEAR BELLOWS NO.	FIRESTONE AON	PAGE No.
1B12-300	N/A	W01-358-7008	98
1B12-301	578913301	W01-358-7009	98
1B12-305	578913301	W01-358-7043	98
1B12-313	N/A	W01-358-7008	98
1B12-900	N/A	W01-358-7043	98
1B14-350	578913351	W01-358-7103	99
1B14-351	578913351	W01-358-7104	99
1B14-358	578913352	W01-358-7112	100
1B14-362	N/A	W01-358-7096	100
1R10-013	N/A	W01-358-9238	61
1R10-036	N/A	W01-358-9049	14
1R10-101	566203027	W01-358-5770	67
1R10-101	566203027	W01-358-5770	67
1R10-120	566203021	W01-358-9293	27
1R10-122	566203021	W01-358-9291	26
1R11-018	566223006	W01-358-9073	14
1R11-018	566223006	W01-358-9415	25
1R11-028	566223021	W01-358-9422	18
1R11-039	566223143	W01-358-9439	25
1R11-039	566223143	W01-358-9439	25
1R11-051	N/A	W01-358-9073	14
1R11-066	566223021	W01-358-9447	21
1R11-150	566223021	W01-358-9448	21
1R11-151	566223021	W01-358-9457	21
1R11-152	566223021	W01-358-9459	22
1R11-152	566223021	W01-358-9459	22
1R11-161	566223057	W01-358-5766	66
1R11-166	566223048	W01-358-9295	27
1R11-171	566223057	W01-358-9421	67
1R11-191	566223143	W01-358-8919	24
1R11-200	566223021	W01-358-9376	20
1R11-201	566223021	W01-358-9377	20
1R11-202	566223021	W01-358-9378	20
1R11-203	566223021	W01-358-9387	20
1R11-204	566223021	W01-358-8900	19
1R11-205	566223021	W01-358-9476	22
1R11-219	566223021	W01-358-9617	17
1R11-220	566223021	W01-358-9618	18
1R11-221	566223021	W01-358-9622	17
1R11-222	566223021	W01-358-9625	18

GOODYEAR PART NO.	GOODYEAR BELLOWS NO.	FIRESTONE AON	PAGE No.
1R11-225	566223057	W01-358-9650	66
1R12-014	566243019	W01-358-9098	52
1R12-047	566243019	W01-358-9098	52
1R12-066	566243038	W01-358-9083	46
1R12-069	566243038	W01-358-9069	42
1R12-090	566243038	W01-358-9213	48
1R12-092	566243038	W01-358-9082	46
1R12-093	566243038	W01-358-9082	46
1R12-095	566243067	W01-358-9039	31
1R12-095	566243067	W01-358-9307	33
1R12-097	566243067	W01-358-9039	31
1R12-103	566243066	W01-358-9101	60
1R12-113	566243066	W01-358-9101	60
1R12-130	566243038	W01-358-9227	49
1R12-132	566243076	W01-358-9105	37
1R12-132	566243076	W01-358-9113	37
1R12-132	566243076	W01-358-9302	37
1R12-142	566243066	W01-358-9394	62
1R12-143	566243048	W01-358-9392	50
1R12-143	566243038	W01-358-9392	50
1R12-145	566243066	W01-358-9238	61
1R12-155	566243038	W01-358-9096	47
1R12-167	566243066	W01-358-9192	60
1R12-173	566243173	W01-358-9466	52
1R12-178	566243067	W01-358-9379	24
1R12-182	566243038	W01-358-9219	48
1R12-182	566243110	W01-358-9219	48
1R12-186	566243275	W01-358-9780	73
1R12-188	566243038	W01-358-9223	48
1R12-189	566243275	W01-358-9780	73
1R12-195	566243066	W01-358-9349	62
1R12-197	566243173	W01-358-9466	52
1R12-204	566243067	W01-358-9566	23
1R12-205	566243076	W01-358-9568	26
1R12-220	566243038	W01-358-9092	47
1R12-256	566243090	W01-358-9321	63
1R12-256	566243090	W01-358-9367	64
1R12-256	566243090	W01-358-9367	64
1R12-261	566243066	W01-358-9394	62
1R12-265	566243066	W01-358-9245	61

Firestone

1T & Convuluted Goodyear Assembly Number to Firestone

GOODYEAR PART NO.	GOODYEAR BELLOWS NO.	FIRESTONE AON	PAGE No.
1R12-275	NA	W01-358-9240	61
1R12-278	566243066	W01-358-9394	62
1R12-279	566243066	W01-358-9394	62
1R12-281	566243066	W01-358-9394	62
1R12-281	566243066	W01-358-9394	62
1R12-303	566243275	W01-358-9780	73
1R12-309	566243067	W01-358-9053	36
1R12-309	566243067	W01-358-9053	36
1R12-324	566243067	W01-358-9565	23
1R12-324	566243067	W01-358-9565	23
1R12-324	566243067	W01-358-9566	23
1R12-325	566243076	W01-358-9567	26
1R12-335	566243090	W01-358-9321	63
1R12-350	566243067	W01-358-9031	30
1R12-351	566243067	W01-358-9033	30
1R12-352	566243076	W01-358-9010	41
1R12-355	566243076	W01-358-9078	36
1R12-356	566243038	W01-358-9194	47
1R12-357	566243066	W01-358-9348	62
1R12-358	566243038	W01-358-9096	47
1R12-359	566243067	W01-358-9077	31
1R12-359	566243061	W01-358-9077	31
1R12-363	566243090	W01-358-9320	63
1R12-365	566243038	W01-358-9466	52
1R12-365	566243180	W01-358-9466	52
1R12-365	566243173	W01-358-9466	52
1R12-366	566243038	W01-358-8944	52
1R12-367	566243076	W01-358-9640	39
1R12-370	566243076	W01-358-9070	42
1R12-370	566243076	W01-358-9336	43
1R12-370	566243076	W01-358-9336	43
1R12-373	566243080	W01-358-9491	72
1R12-375	566243066	W01-358-9265	63
1R12-395	566243066	W01-358-9203	60
1R12-398	566243038	W01-358-9648	58
1R12-398	566243000	W01-358-9648	58
1R12-401	566243038	W01-358-9371	57
1R12-402	566243097	W01-358-9297	57
1R12-403	566243097	W01-358-9373	57
1R12-404	566243097	W01-358-9375	57

GOODYEAR PART NO.	GOODYEAR BELLOWS NO.	FIRESTONE AON	PAGE No.
1R12-405	566243097	W01-358-8829	45
1R12-405	566243110	W01-358-8829	45
1R12-421	566211076	W01-358-9010	41
1R12-424	566243097	W01-358-9287	56
1R12-424	566243225	W01-358-9287	56
1R12-434	566243076	W01-358-8802	39
1R12-435	566243067	W01-358-9307	33
1R12-435	566243067	W01-358-9334	32
1R12-436	566243038	W01-358-8924	45
1R12-437	566243076	W01-358-9797	45
1R12-438	566243038	W01-358-8805	40
1R12-439	566243066	W01-358-9346	61
1R12-440	566243090	W01-358-9370	64
1R12-441	566243038	W01-358-9362	50
1R12-445	566243076	W01-358-8802	39
1R12-445	566243076	W01-358-8806	40
1R12-445	566243076	W01-358-8806	40
1R12-446	566243097	W01-358-9245	61
1R12-480	566243066	W01-358-9243	61
1R12-481	566243097	W01-358-9923	54
1R12-487	566243067	W01-358-9366	38
1R12-498	566243097	W01-358-9922	54
1R12-499	566243038	W01-358-9936	55
1R12-501	N/A	W01-358-9293	27
1R12-502	566243097	W01-358-9921	54
1R12-503	566243090	W01-358-9370	64
1R12-504	566243066	W01-358-9471	71
1R12-505	566243076	W01-358-9325	37
1R12-522	566243067	W01-358-8204	34
1R12-532	566243097	W01-358-9935	55
1R12-533	566243097	W01-358-9923	54
1R12-538	566243038	W01-358-9648	58
1R12-552	566243038	W01-358-9471	71
1R12-553	566243038	W01-358-9472	71
1R12-554	566243038	W01-358-9470	71
1R12-555	566243067	W01-358-8961	28
1R12-557	566243067	W01-358-8976	29
1R12-558	566243067	W01-358-8986	30
1R12-559	566243067	W01-358-9029	30
1R12-560	566243067	W01-358-9308	31

Cross References

1T & Convoluted Goodyear Assembly Number to Firestone

GOODYEAR PART NO.	GOODYEAR BELLOWS NO.	FIRESTONE AON	PAGE No.
1R12-561	566243067	W01-358-9332	31
1R12-562	566243067	W01-358-8197	33
1R12-563	566243067	W01-358-8934	36
1R12-566	566243067	W01-358-8964	29
1R12-567	566243038	W01-358-9026	46
1R12-568	566243066	W01-358-8852	59
1R12-571	566243067	W01-358-9365	38
1R12-586	566243038	W01-358-9473	71
1R12-603	566243275	W01-358-9780	73
1R12-620	566243076	W01-358-9335	43
1R12-620	566243076	W01-358-9335	43
1R12-663	566243090	W01-358-9320	63
1R12-669	566243038	W01-358-9069	42
1R12-901	566243055	W01-358-9053	36
1R12-903	566243038	W01-358-9223	48
1R12-907	N/A	W01-358-9026	46
1R12-911	N/A	W01-358-9922	54
1R13-038	566263015	W01-358-9122	88
1R13-039	566263051	W01-358-9121	84
1R13-043	566263051	W01-358-9121	84
1R13-047	566263051	W01-358-9144	85
1R13-048	566263072	W01-358-9122	88
1R13-049	566263051	W01-358-9121	84
1R13-077	566263036	W01-358-9270	70
1R13-097	566263050	W01-358-8723	75
1R13-102	N/A	W01-358-9270	70
1R13-109	566263050	W01-358-8782	77
1R13-115	566263044	W01-358-9250	73
1R13-116	566263044	W01-358-9252	73
1R13-117	566263043	W01-358-9275	71
1R13-118	566263034	W01-358-9580	80
1R13-119	566263036	W01-358-9270	70
1R13-119	566263053	W01-358-9270	70
1R13-120	566263054	W01-358-9218	83
1R13-124	566263050	W01-358-8710	79
1R13-124	566263050	W01-358-8755	76
1R13-128	N/A	W01-358-8708	80
1R13-130	566263055	W01-358-8729	75
1R13-144	566263144	W01-358-9580	80
1R13-152	566263071	W01-358-8748	77

GOODYEAR PART NO.	GOODYEAR BELLOWS NO.	FIRESTONE AON	PAGE No.
1R13-153	566263071	W01-358-8749	77
1R13-159	566263073	W01-358-8709	79
1R13-176	566263078	W01-358-8713	80
1R13-177	566263080	W01-358-8708	80
1R13-908	N/A	W01-358-9134	88
1R14-018	566283021	W01-358-9149	85
1R14-019	566283020	W01-358-9152	89
1R14-019	566283020	W01-358-9152	89
1R14-019	566283020	W01-358-9156	89
1R14-024	566283021	W01-358-9149	85
1R14-025	566283020	W01-358-9156	89
1R14-026	566283021	W01-358-9148	85
1R14-027	566283021	W01-358-9148	85
1R14-028	566283021	W01-358-9177	86
1R14-028	566283021	W01-358-9179	86
1R14-029	566283021	W01-358-9177	86
1R14-030	566283020	W01-358-9158	89
1R14-031	566283020	W01-358-9158	89
1R14-037	566283015	W01-358-9215	82
1R14-038	566283015	W01-358-9200	82
1R14-039	566283015	W01-358-8050	93
1R14-042	566283015	W01-358-8052	94
1R14-045	566283020	W01-358-8792	88
1R14-045	566283020	W01-358-9122	88
1R14-054	N/A	W01-358-9158	89
1R14-055	566283023	W01-358-8050	93
1R14-083	566283023	W01-358-8050	93
1R14-113	566283030	W01-358-5505	90
1R14-115	566283021	W01-358-9961	86
1R14-127	566283029	W01-358-9264	92
1R14-137	566283021	W01-358-9134	88
1R14-147	566283015	W01-358-8053	94
1R14-159	566283021	W01-358-9164	85
1R14-160	566283021	W01-358-9144	85
1R14-171	566283015	W01-358-8091	83
1R14-172	566283042	W01-358-8774	84
1R14-174	566283020	W01-358-5503	90
1R9-038	566183010	W01-358-5406	9
1R9-065	566183003	W01-358-2119	7
1R9-065	566183003	W01-358-8997	9

Firestone

1T & Convuluted Goodyear Assembly Number to Firestone

GOODYEAR PART NO.	GOODYEAR BELLOWS NO.	FIRESTONE AON	PAGE No.
1R9-070	566183004	W01-358-5410	10
1S12-002	566241008	W01-358-8829	45
1S12-022	566241008	W01-358-9296	49
1S12-027	566241012	W01-358-9287	56
1S12-029	566241012	W01-358-9297	57
1S12-030	566241012	W01-358-9373	57
1S12-030	566241012	W01-358-9375	57
1S12-244	566241000	W01-358-9371	57
2B10-226	578923250	W01-358-7795	107
2B12-300	578923309	W01-358-7424	114
2B12-304	N/A	W01-358-7344	111
2B12-304	N/A	W01-358-7344	111
2B12-305	578923310	W01-358-7443	114
2B12-307	578923309	W01-358-7403	112
2B12-309	578923309	W01-358-7400	112
2B12-313	578923309	W01-358-7405	112
2B12-317	578923310	W01-358-7499	116
2B12-318	578923309	W01-358-7185	111
2B12-319	578923309	W01-358-7409	113
2B12-320	578923309	W01-358-7401	112
2B12-320	578923309	W01-358-7437	114
2B12-324	578923310	W01-358-7447	115
2B12-324	N/A	W01-358-7790	116
2B12-324	N/A	W01-358-7790	116
2B12-345	578923315	W01-358-7545	116
2B12-346	578923315	W01-358-7550	116
2B12-402	578923310	W01-358-7446	115
2B12-406	578923309	W01-358-7410	113
2B12-410	578923309	W01-358-7404	112
2B12-411	578923309	W01-358-7181	111
2B12-412	578923309	W01-358-7183	111
2B12-416	578923315	W01-358-7444	115
2B12-425	578923309	W01-358-7180	111
2B12-426	578923309	W01-358-7406	113
2B12-427	578923309	W01-358-7429	114
2B12-428	578923310	W01-358-7473	115
2B12-432	578923309	W01-358-7423	113
2B12-434	578923310	W01-358-7472	116
2B12-440	578923315	W01-358-7550	116
2B12-440	578923315	W01-358-7555	117

GOODYEAR PART NO.	GOODYEAR BELLOWS NO.	FIRESTONE AON	PAGE No.
2B12-446	578923310	W01-358-7444	115
2B14-354	578923353	W01-358-7145	118
2B14-355	578923353	W01-358-7146	118
2B14-356	578923353	W01-358-7136	117
2B14-359	578923353	W01-358-7140	118
2B14-359	578923353	W01-358-7782	120
2B14-360	578923353	W01-358-7135	117
2B14-365	578923356	W01-358-6801	119
2B14-366	578923353	W01-358-6803	119
2B14-367	578923353	W01-358-7123	117
2B14-383	578923356	W01-358-7557	120
2B14-462	578923356	W01-358-6805	119
2B14-470	578923356	W01-358-7782	120
2B14-476	578923356	W01-358-6799	120
2B7-540	N/A	W01-358-3400	102
2B8-550	579923530	W01-358-7325	103
2B9-200	578923202	W01-358-6910	104
2B9-201	578923202	W01-358-6902	105
2B9-201	578923202	W01-358-6935	106
2B9-201	578923202	W01-358-6935	106
2B9-206	578923202	W01-358-6905	105
2B9-210	578923206	W01-358-6908	106
2B9-218	578923206	W01-358-6927	109
2B9-229	578923202	W01-358-6897	105
2B9-229	556238325	W01-358-6897	105
2B9-230	578923202	W01-358-6940	106
2B9-245	578923202	W01-358-7788	107
2B9-246	578923211	W01-358-6932	106
2B9-246	578923206	W01-358-6944	109
2B9-250	578923206	W01-358-6943	109
2B9-251	578923206	W01-358-6948	110
2B9-252	578923206	W01-358-6944	109
2B9-253	578923206	W01-358-6945	109
2B9-254	578923206	W01-358-6946	110
2B9-255	578923206	W01-358-6947	110
2B9-265	578923202	W01-358-6941	106
2B9-352	578923208	W01-358-6944	109
3B12-300	578933100	W01-358-8008	124
3B12-301	578933100	W01-358-8010	124
3B12-303	578933100	W01-358-8018	125

Cross References

1T & Convoluted Goodyear Assembly Number to Firestone

GOODYEAR PART NO.	GOODYEAR BELLOWS NO.	FIRESTONE AON	PAGE No.
3B12-304	578933100	W01-358-8006	124
3B12-310	578933100	W01-358-8027	125
3B12-312	578933100	W01-358-8033	126
3B12-315	578933100	W01-358-8032	125
3B12-319	578933100	W01-358-8032	125
3B12-322	578933103	W01-358-8042	#N/A
3B12-323	578933103	W01-358-8043	127
3B12-328	578933100	W01-358-7994	123
3B12-329	578933100	W01-358-7995	123
3B12-335	578933100	W01-358-7996	123
3B14-350	578933350	W01-358-7808	128
3B14-354	578933350	W01-358-7808	128
3B14-356	578933350	W01-358-7798	127
3B14-356	578933350	W01-358-7838	129
3B14-359	578933350	W01-358-7818	128
3B14-359	578933350	W01-358-7839	129
3B14-360	578933350	W01-358-7800	128
3B14-360	578933350	W01-358-7848	130
3B14-364	578933350	W01-358-7843	129
3B14-367	578933350	W01-358-7847	130
3B14-451	556338335	W01-358-7846	130
3B14-452	556338335	W01-358-7850	131

Firestone

1T & Convuluted Goodyear Bellow Number to Firestone

GOODYEAR BELLOW NO.	GOODYEAR PART NO.	FIRESTONE AON	PAGE No.
556238325	2B9-229	W01-358-6897	105
556338335	3B14-451	W01-358-7846	130
556338335	3B14-452	W01-358-7850	131
566183003	1R9-065	W01-358-2119	7
566183003	1R9-065	W01-358-8997	9
566183004	1R9-070	W01-358-5410	10
566183010	1R9-038	W01-358-5406	9
566203021	1R10-120	W01-358-9293	27
566203021	1R10-122	W01-358-9291	26
566203027	1R10-101	W01-358-5770	67
566203027	1R10-101	W01-358-5770	67
566223006	1R11-018	W01-358-9073	14
566223006	1R11-018	W01-358-9415	25
566223021	1R11-028	W01-358-9422	18
566223021	1R11-066	W01-358-9447	21
566223021	1R11-150	W01-358-9448	21
566223021	1R11-151	W01-358-9457	21
566223021	1R11-152	W01-358-9459	22
566223021	1R11-152	W01-358-9459	22
566223021	1R11-200	W01-358-9376	20
566223021	1R11-201	W01-358-9377	20
566223021	1R11-202	W01-358-9378	20
566223021	1R11-203	W01-358-9387	20
566223021	1R11-204	W01-358-8900	19
566223021	1R11-205	W01-358-9476	22
566223021	1R11-219	W01-358-9617	17
566223021	1R11-220	W01-358-9618	18
566223021	1R11-221	W01-358-9622	17
566223021	1R11-222	W01-358-9625	18
566223048	1R11-166	W01-358-9295	27
566223057	1R11-161	W01-358-5766	66
566223057	1R11-171	W01-358-9421	67
566223057	1R11-225	W01-358-9650	66
566223143	1R11-039	W01-358-9439	25
566223143	1R11-039	W01-358-9439	25
566223143	1R11-191	W01-358-8919	24
566241000	1S12-244	W01-358-9371	57
566241007	1R12-402	W01-358-9297	57
566241008	1S12-002	W01-358-8829	45
566241008	1S12-022	W01-358-9296	49

GOODYEAR BELLOW NO.	GOODYEAR PART NO.	FIRESTONE AON	PAGE No.
566241012	1S12-027	W01-358-9287	56
566241012	1S12-029	W01-358-9297	57
566241012	1S12-030	W01-358-9373	57
566241012	1S12-030	W01-358-9375	57
566243000	1R12-398	W01-358-9648	58
566243019	1R12-014	W01-358-9098	52
566243019	1R12-047	W01-358-9098	52
566243038	1R12-066	W01-358-9083	46
566243038	1R12-069	W01-358-9069	42
566243038	1R12-090	W01-358-9213	48
566243038	1R12-092	W01-358-9082	46
566243038	1R12-093	W01-358-9082	46
566243038	1R12-130	W01-358-9227	49
566243038	1R12-143	W01-358-9392	50
566243038	1R12-155	W01-358-9096	47
566243038	1R12-182	W01-358-9219	48
566243038	1R12-188	W01-358-9223	48
566243038	1R12-220	W01-358-9092	47
566243038	1R12-356	W01-358-9194	47
566243038	1R12-358	W01-358-9096	47
566243038	1R12-365	W01-358-9466	52
566243038	1R12-366	W01-358-8944	52
566243038	1R12-398	W01-358-9648	58
566243038	1R12-401	W01-358-9371	57
566243038	1R12-436	W01-358-8924	45
566243038	1R12-438	W01-358-8805	40
566243038	1R12-441	W01-358-9362	50
566243038	1R12-499	W01-358-9936	55
566243038	1R12-538	W01-358-9648	58
566243038	1R12-552	W01-358-9471	71
566243038	1R12-553	W01-358-9472	71
566243038	1R12-554	W01-358-9470	71
566243038	1R12-567	W01-358-9026	46
566243038	1R12-586	W01-358-9473	71
566243038	1R12-669	W01-358-9069	42
566243038	1R12-903	W01-358-9223	48
566243048	1R12-143	W01-358-9392	50
566243055	1R12-901	W01-358-9053	36
566243061	1R12-359	W01-358-9077	31
566243066	1R12-103	W01-358-9101	60

Cross References

1T & Convuluted Goodyear Bellow Number to Firestone

GOODYEAR BELLOW NO.	GOODYEAR PART NO.	FIRESTONE AON	PAGE No.
566243066	1R12-113	W01-358-9101	60
566243066	1R12-142	W01-358-9394	62
566243066	1R12-145	W01-358-9238	61
566243066	1R12-167	W01-358-9192	60
566243066	1R12-195	W01-358-9349	62
566243066	1R12-261	W01-358-9394	62
566243066	1R12-265	W01-358-9245	61
566243066	1R12-278	W01-358-9394	62
566243066	1R12-279	W01-358-9394	62
566243066	1R12-281	W01-358-9394	62
566243066	1R12-281	W01-358-9394	62
566243066	1R12-357	W01-358-9348	62
566243066	1R12-375	W01-358-9265	63
566243066	1R12-395	W01-358-9203	60
566243066	1R12-439	W01-358-9346	61
566243066	1R12-480	W01-358-9243	61
566243066	1R12-504	W01-358-9471	71
566243066	1R12-568	W01-358-8852	59
566243067	1R12-095	W01-358-9039	31
566243067	1R12-095	W01-358-9307	33
566243067	1R12-097	W01-358-9039	31
566243067	1R12-178	W01-358-9379	24
566243067	1R12-204	W01-358-9566	23
566243067	1R12-309	W01-358-9053	36
566243067	1R12-309	W01-358-9053	36
566243067	1R12-324	W01-358-9565	23
566243067	1R12-324	W01-358-9565	23
566243067	1R12-324	W01-358-9566	23
566243067	1R12-350	W01-358-9031	30
566243067	1R12-351	W01-358-9033	30
566243067	1R12-359	W01-358-9077	31
566243067	1R12-435	W01-358-9307	33
566243067	1R12-435	W01-358-9334	32
566243067	1R12-487	W01-358-9366	38
566243067	1R12-522	W01-358-8204	34
566243067	1R12-555	W01-358-8961	28
566243067	1R12-557	W01-358-8976	29
566243067	1R12-558	W01-358-8986	30
566243067	1R12-559	W01-358-9029	30
566243067	1R12-560	W01-358-9308	31

GOODYEAR BELLOW NO.	GOODYEAR PART NO.	FIRESTONE AON	PAGE No.
566243067	1R12-561	W01-358-9332	31
566243067	1R12-562	W01-358-8197	33
566243067	1R12-563	W01-358-8934	36
566243067	1R12-566	W01-358-8964	29
566243067	1R12-571	W01-358-9365	38
566243076	1R12-132	W01-358-9105	37
566243076	1R12-132	W01-358-9113	37
566243076	1R12-132	W01-358-9302	37
566243076	1R12-205	W01-358-9568	26
566243076	1R12-325	W01-358-9567	26
566243076	1R12-352	W01-358-9010	41
566243076	1R12-355	W01-358-9078	36
566243076	1R12-367	W01-358-9640	39
566243076	1R12-370	W01-358-9070	42
566243076	1R12-370	W01-358-9336	43
566243076	1R12-370	W01-358-9336	43
566243076	1R12-434	W01-358-8802	39
566243076	1R12-437	W01-358-9797	45
566243076	1R12-445	W01-358-8802	39
566243076	1R12-445	W01-358-8806	40
566243076	1R12-445	W01-358-8806	40
566243076	1R12-505	W01-358-9325	37
566243076	1R12-620	W01-358-9335	43
566243076	1R12-620	W01-358-9335	43
566243080	1R12-373	W01-358-9491	72
566243090	1R12-256	W01-358-9321	63
566243090	1R12-256	W01-358-9367	64
566243090	1R12-256	W01-358-9367	64
566243090	1R12-335	W01-358-9321	63
566243090	1R12-363	W01-358-9320	63
566243090	1R12-440	W01-358-9370	64
566243090	1R12-503	W01-358-9370	64
566243090	1R12-663	W01-358-9320	63
566243097	1R12-402	W01-358-9297	57
566243097	1R12-403	W01-358-9373	57
566243097	1R12-404	W01-358-9375	57
566243097	1R12-405	W01-358-8829	45
566243097	1R12-424	W01-358-9287	56
566243097	1R12-446	W01-358-9245	61
566243097	1R12-481	W01-358-9923	54

Firestone

1T & Convuluted Goodyear Bellow Number to Firestone

GOODYEAR BELLOW NO.	GOODYEAR PART NO.	FIRESTONE AON	PAGE No.
566243097	1R12-498	W01-358-9922	54
566243097	1R12-502	W01-358-9921	54
566243097	1R12-532	W01-358-9935	55
566243097	1R12-533	W01-358-9923	54
566243097	1R12-615	W01-358-8829	45
566243110	1R12-182	W01-358-9219	48
566243110	1R12-405	W01-358-8829	45
566243173	1R12-173	W01-358-9466	52
566243173	1R12-197	W01-358-9466	52
566243173	1R12-365	W01-358-9466	52
566243180	1R12-365	W01-358-9466	52
566243225	1R12-424	W01-358-9287	56
566243275	1R12-186	W01-358-9780	73
566243275	1R12-189	W01-358-9780	73
566243275	1R12-303	W01-358-9780	73
566243275	1R12-603	W01-358-9780	73
566263015	1R13-038	W01-358-9122	88
566263034	1R13-118	W01-358-9580	80
566263036	1R13-077	W01-358-9270	70
566263036	1R13-119	W01-358-9270	70
566263043	1R13-117	W01-358-9275	71
566263044	1R13-115	W01-358-9250	73
566263044	1R13-116	W01-358-9252	73
566263050	1R13-097	W01-358-8723	75
566263050	1R13-109	W01-358-8782	77
566263050	1R13-124	W01-358-8710	79
566263050	1R13-124	W01-358-8755	76
566263051	1R13-039	W01-358-9121	84
566263051	1R13-043	W01-358-9121	84
566263051	1R13-047	W01-358-9144	85
566263051	1R13-049	W01-358-9121	84
566263053	1R13-119	W01-358-9270	70
566263054	1R13-120	W01-358-9218	83
566263055	1R13-130	W01-358-8729	75
566263071	1R13-152	W01-358-8748	77
566263071	1R13-153	W01-358-8749	77
566263072	1R13-048	W01-358-9122	88
566263073	1R13-159	W01-358-8709	79
566263078	1R13-176	W01-358-8713	80
566263080	1R13-177	W01-358-8708	80

GOODYEAR BELLOW NO.	GOODYEAR PART NO.	FIRESTONE AON	PAGE No.
566263144	1R13-144	W01-358-9580	80
566283015	1R14-037	W01-358-9215	82
566283015	1R14-038	W01-358-9200	82
566283015	1R14-039	W01-358-8050	93
566283015	1R14-042	W01-358-8052	94
566283015	1R14-147	W01-358-8053	94
566283015	1R14-171	W01-358-8091	83
566283020	1R14-019	W01-358-9152	89
566283020	1R14-019	W01-358-9152	89
566283020	1R14-019	W01-358-9156	89
566283020	1R14-025	W01-358-9156	89
566283020	1R14-030	W01-358-9158	89
566283020	1R14-031	W01-358-9158	89
566283020	1R14-045	W01-358-8792	88
566283020	1R14-045	W01-358-9122	88
566283020	1R14-174	W01-358-5503	90
566283021	1R14-018	W01-358-9149	85
566283021	1R14-024	W01-358-9149	85
566283021	1R14-026	W01-358-9148	85
566283021	1R14-027	W01-358-9148	85
566283021	1R14-028	W01-358-9177	86
566283021	1R14-028	W01-358-9179	86
566283021	1R14-029	W01-358-9177	86
566283021	1R14-115	W01-358-9961	86
566283021	1R14-137	W01-358-9134	88
566283021	1R14-159	W01-358-9164	85
566283021	1R14-160	W01-358-9144	85
566283023	1R14-055	W01-358-8050	93
566283023	1R14-083	W01-358-8050	93
566283029	1R14-127	W01-358-9264	92
566283030	1R14-113	W01-358-5505	90
566283042	1R14-172	W01-358-8774	84
578913301	1B12-301	W01-358-7009	98
578913301	1B12-305	W01-358-7043	98
578913351	1B14-350	W01-358-7103	99
578913351	1B14-351	W01-358-7104	99
578913352	1B14-358	W01-358-7112	100
578923202	2B9-200	W01-358-6910	104
578923202	2B9-201	W01-358-6902	105
578923202	2B9-201	W01-358-6935	106

Cross References

1T & Convuluted Goodyear Bellow Number to Firestone

GOODYEAR BELLOW NO.	GOODYEAR PART NO.	FIRESTONE AON	PAGE No.
578923202	2B9-201	W01-358-6935	106
578923202	2B9-206	W01-358-6905	105
578923202	2B9-229	W01-358-6897	105
578923202	2B9-230	W01-358-6940	106
578923202	2B9-245	W01-358-7788	107
578923202	2B9-265	W01-358-6941	106
578923206	2B9-210	W01-358-6908	106
578923206	2B9-218	W01-358-6927	109
578923206	2B9-246	W01-358-6944	109
578923206	2B9-250	W01-358-6943	109
578923206	2B9-251	W01-358-6948	110
578923206	2B9-252	W01-358-6944	109
578923206	2B9-253	W01-358-6945	109
578923206	2B9-254	W01-358-6946	110
578923206	2B9-255	W01-358-6947	110
578923208	2B9-352	W01-358-6944	109
578923211	2B9-246	W01-358-6932	106
578923250	2B10-226	W01-358-7795	107
578923309	2B12-300	W01-358-7424	114
578923309	2B12-307	W01-358-7403	112
578923309	2B12-309	W01-358-7400	112
578923309	2B12-313	W01-358-7405	112
578923309	2B12-318	W01-358-7185	111
578923309	2B12-319	W01-358-7409	113
578923309	2B12-320	W01-358-7401	112
578923309	2B12-320	W01-358-7437	114
578923309	2B12-406	W01-358-7410	113
578923309	2B12-410	W01-358-7404	112
578923309	2B12-411	W01-358-7181	111
578923309	2B12-412	W01-358-7183	111
578923309	2B12-425	W01-358-7180	111
578923309	2B12-426	W01-358-7406	113
578923309	2B12-427	W01-358-7429	114
578923309	2B12-432	W01-358-7423	113
578923310	2B12-305	W01-358-7443	114
578923310	2B12-317	W01-358-7499	116
578923310	2B12-324	W01-358-7447	115
578923310	2B12-402	W01-358-7446	115
578923310	2B12-428	W01-358-7473	115
578923310	2B12-434	W01-358-7472	116

GOODYEAR BELLOW NO.	GOODYEAR PART NO.	FIRESTONE AON	PAGE No.
578923310	2B12-446	W01-358-7444	115
578923315	2B12-345	W01-358-7545	116
578923315	2B12-346	W01-358-7550	116
578923315	2B12-416	W01-358-7444	115
578923315	2B12-440	W01-358-7550	116
578923315	2B12-440	W01-358-7555	117
578923353	2B14-354	W01-358-7145	118
578923353	2B14-355	W01-358-7146	118
578923353	2B14-356	W01-358-7136	117
578923353	2B14-359	W01-358-7140	118
578923353	2B14-359	W01-358-7782	120
578923353	2B14-360	W01-358-7135	117
578923353	2B14-366	W01-358-6803	119
578923353	2B14-367	W01-358-7123	117
578923356	2B14-365	W01-358-6801	119
578923356	2B14-383	W01-358-7557	120
578923356	2B14-462	W01-358-6805	119
578923356	2B14-470	W01-358-7782	120
578923356	2B14-476	W01-358-6799	120
578933100	3B12-300	W01-358-8008	124
578933100	3B12-301	W01-358-8010	124
578933100	3B12-303	W01-358-8018	125
578933100	3B12-304	W01-358-8006	124
578933100	3B12-310	W01-358-8027	125
578933100	3B12-312	W01-358-8033	126
578933100	3B12-315	W01-358-8032	125
578933100	3B12-319	W01-358-8032	125
578933100	3B12-328	W01-358-7994	123
578933100	3B12-329	W01-358-7995	123
578933100	3B12-335	W01-358-7996	123
578933103	3B12-322	W01-358-8042	#N/A
578933103	3B12-323	W01-358-8043	127
578933350	3B14-350	W01-358-7808	128
578933350	3B14-354	W01-358-7808	128
578933350	3B14-356	W01-358-7798	127
578933350	3B14-356	W01-358-7838	129
578933350	3B14-359	W01-358-7818	128
578933350	3B14-359	W01-358-7839	129
578933350	3B14-360	W01-358-7800	128
578933350	3B14-360	W01-358-7848	130

Firestone

1T & Convuluted Goodyear Bellow Number to Firestone

GOODYEAR BELLOW NO.	GOODYEAR PART NO.	FIRESTONE AON	PAGE No.
578933350	3B14-364	W01-358-7843	129
578933350	3B14-367	W01-358-7796	127
578933350	3B14-367	W01-358-7796	127
578933350	3B14-367	W01-358-7847	130
579923530	2B8-550	W01-358-7325	103

Cross References

1T & Convuluted Triangle Assembly Number to Firestone

TRIANGLE PART NO.	TRIANGLE BELLOW NO.	FIRESTONE AON	PAGE No.
4310	6325	W01-358-6902	105
4311	6329	W01-358-7135	117
4313	6316	W01-358-7400	112
4315	6325	W01-358-6905	105
4316	6329	W01-358-7140	118
4318	6316	W01-358-7403	112
4320	6325	W01-358-6910	104
4321	6329	W01-358-7136	117
4323	6328	W01-358-7443	114
4325	6319	W01-358-7818	128
4327	6316	W01-358-7424	114
4331	6316	W01-358-7410	113
4333	6319	W01-358-7800	128
4336	6319	W01-358-7808	128
4337	6316	W01-358-7401	112
4339	6326	W01-358-7112	100
4340	6328	W01-358-7447	115
4342	6329	W01-358-7146	118
4343	6316	W01-358-7429	114
4345	6329	W01-358-7123	117
4346	6316	W01-358-7404	112
4361	6326	W01-358-7117	100
4362	6325	W01-358-6908	106
4363	6316	W01-358-7180	111
4364	6316	W01-358-7405	112
4365	6316	W01-358-7406	113
4366	6316	W01-358-7408	113
4367	6316	W01-358-7409	113
4368	6316	W01-358-7423	113
4369	6328	W01-358-7444	115
4370	6328	W01-358-7446	115
4371	6316	W01-358-7437	114
4371	6328	W01-358-7472	116
4372	6328	W01-358-7473	115
4373	6328	W01-358-7483	115
4374	6329	W01-358-7145	118
4413	6334	W01-358-8032	125
4426	6332	W01-358-6943	109
4427	6332	W01-358-6945	109
4428	6332	W01-358-6947	110

TRIANGLE PART NO.	TRIANGLE BELLOW NO.	FIRESTONE AON	PAGE No.
4429	6332	W01-358-6948	110
4430	6334	W01-358-8006	124
4431	6334	W01-358-8008	124
4432	6334	W01-358-8010	124
4433	6334	W01-358-8016	124
4434	6334	W01-358-8018	125
4436	6335	W01-358-7838	129
4437	6335	W01-358-7839	129
4438	6335	W01-358-7844	129
4439	6335	W01-358-7848	130
4441	6335	W01-358-7850	131
4442	6326	W01-358-7103	99
4446	6326	W01-358-7104	99
4447	6326	W01-358-7105	99
4448	6325	W01-358-6941	106
4449	6336	W01-358-6803	119
4450	6325	W01-358-6940	106
4451	6336	W01-358-6801	119
4452	6325	W01-358-6932	106
4453	6332	W01-358-6927	109
4454	6332	W01-358-6944	109
4455	6335	W01-358-7843	129
4456	6335	W01-358-7846	130
4457	6335	W01-358-7847	130
4463	6332	W01-358-6946	110
4466	6334	W01-358-8027	125
4467	6374	W01-358-6994	98
4468	6374	W01-358-7009	98
4469	6334	W01-358-8025	125
4471	6316	W01-358-7183	111
4472	6316	W01-358-7181	111
4474	6374	W01-358-7008	98
4480	6375	W01-358-7550	116
4480	6375	W01-358-7555	117
4498	6334	W01-358-8030	125
4499	6325	W01-358-6935	106
4500	6316	W01-358-7344	111
4502	6328	W01-358-7499	116
4504	6325	W01-358-6926	104
4505	6325	W01-358-6897	105

Firestone

1T & Convuluted Triangle Assembly Number to Firestone

TRIANGLE PART NO.	TRIANGLE BELLOW NO.	FIRESTONE AON	PAGE No.
4506	6325	W01-358-6949	107
4507	6332	W01-358-6960	110
4509	6392	W01-358-7325	103
4510	6325	W01-358-7788	107
4511	6332	W01-358-6962	110
4512	6328	W01-358-6789	114
4513	6328	W01-358-7790	116
4514	6375	W01-358-7545	116
4515	6326	W01-358-7093	99
4516	6326	W01-358-7096	100
4517	6326	W01-358-7088	99
4518	6336	W01-358-6800	119
4519	6336	W01-358-6808	120
4520	6334	W01-358-7996	123
4521	6335	W01-358-7845	130
4522	6335	W01-358-7855	131
4523	6335	W01-358-7859	131
4524	6395	W01-358-7795	107
4525	6319	W01-358-7798	127
4525	6334	W01-358-8033	126
4529	6332	W01-358-6883	108
4530	6412	W01-358-7557	120
4532	6336	W01-358-6805	119
4534	6335	W01-358-7862	131
4535	6319	W01-358-7797	127
4536	6319	W01-358-7796	127
4537	6335	W01-358-7853	131
4539	6325	W01-358-6890	103
4541	6375	W01-358-7550	116
4543	6412	W01-358-6799	120
4544	6412	W01-358-7782	120
4545	6412	W01-358-7781	120
4546	6334	W01-358-7994	123
4547	6334	W01-358-7995	123
4548	6334	W01-358-7998	123
4553	6429	W01-358-8039	126
4554	6429	W01-358-8038	126
8310	6363	W01-358-9082	46
8311	6360	W01-358-9039	31
8312	6362	W01-358-9069	42

TRIANGLE PART NO.	TRIANGLE BELLOW NO.	FIRESTONE AON	PAGE No.
8313	6366	W01-358-8792	88
8313	6366	W01-358-9122	88
8314	6368	W01-358-9422	18
8315	6364	W01-358-9101	60
8316	6365	W01-358-9177	86
8317	6365	W01-358-9121	84
8318	6366	W01-358-9158	89
8319	6361	W01-358-9105	37
8320	6367	W01-358-8050	93
8321	6364	W01-358-9394	62
8322	6372	W01-358-9415	25
8323	6369	W01-358-9275	71
8324	6371	W01-358-9250	73
8325	6363	W01-358-9096	47
8326	6364	W01-358-9192	60
8327	6361	W01-358-9053	36
8328	6360	W01-358-9033	30
8329	6361	W01-358-9078	36
8330	6362	W01-358-9070	42
8331	6360	W01-358-9077	31
8332	6363	W01-358-9093	47
8333	6363	W01-358-9083	46
8334	6368	W01-358-9075	20
8335	6362	W01-358-9059	41
8336	6368	W01-358-9440	21
8337	6372	W01-358-9439	25
8339	6360	W01-358-9031	30
8341	6361	W01-358-9113	37
8342	6361	W01-358-9118	37
8343	6361	W01-358-9302	37
8344	6362	W01-358-9008	41
8345	6362	W01-358-9010	41
8345	6362	W01-358-9063	42
8346	6362	W01-358-9011	41
8348	6362	W01-358-9068	42
8349	6362	W01-358-9071	42
8351	6363	W01-358-9193	47
8352	6363	W01-358-9194	47
8353	6363	W01-358-9227	49
8354	6363	W01-358-9228	49

Cross References

1T & Convuluted Triangle Assembly Number to Firestone

TRIANGLE PART NO.	TRIANGLE BELLOW NO.	FIRESTONE AON	PAGE No.
8355	6364	W01-358-9203	60
8356	6364	W01-358-9238	61
8357	6364	W01-358-9240	61
8358	6364	W01-358-9394	62
8359	6364	W01-358-9350	62
8360	6373	W01-358-9320	63
8361	6373	W01-358-9321	63
8362	6369	W01-358-9274	70
8363	6371	W01-358-9252	73
8364	6365	W01-358-9148	85
8365	6365	W01-358-9149	85
8366	6365	W01-358-9179	86
8367	6365	W01-358-9961	86
8368	6365	W01-358-9135	85
8369	6366	W01-358-9152	89
8370	6366	W01-358-9156	89
8371	6363	W01-358-9256	49
8372	6363	W01-358-9092	47
8373	6363	W01-358-9097	51
8374	6363	W01-358-9098	52
8376	6363	W01-358-9392	50
8377	6365	W01-358-9144	85
8378	6367	W01-358-8052	94
8379	6368	W01-358-9379	24
8380	6367	W01-358-8053	94
8381	6362	W01-358-9798	45
8382	6363	W01-358-9780	73
8383	6364	W01-358-9394	62
8384	6364	W01-358-9243	61
8385	6367	W01-358-8051	94
8388	6365	W01-358-9221	86
8390	6364	W01-358-9245	61
8391	6363	W01-358-9362	50
8392	6363	W01-358-9304	49
8393	6363	W01-358-9026	46
8394	6363	W01-358-9004	46
8395	6361	W01-358-9325	37
8396	6361	W01-358-8930	35
8397	6360	W01-358-9332	31
8398	6360	W01-358-9308	31

TRIANGLE PART NO.	TRIANGLE BELLOW NO.	FIRESTONE AON	PAGE No.
8399	6360	W01-358-9029	30
8400	6360	W01-358-8977	12
8400	6360	W01-358-8986	30
8401	6368	W01-358-8900	19
8405	6365	W01-358-9164	85
8406	6391	W01-358-9287	56
8407	6363	W01-358-9213	48
8408	6363	W01-358-9219	48
8409	6363	W01-358-9223	48
8410	6363	W01-358-9466	52
8413	6377	W01-358-9268	38
8414	6417	W01-358-9215	82
8415	6417	W01-358-9200	82
8416	6363	W01-358-9296	49
8417	6378	W01-358-9295	27
8418	6364	W01-358-9342	54
8419	6417	W01-358-8088	81
8420	6417	W01-358-9277	83
8421	6417	W01-358-9216	82
8422	6417	W01-358-9218	83
8423	6378	W01-358-9294	27
8424	6378	W01-358-9293	27
8425	6378	W01-358-9291	26
8426	6391	W01-358-9902	54
8427	6388	W01-358-9640	39
8428	6391	W01-358-9922	54
8429	6391	W01-358-9923	54
8430	6391	W01-358-9942	55
8431	6383	W01-358-9134	88
8432	6383	W01-358-9138	88
8433	6385	W01-358-9270	70
8434	6386	W01-358-9580	80
8435	6387	W01-358-9265	63
8436	6391	W01-358-9015	27
8436	6391	W01-358-8944	52
8437	6362	W01-358-9070	42
8437	6362	W01-358-9070	42
8438	6364	W01-358-9349	62
8439	6364	W01-358-9348	62
8440	6364	W01-358-9373	57

Firestone

1T & Convuluted Triangle Assembly Number to Firestone

TRIANGLE PART NO.	TRIANGLE BELLOW NO.	FIRESTONE AON	PAGE No.
8441	6363	W01-358-9213	48
8443	6391	W01-358-9921	54
8445	6369	W01-358-9473	71
8446	6389	W01-358-5410	10
8447	6368	W01-358-9378	20
8448	6373	W01-358-9370	64
8449	6363	W01-358-8829	45
8450	6362	W01-358-9568	26
8452	6391	W01-358-9947	55
8453	6390	W01-358-8751	76
8454	6391	W01-358-9936	55
8455	6378	W01-358-8949	26
8456	6363	W01-358-9648	58
8459	6363	W01-358-9210	48
8460	6390	W01-358-8709	79
8461	6362	W01-358-9567	26
8462	6362	W01-358-8805	40
8464	6368	W01-358-8901	19
8465	6362	W01-358-9335	43
8467	6369	W01-358-9472	71
8468	6393	W01-358-9421	67
8469	6362	W01-358-8802	39
8470	6364	W01-358-9346	61
8471	6360	W01-358-9307	33
8472	6364	W01-358-8852	59
8473	6360	W01-358-8963	29
8475	6391	W01-358-9943	55
8476	6391	W01-358-9947	55
8477	6368	W01-358-9376	20
8478	6368	W01-358-9377	20
8479	6368	W01-358-9387	20
8480	6360	W01-358-8964	29
8481	6360	W01-358-9333	31
8482	6360	W01-358-9334	32
8483	6361	W01-358-8201	34
8484	6361	W01-358-8204	34
8485	6361	W01-358-8932	35
8486	6394	W01-358-8749	77
8487	6361	W01-358-9339	38
8488	6361	W01-358-9366	38

TRIANGLE PART NO.	TRIANGLE BELLOW NO.	FIRESTONE AON	PAGE No.
8489	6362	W01-358-8803	39
8490	6362	W01-358-9336	43
8491	6362	W01-358-9467	43
8492	6362	W01-358-9482	43
8493	6362	W01-358-9483	44
8494	6362	W01-358-9484	44
8495	6361	W01-358-9365	38
8496	6362	W01-358-9797	45
8497	6363	W01-358-8924	45
8498	6363	W01-358-8927	46
8499	6363	W01-358-9364	#N/A
8500	6363	W01-358-9474	50
8501	6369	W01-358-9470	71
8502	6369	W01-358-9471	71
8503	6360	W01-358-8976	29
8505	6373	W01-358-9367	64
8506	6417	W01-358-9204	82
8507	6365	W01-358-8778	84
8508	6383	W01-358-8779	87
8509	6383	W01-358-8780	87
8510	6363	W01-358-9944	51
8511	6373	W01-358-9338	64
8512	6363	W01-358-9211	48
8512	6363	W01-358-9388	50
8513	6396	W01-358-8729	75
8514	6397	W01-358-9617	17
8515	6368	W01-358-9616	19
8516	6368	W01-358-9476	22
8517	6372	W01-358-8919	24
8518	6390	W01-358-8752	76
8519	6391	W01-358-9373	57
8519	6391	W01-358-9375	57
8520	6391	W01-358-9297	57
8521	6391	W01-358-9371	57
8522	6390	W01-358-8755	76
8523	6369	W01-358-9275	71
8523	6398	W01-358-8091	83
8525	6379	W01-358-8997	9
8526	6382	W01-358-8708	80
8528	6411	W01-358-8868	12

Cross References

1T & Convuluted Triangle Assembly Number to Firestone

TRIANGLE PART NO.	TRIANGLE BELLOW NO.	FIRESTONE AON	PAGE No.
8529	6410	W01-358-8979	12
8530	6399	W01-358-5503	90
8530	6399	W01-358-5511	91
8533	6382	W01-358-8713	80
8535	6391	W01-358-9948	56
8536	6414	W01-358-8903	53
8537	6362	W01-358-9463	43
8537	6367	W01-358-9622	17
8538	6415	W01-358-9618	18
8538	6415	W01-358-9625	18
8539	6413	W01-358-9264	92
8541	6361	W01-358-8991	36
8542	6360	W01-358-8961	28
8543	6361	W01-358-8203	34
8544	6361	W01-358-8934	36
8545	6362	W01-358-8806	40
8546	6362	W01-358-8810	40
8548	6391	W01-358-9935	55
8549	6363	W01-358-9643	52
8550	6391	W01-358-9647	58
8551	6391	W01-358-9649	58
8552	6364	W01-358-8855	59
8553	6364	W01-358-8856	60
8555	6371	W01-358-9269	73
8556	6365	W01-358-9116	84
8557	6383	W01-358-8781	87
8558	6366	W01-358-9199	89
8559	6389	W01-358-5423	10
8560	6416	W01-358-9896	92
8563	6368	W01-358-9448	21
8564	6421	W01-358-9645	65
8564	6429	W01-358-9646	63
8567	6424	W01-358-9619	28
8568	6524	W01-358-9626	27
8569	6428	W01-358-9644	51
8570	6394	W01-358-8748	77
8571	6369	W01-358-9470	71
8572	6391	W01-358-9471	71
8573	6391	W01-358-9472	71
8574	6391	W01-358-9473	71
8575	6388	W01-358-9634	39

Firestone

1T & Convuluted Triangle Bellow Number to Firestone

TRIANGLE BELLOW NO.	TRIANGLE PART NO.	FIRESTONE AON	PAGE No.
6316	4313	W01-358-7400	112
6316	4318	W01-358-7403	112
6316	4327	W01-358-7424	114
6316	4331	W01-358-7410	113
6316	4337	W01-358-7401	112
6316	4343	W01-358-7429	114
6316	4346	W01-358-7404	112
6316	4363	W01-358-7180	111
6316	4364	W01-358-7405	112
6316	4365	W01-358-7406	113
6316	4366	W01-358-7408	113
6316	4367	W01-358-7409	113
6316	4368	W01-358-7423	113
6316	4371	W01-358-7437	114
6316	4471	W01-358-7183	111
6316	4472	W01-358-7181	111
6316	4500	W01-358-7344	111
6319	4325	W01-358-7818	128
6319	4333	W01-358-7800	128
6319	4336	W01-358-7808	128
6319	4525	W01-358-7798	127
6319	4535	W01-358-7797	127
6319	4536	W01-358-7796	127
6325	4310	W01-358-6902	105
6325	4315	W01-358-6905	105
6325	4320	W01-358-6910	104
6325	4362	W01-358-6908	106
6325	4448	W01-358-6941	106
6325	4450	W01-358-6940	106
6325	4452	W01-358-6932	106
6325	4499	W01-358-6935	106
6325	4504	W01-358-6926	104
6325	4505	W01-358-6897	105
6325	4506	W01-358-6949	107
6325	4510	W01-358-7788	107
6325	4539	W01-358-6890	103
6326	4339	W01-358-7112	100
6326	4361	W01-358-7117	100
6326	4442	W01-358-7103	99
6326	4446	W01-358-7104	99

TRIANGLE BELLOW NO.	TRIANGLE PART NO.	FIRESTONE AON	PAGE No.
6326	4447	W01-358-7105	99
6326	4515	W01-358-7093	99
6326	4516	W01-358-7096	100
6326	4517	W01-358-7088	99
6328	4323	W01-358-7443	114
6328	4340	W01-358-7447	115
6328	4369	W01-358-7444	115
6328	4370	W01-358-7446	115
6328	4371	W01-358-7472	116
6328	4372	W01-358-7473	115
6328	4373	W01-358-7483	115
6328	4502	W01-358-7499	116
6328	4512	W01-358-6789	114
6328	4513	W01-358-7790	116
6329	4311	W01-358-7135	117
6329	4316	W01-358-7140	118
6329	4321	W01-358-7136	117
6329	4342	W01-358-7146	118
6329	4345	W01-358-7123	117
6329	4374	W01-358-7145	118
6332	4426	W01-358-6943	109
6332	4427	W01-358-6945	109
6332	4428	W01-358-6947	110
6332	4429	W01-358-6948	110
6332	4453	W01-358-6927	109
6332	4454	W01-358-6944	109
6332	4463	W01-358-6946	110
6332	4507	W01-358-6960	110
6332	4511	W01-358-6962	110
6332	4529	W01-358-6883	108
6334	4413	W01-358-8032	125
6334	4430	W01-358-8006	124
6334	4431	W01-358-8008	124
6334	4432	W01-358-8010	124
6334	4433	W01-358-8016	124
6334	4434	W01-358-8018	125
6334	4466	W01-358-8027	125
6334	4469	W01-358-8025	125
6334	4498	W01-358-8030	125
6334	4520	W01-358-7996	123

Cross References

1T & Convoluted Triangle Bellow Number to Firestone

TRIANGLE BELLOW NO.	TRIANGLE PART NO.	FIRESTONE AON	PAGE No.
6334	4525	W01-358-8033	126
6334	4546	W01-358-7994	123
6334	4547	W01-358-7995	123
6334	4548	W01-358-7998	123
6335	4436	W01-358-7838	129
6335	4437	W01-358-7839	129
6335	4438	W01-358-7844	129
6335	4439	W01-358-7848	130
6335	4441	W01-358-7850	131
6335	4455	W01-358-7843	129
6335	4456	W01-358-7846	130
6335	4457	W01-358-7847	130
6335	4521	W01-358-7845	130
6335	4522	W01-358-7855	131
6335	4523	W01-358-7859	131
6335	4534	W01-358-7862	131
6335	4537	W01-358-7853	131
6336	4449	W01-358-6803	119
6336	4451	W01-358-6801	119
6336	4518	W01-358-6800	119
6336	4519	W01-358-6808	120
6336	4532	W01-358-6805	119
6360	8311	W01-358-9039	31
6360	8328	W01-358-9033	30
6360	8331	W01-358-9077	31
6360	8339	W01-358-9031	30
6360	8397	W01-358-9332	31
6360	8398	W01-358-9308	31
6360	8399	W01-358-9029	30
6360	8400	W01-358-8977	12
6360	8400	W01-358-8986	30
6360	8471	W01-358-9307	33
6360	8473	W01-358-8963	29
6360	8480	W01-358-8964	29
6360	8481	W01-358-9333	31
6360	8482	W01-358-9334	32
6360	8503	W01-358-8976	29
6360	8542	W01-358-8961	28
6361	8319	W01-358-9105	37
6361	8327	W01-358-9053	36

TRIANGLE BELLOW NO.	TRIANGLE PART NO.	FIRESTONE AON	PAGE No.
6361	8329	W01-358-9078	36
6361	8341	W01-358-9113	37
6361	8342	W01-358-9118	37
6361	8343	W01-358-9302	37
6361	8395	W01-358-9325	37
6361	8396	W01-358-8930	35
6361	8483	W01-358-8201	34
6361	8484	W01-358-8204	34
6361	8485	W01-358-8932	35
6361	8487	W01-358-9339	38
6361	8488	W01-358-9366	38
6361	8495	W01-358-9365	38
6361	8541	W01-358-8991	36
6361	8543	W01-358-8203	34
6361	8544	W01-358-8934	36
6362	8312	W01-358-9069	42
6362	8330	W01-358-9070	42
6362	8335	W01-358-9059	41
6362	8344	W01-358-9008	41
6362	8345	W01-358-9010	41
6362	8345	W01-358-9063	42
6362	8346	W01-358-9011	41
6362	8348	W01-358-9068	42
6362	8349	W01-358-9071	42
6362	8381	W01-358-9798	45
6362	8437	W01-358-9070	42
6362	8437	W01-358-9070	42
6362	8450	W01-358-9568	26
6362	8461	W01-358-9567	26
6362	8462	W01-358-8805	40
6362	8465	W01-358-9335	43
6362	8469	W01-358-8802	39
6362	8489	W01-358-8803	39
6362	8490	W01-358-9336	43
6362	8491	W01-358-9467	43
6362	8492	W01-358-9482	43
6362	8493	W01-358-9483	44
6362	8494	W01-358-9484	44
6362	8496	W01-358-9797	45
6362	8537	W01-358-9463	43

Firestone

1T & Convuluted Triangle Bellow Number to Firestone

TRIANGLE BELLOW NO.	TRIANGLE PART NO.	FIRESTONE AON	PAGE No.
6362	8545	W01-358-8806	40
6362	8546	W01-358-8810	40
6363	8310	W01-358-9082	46
6363	8325	W01-358-9096	47
6363	8332	W01-358-9093	47
6363	8333	W01-358-9083	46
6363	8351	W01-358-9193	47
6363	8352	W01-358-9194	47
6363	8353	W01-358-9227	49
6363	8354	W01-358-9228	49
6363	8371	W01-358-9256	49
6363	8372	W01-358-9092	47
6363	8373	W01-358-9097	51
6363	8374	W01-358-9098	52
6363	8376	W01-358-9392	50
6363	8382	W01-358-9780	73
6363	8391	W01-358-9362	50
6363	8392	W01-358-9304	49
6363	8393	W01-358-9026	46
6363	8394	W01-358-9004	46
6363	8407	W01-358-9213	48
6363	8408	W01-358-9219	48
6363	8409	W01-358-9223	48
6363	8410	W01-358-9466	52
6363	8416	W01-358-9296	49
6363	8441	W01-358-9213	48
6363	8449	W01-358-8829	45
6363	8456	W01-358-9648	58
6363	8459	W01-358-9210	48
6363	8497	W01-358-8924	45
6363	8498	W01-358-8927	46
6363	8499	W01-358-9364	#N/A
6363	8500	W01-358-9474	50
6363	8510	W01-358-9944	51
6363	8512	W01-358-9211	48
6363	8512	W01-358-9388	50
6363	8549	W01-358-9643	52
6364	8315	W01-358-9101	60
6364	8321	W01-358-9394	62
6364	8326	W01-358-9192	60

TRIANGLE BELLOW NO.	TRIANGLE PART NO.	FIRESTONE AON	PAGE No.
6364	8355	W01-358-9203	60
6364	8356	W01-358-9238	61
6364	8357	W01-358-9240	61
6364	8358	W01-358-9394	62
6364	8359	W01-358-9350	62
6364	8383	W01-358-9394	62
6364	8384	W01-358-9243	61
6364	8390	W01-358-9245	61
6364	8418	W01-358-9342	54
6364	8438	W01-358-9349	62
6364	8439	W01-358-9348	62
6364	8440	W01-358-9373	57
6364	8470	W01-358-9346	61
6364	8472	W01-358-8852	59
6364	8552	W01-358-8855	59
6364	8553	W01-358-8856	60
6365	8316	W01-358-9177	86
6365	8317	W01-358-9121	84
6365	8364	W01-358-9148	85
6365	8365	W01-358-9149	85
6365	8366	W01-358-9179	86
6365	8367	W01-358-9961	86
6365	8368	W01-358-9135	85
6365	8377	W01-358-9144	85
6365	8388	W01-358-9221	86
6365	8405	W01-358-9164	85
6365	8507	W01-358-8778	84
6365	8556	W01-358-9116	84
6366	8313	W01-358-8792	88
6366	8313	W01-358-9122	88
6366	8318	W01-358-9158	89
6366	8369	W01-358-9152	89
6366	8370	W01-358-9156	89
6366	8558	W01-358-9199	89
6367	8320	W01-358-8050	93
6367	8378	W01-358-8052	94
6367	8380	W01-358-8053	94
6367	8385	W01-358-8051	94
6367	8537	W01-358-9622	17
6368	8314	W01-358-9422	18

Cross References

1T & Convoluted Triangle Bellow Number to Firestone

TRIANGLE BELLOW NO.	TRIANGLE PART NO.	FIRESTONE AON	PAGE No.
6368	8334	W01-358-9075	20
6368	8336	W01-358-9440	21
6368	8379	W01-358-9379	24
6368	8401	W01-358-8900	19
6368	8447	W01-358-9378	20
6368	8464	W01-358-8901	19
6368	8477	W01-358-9376	20
6368	8478	W01-358-9377	20
6368	8479	W01-358-9387	20
6368	8515	W01-358-9616	19
6368	8516	W01-358-9476	22
6368	8563	W01-358-9448	21
6369	8323	W01-358-9275	71
6369	8362	W01-358-9274	70
6369	8445	W01-358-9473	71
6369	8467	W01-358-9472	71
6369	8501	W01-358-9470	71
6369	8502	W01-358-9471	71
6369	8523	W01-358-9275	71
6369	8571	W01-358-9470	71
6371	8324	W01-358-9250	73
6371	8363	W01-358-9252	73
6371	8555	W01-358-9269	73
6372	8322	W01-358-9415	25
6372	8337	W01-358-9439	25
6372	8517	W01-358-8919	24
6373	8360	W01-358-9320	63
6373	8361	W01-358-9321	63
6373	8448	W01-358-9370	64
6373	8505	W01-358-9367	64
6373	8511	W01-358-9338	64
6374	4467	W01-358-6994	98
6374	4468	W01-358-7009	98
6374	4474	W01-358-7008	98
6375	4480	W01-358-7550	116
6375	4480	W01-358-7555	117
6375	4514	W01-358-7545	116
6375	4541	W01-358-7550	116
6377	8413	W01-358-9268	38
6378	8417	W01-358-9295	27

TRIANGLE BELLOW NO.	TRIANGLE PART NO.	FIRESTONE AON	PAGE No.
6378	8423	W01-358-9294	27
6378	8424	W01-358-9293	27
6378	8425	W01-358-9291	26
6378	8455	W01-358-8949	26
6379	8525	W01-358-8997	9
6382	8526	W01-358-8708	80
6382	8533	W01-358-8713	80
6383	8431	W01-358-9134	88
6383	8432	W01-358-9138	88
6383	8508	W01-358-8779	87
6383	8509	W01-358-8780	87
6383	8557	W01-358-8781	87
6385	8433	W01-358-9270	70
6386	8434	W01-358-9580	80
6387	8435	W01-358-9265	63
6388	8427	W01-358-9640	39
6388	8575	W01-358-9634	39
6389	8446	W01-358-5410	10
6389	8559	W01-358-5423	10
6390	8453	W01-358-8751	76
6390	8460	W01-358-8709	79
6390	8518	W01-358-8752	76
6390	8522	W01-358-8755	76
6391	8406	W01-358-9287	56
6391	8426	W01-358-9902	54
6391	8428	W01-358-9922	54
6391	8429	W01-358-9923	54
6391	8430	W01-358-9942	55
6391	8436	W01-358-9015	27
6391	8436	W01-358-8944	52
6391	8443	W01-358-9921	54
6391	8452	W01-358-9947	55
6391	8454	W01-358-9936	55
6391	8475	W01-358-9943	55
6391	8476	W01-358-9947	55
6391	8519	W01-358-9373	57
6391	8519	W01-358-9375	57
6391	8520	W01-358-9297	57
6391	8521	W01-358-9371	57
6391	8535	W01-358-9948	56

Firestone

1T & Convuluted Triangle Bellow Number to Firestone

TRIANGLE BELLOW NO.	TRIANGLE PART NO.	FIRESTONE AON	PAGE No.
6391	8548	W01-358-9935	55
6391	8550	W01-358-9647	58
6391	8551	W01-358-9649	58
6391	8572	W01-358-9471	71
6391	8573	W01-358-9472	71
6391	8574	W01-358-9473	71
6392	4509	W01-358-7325	103
6393	8468	W01-358-9421	67
6394	8486	W01-358-8749	77
6394	8570	W01-358-8748	77
6395	4524	W01-358-7795	107
6396	8513	W01-358-8729	75
6397	8514	W01-358-9617	17
6398	8523	W01-358-8091	83
6399	8530	W01-358-5503	90
6399	8530	W01-358-5511	91
6410	8529	W01-358-8979	12
6411	8528	W01-358-8868	12
6412	4530	W01-358-7557	120
6412	4543	W01-358-6799	120
6412	4544	W01-358-7782	120
6412	4545	W01-358-7781	120
6413	8539	W01-358-9264	92
6414	8536	W01-358-8903	53
6415	8538	W01-358-9618	18
6415	8538	W01-358-9625	18
6416	8560	W01-358-9896	92
6417	8414	W01-358-9215	82
6417	8415	W01-358-9200	82
6417	8419	W01-358-8088	81
6417	8420	W01-358-9277	83
6417	8421	W01-358-9216	82
6417	8422	W01-358-9218	83
6417	8506	W01-358-9204	82
6421	8564	W01-358-9645	65
6424	8567	W01-358-9619	28
6428	8569	W01-358-9644	51
6429	4553	W01-358-8039	126
6429	4554	W01-358-8038	126
6429	8564	W01-358-9646	63
6524	8568	W01-358-9626	27

Cross References

1T & Convuluted Contitech Assembly Number to Firestone

CONTI PART NO.	FIRESTONE PART NO.	Page No.
8 10-10 P 481	W01-358-9333	31
9 10.17.5 P 456	W01-358-9648	58
9 10.17.5 P 536	W01-358-8901	19
9 10-10 P 311	W01-358-9039	31
9 10-10 P 328	W01-358-9033	30
9 10-10 P 331	W01-358-9077	31
9 10-10 P 339	W01-358-9031	30
9 10-10 P 397	W01-358-9332	31
9 10-10 P 398	W01-358-9308	31
9 10-10 P 399	W01-358-9029	30
9 10-10 P 400	W01-358-8986	30
9 10-10 P 465	W01-358-9335	43
9 10-10 P 471	W01-358-9307	33
9 10-10 P 473	W01-358-8963	29
9 10-10 P 480	W01-358-8964	29
9 10-10 P 482	W01-358-9334	32
9 10-10 P 503	W01-358-8976	29
9 10-10 P 542	W01-358-8961	28
9 10-12 A 319	W01-358-9105	37
9 10-12 A 327	W01-358-9053	36
9 10-12 A 329	W01-358-9078	36
9 10-12 A 341	W01-358-9113	37
9 10-12 A 342	W01-358-9118	37
9 10-12 A 343	W01-358-9302	37
9 10-12 A 427	W01-358-9640	39
9 10-12 A 488	W01-358-9366	38
9 10-12 A 543	W01-358-8093	87
9 10-12 P 395	W01-358-8927	46
9 10-12 P 395	W01-358-9325	37
9 10-12 P 396	W01-358-8930	35
9 10-12 P 483	W01-358-8203	34
9 10-12 P 484	W01-358-8201	34
9 10-12 P 484	W01-358-8204	34
9 10-12 P 487	W01-358-9339	38
9 10-12 P 495	W01-358-9365	38
9 10-12 P 544	W01-358-8934	36
9 10-12 P 720	W01-358-7667	33
9 10-13.5 S 433	W01-358-9270	70
9 10-14 A 330	W01-358-9070	42
9 10-14 A 381	W01-358-9798	45

CONTI PART NO.	FIRESTONE PART NO.	Page No.
9 10-14 A 437	W01-358-9463	43
9 10-14 A 469	W01-358-8802	39
9 10-14 A 491	W01-358-9467	43
9 10-14 A 492	W01-358-9482	43
9 10-14 A 496	W01-358-9797	45
9 10-14 A 546	W01-358-8810	40
9 10-14 A 575	W01-358-9634	39
9 10-14 A545	W01-358-8806	40
9 10-14 P 312	W01-358-9069	42
9 10-14 P 335	W01-358-9059	41
9 10-14 P 344	W01-358-9008	41
9 10-14 P 345	W01-358-9010	41
9 10-14 P 346	W01-358-9011	41
9 10-14 P 347	W01-358-9063	42
9 10-14 P 348	W01-358-9068	42
9 10-14 P 349	W01-358-9071	42
9 10-14 P 450	W01-358-9568	26
9 10-14 P 461	W01-358-9567	26
9 10-14 P 462	W01-358-8805	40
9 10-14 P 489	W01-358-8803	39
9 10-14 P 493	W01-358-9483	44
9 10-14 P 494	W01-358-9484	44
9 10-14 P 577	W01-358-8813	40
9 10-14 P 718	W01-358-9507	44
9 10-16 A 354	W01-358-9228	49
9 10-16 P 310	W01-358-9082	46
9 10-16 P 325	W01-358-9096	47
9 10-16 P 332	W01-358-9093	47
9 10-16 P 333	W01-358-9083	46
9 10-16 P 351	W01-358-9193	47
9 10-16 P 352	W01-358-9194	47
9 10-16 P 353	W01-358-9227	49
9 10-16 P 371	W01-358-9256	49
9 10-16 P 372	W01-358-9092	47
9 10-16 P 376	W01-358-9392	50
9 10-16 P 392	W01-358-9304	49
9 10-16 P 393	W01-358-9026	46
9 10-16 P 394	W01-358-9004	46
9 10-16 P 409	W01-358-9223	48
9 10-16 P 416	W01-358-9296	49

Firestone

1T & Convuluted Contitech Assembly Number to Firestone

CONTI PART NO.	FIRESTONE PART NO.	Page No.
9 10-16 P 441	W01-358-9213	48
9 10-16 P 441	W01-358-9219	48
9 10-16 P 449	W01-358-8829	45
9 10-16 P 497	W01-358-8919	24
9 10-16 P 498	W01-358-8924	45
9 10-16 P 500	W01-358-9474	50
9 10-16 P 510	W01-358-9944	51
9 10-16 P 547	W01-358-9496	50
9 10-16 P 549	W01-358-9643	52
9 10-16 P 710	W01-358-9299	52
9 10-17.5 A 535	W01-358-9948	56
9 10-17.5 P 406	W01-358-9287	56
9 10-17.5 P 418	W01-358-9342	54
9 10-17.5 P 426	W01-358-9902	54
9 10-17.5 P 429	W01-358-9923	54
9 10-17.5 P 430	W01-358-9942	55
9 10-17.5 P 436	W01-358-8944	52
9 10-17.5 P 436	W01-358-9015	27
9 10-17.5 P 440	W01-358-9375	57
9 10-17.5 P 443	W01-358-9921	54
9 10-17.5 P 445	W01-358-9473	71
9 10-17.5 P 451	W01-358-9376	20
9 10-17.5 P 452	W01-358-9947	55
9 10-17.5 P 454	W01-358-9936	55
9 10-17.5 P 467	W01-358-9472	71
9 10-17.5 P 475	W01-358-9943	55
9 10-17.5 P 501	W01-358-9470	71
9 10-17.5 P 502	W01-358-9471	71
9 10-17.5 P 519	W01-358-9373	57
9 10-17.5 P 519	W01-358-9373	57
9 10-17.5 P 520	W01-358-9297	57
9 10-17.5 P 521	W01-358-9371	57
9 10-17.5 P 548	W01-358-9935	55
9 10-17.5 P 550	W01-358-9647	58
9 10-17.5 P 551	W01-358-9649	58
9 10-17.5 P 731	W01-358-9966	51
9 10-17.5 P 732	W01-358-9947	55
9 10-17.5 P 733	W01-358-9223	48
9 10-17.5 P 779	W01-358-6258	72
9 10-17.5 P 831	W01-358-6262	53

CONTI PART NO.	FIRESTONE PART NO.	Page No.
9 10-17.5 P428	W01-358-9922	54
9 10-19 A 358	W01-358-9394	62
9 10-19 P 315	W01-358-9101	60
9 10-19 P 326	W01-358-9192	60
9 10-19 P 355	W01-358-9203	60
9 10-19 P 356	W01-358-9238	61
9 10-19 P 357	W01-358-9240	61
9 10-19 P 358	W01-358-9394	62
9 10-19 P 359	W01-358-9350	62
9 10-19 P 383	W01-358-9394	62
9 10-19 P 384	W01-358-9243	61
9 10-19 P 390	W01-358-9245	61
9 10-19 P 391	W01-358-9362	50
9 10-19 P 435	W01-358-9265	63
9 10-19 P 438	W01-358-9349	62
9 10-19 P 439	W01-358-9348	62
9 10-19 P 470	W01-358-9346	61
9 10-19 P 472	W01-358-8852	59
9 10-19 P 552	W01-358-8855	59
9 10-19 P 553	W01-358-8856	60
9 10-19 P 765	W01-358-8842	59
9 10-21 A 361	W01-358-9321	63
9 10-21 A 505	W01-358-9367	64
9 10-21 P 360	W01-358-9320	63
9 10-21 P 361	W01-358-9321	63
9 10-21 P 448	W01-358-9370	64
9 10-21 P 505	W01-358-9367	64
9 10-21 P 511	W01-358-9338	64
9 10B-17.5 A 323	W01-358-9275	71
9 10B-17.5 A 362	W01-358-9274	70
9 10B-17.5 P 554	W01-358-9491	72
9 10BP-16 P 569	W01-358-9644	51
9 10BP-20 P 738	W01-358-9646	63
9 10BP-22 P 739	W01-358-9645	65
9 10D-21 A 324	W01-358-9250	73
9 10D-21 A 363	W01-358-9252	73
9 10D-21 A 555	W01-358-9269	73
9 10S-16 A 382	W01-358-9780	73
9 10S-16 A 382	W01-358-9781	73
9 9-10 S 538	W01-358-9625	18

Cross References

1T & Convolutd Contitech Assembly Number to Firestone

CONTI PART NO.	FIRESTONE PART NO.	Page No.
9 9-10 S 576	W01-358-9675	18
9 9-10 S 861	W01-358-9541	17
9 9-10 S 862	W01-358-9618	18
9 9-12 A 334	W01-358-9075	20
9 9-12 A 464	W01-358-8900	19
9 9-12 P 314	W01-358-9422	18
9 9-12 P 379	W01-358-9379	24
9 9-12 P 447	W01-358-9378	20
9 9-12 P 478	W01-358-9377	20
9 9-12 P 479	W01-358-9387	20
9 9-12 P 515	W01-358-9616	19
9 9-12 P 516	W01-358-9476	22
9 9-12 P 563	W01-358-9448	21
9 9-12 P 705	W01-358-9421	67
9 9-14 A 337	W01-358-9439	25
9 9-14 A 517	W01-358-8903	53
9 9-16 P 568	W01-358-9626	27
9 95-15 A 455	W01-358-8949	26
9 9-9 P 756	W01-358-9651	66
9 9-9 P 767	W01-358-5789	68
9 9-9 S 537	W01-358-9622	17
9 9-9 S 859	W01-358-9547	17
9 9-9 S 860	W01-358-9617	17
9 9B-20 P 740	W01-358-9621	28
9 9B-22 P 741	W01-358-9619	28
9 9K-12 P 780	W01-358-9681	23
9 9K-15 P 417	W01-358-9295	27
9 9K-15 P 424	W01-358-9293	27
9 9K-15 P423	W01-358-9294	27
9 9K-15 P425	W01-358-9291	26
9-10-12 P 485	W01-358-8932	35
9-10-14 A 490	W01-358-9336	43
10 10.5-15 P 460	W01-358-8709	79
10 10-15 P 453	W01-358-8751	76
10 10-15 S 518	W01-358-8752	76
10 10-15 S 522	W01-358-8755	76
10 10-15 S 711	W01-358-8710	79
10 10-15 S 711	W01-358-8756	76
10 10-15 S 713	W01-358-8753	76
10 10-16 S 533	W01-358-8713	80

CONTI PART NO.	FIRESTONE PART NO.	Page No.
10 10-21 P 486	W01-358-8749	77
10 10-21 P 494	W01-358-9580	80
10 1021 P 570	W01-358-8748	77
10 10-21 P 774	W01-358-8746	77
10 10B-13 S 513	W01-358-8729	75
10 10-15 S 773	W01-358-8740	75
10 10-16 S 526	W01-358-8708	80
11 10.5 17 A 377	W01-358-9144	85
11 10.5-15 A 414	W01-358-9215	82
11 10.5-15 A 415	W01-358-9200	82
11 10.5-15 A 419	W01-358-8052	94
11 10.5-15 A 420	W01-358-9277	83
11 10.5-15 A 421	W01-358-9216	82
11 10.5-15 A 422	W01-358-9218	83
11 10.5-15 A 506	W01-358-9204	82
11 10.5-17 A 316	W01-358-9177	86
11 10.5-17 A 316	W01-358-9179	86
11 10.5-17 A 317	W01-358-9121	84
11 10.5-17 A 364	W01-358-9148	85
11 10.5-17 A 365	W01-358-9149	85
11 10.5-17 A 366	W01-358-9179	86
11 10.5-17 A 367	W01-358-9961	86
11 10.5-17 A 368	W01-358-9135	85
11 10.5-17 A 388	W01-358-9221	86
11 10.5-17 A 405	W01-358-9164	85
11 10.5-17 A 507	W01-358-8778	84
11 10.5-17 A 556	W01-358-9116	84
11 10.5-19 A 321	W01-358-9138	88
11 10.5-19 A 431	W01-358-9134	88
11 10.5-19 A 508	W01-358-8779	87
11 10.5-19 A 509	W01-358-8780	87
11 10.5-19 A 557	W01-358-8781	87
11 10.521 A 313	W01-358-8792	88
11 10.5-21 A 313	W01-358-9122	88
11 10.5-21 A 318	W01-358-9152	89
11 10.5-21 A 318	W01-358-9158	89
11 10.5-21 A 370	W01-358-9156	89
11 10.5-21 A 558	W01-358-9199	89
11 10.5-22 A 530	W01-358-5503	90
11 10.5-22 A 530	W01-358-5511	91

Firestone

1T & Convuluted Contitech Assembly Number to Firestone

CONTI PART NO.	FIRESTONE PART NO.	Page No.
11 10.5-22 S 712	W01-358-9264	92
11 10.5-22 S 750	W01-358-5505	90
11 10.5A-16 P 523	W01-358-8053	94
11 10.5B-18 P743	W01-358-8088	81
11 10.5C-16 A 320	W01-358-8050	96
11 10.5C-16 A 380	W01-358-8051	94
11 10.5F-17 P 745	W01-358-8774	84
FD 120-20 509	W01-358-7325	103
FD 120-20 715	W01-358-7705	103
FD 200-19 310	W01-358-6902	105
FD 200-19 315	W01-358-6905	105
FD 200-19 319	W01-358-6900	104
FD 200-19 320	W01-358-6910	104
FD 200-19 362	W01-358-6908	106
FD 200-19 448	W01-358-6941	106
FD 200-19 450	W01-358-6940	106
FD 200-19 452	W01-358-6932	106
FD 200-19 452	W01-358-7686	107
FD 200-19 499	W01-358-6856	104
FD 200-19 499	W01-358-6935	106
FD 200-19 504	W01-358-6926	104
FD 200-19 505	W01-358-6897	105
FD 200-19 506	W01-358-6949	107
FD 200-19 539	W01-358-6890	103
FD 200-19 724	W01-358-6884	105
FD 200-22 524	W01-358-7795	107
FD 200-22 529	W01-358-6883	108
FD 200-22 706	W01-358-6886	108
FD 200-25 426	W01-358-6943	109
FD 200-25 427	W01-358-6945	109
FD 200-25 428	W01-358-6947	110
FD 200-25 429	W01-358-6948	110
FD 200-25 453	W01-358-6927	109
FD 200-25 454	W01-358-6944	109
FD 200-25 463	W01-358-6946	110
FD 200-25 507	W01-358-6960	110
FD 200-25 511	W01-358-6962	110
FD 330-22 313	W01-358-7400	112
FD 330-22 318	W01-358-7403	112
FD 330-22 327	W01-358-7424	114

CONTI PART NO.	FIRESTONE PART NO.	Page No.
FD 330-22 331	W01-358-7410	113
FD 330-22 334	W01-358-7437	114
FD 330-22 337	W01-358-7401	112
FD 330-22 343	W01-358-7429	114
FD 330-22 346	W01-358-7404	112
FD 330-22 363	W01-358-7180	111
FD 330-22 364	W01-358-7405	112
FD 330-22 366	W01-358-7408	113
FD 330-22 367	W01-358-7409	113
FD 330-22 368	W01-358-7423	113
FD 330-22 471	W01-358-7183	111
FD 330-22 472	W01-358-7181	111
FD 330-22 500	W01-358-7344	111
FD 330-22365	W01-358-7406	113
FD 330-30 323	W01-358-7443	114
FD 330-30 340	W01-358-7447	115
FD 330-30 369	W01-358-7444	115
FD 330-30 370	W01-358-7446	115
FD 330-30 371	W01-358-7472	116
FD 330-30 372	W01-358-7473	115
FD 330-30 373	W01-358-7483	115
FD 330-30 502	W01-358-7499	116
FD 330-30 512	W01-358-6789	114
FD 330-30-513	W01-358-7790	116
FD 331-26 480	W01-358-7555	117
FD 331-26 514	W01-358-7545	116
FD 331-26 541	W01-358-7550	116
FD 530-22 311	W01-358-7135	117
FD 530-22 316	W01-358-7140	118
FD 530-22 321	W01-358-7136	117
FD 530-22 342	W01-358-7146	118
FD 530-22 345	W01-358-7123	117
FD 530-22 374	W01-358-7145	118
FD 530-30 449	W01-358-6803	119
FD 530-30 451	W01-358-6801	119
FD 530-30 518	W01-358-6800	119
FD 530-30 519	W01-358-6808	120
FD 530-30 532	W01-358-6805	119
FD 530-35 530	W01-358-7557	120
FD 530-35 543	W01-358-6799	120

Cross References

1T & Convuluted Contitech Assembly Number to Firestone

CONTI PART NO.	FIRESTONE PART NO.	Page No.
FD 530-35-510	W01-358-7788	107
FD 530-35-544	W01-358-7782	120
FD 530-35-545	W01-358-7781	120
FS 330-11 467	W01-358-6994	98
FS 330-11 468	W01-358-7009	98
FS 330-11 474	W01-358-7008	98
FS 530-14 339	W01-358-7112	100
FS 530-14 442	W01-358-7103	99
FS 530-14 446	W01-358-7104	99
FS 530-14 447	W01-358-7105	99
FS 530-14 515	W01-358-7093	99
FS 530-14 516	W01-358-7096	100
FS 530-14 517	W01-358-7088	99
FS 530-14 538	W01-358-7094	100
FT 330-29 430	W01-358-8006	124
FT 330-29 431	W01-358-8008	124
FT 330-29 432	W01-358-8010	124
FT 330-29 433	W01-358-8016	124
FT 330-29 466	W01-358-8027	125
FT 330-29 469	W01-358-8025	125
FT 330-29 494	W01-358-8018	125
FT 330-29 498	W01-358-8030	125
FT 330-29 525	W01-358-8033	126
FT 330-29 546	W01-358-7994	123
FT 330-29 547	W01-358-7995	123
FT 330-29 548	W01-358-7998	123
FT 530-32 325	W01-358-7818	128
FT 530-32 329	W01-358-7798	127
FT 530-32 336	W01-358-7808	128
FT 530-32 535	W01-358-7797	127
FT 530-32 536	W01-358-7796	127
FT 530-32-333	W01-358-7800	128
FT 530-35 436	W01-358-7838	129
FT 530-35 437	W01-358-7839	129
FT 530-35 438	W01-358-7844	129
FT 530-35 439	W01-358-7848	130
FT 530-35 441	W01-358-7850	131
FT 530-35 455	W01-358-7843	129
FT 530-35 456	W01-358-7846	130
FT 530-35 457	W01-358-7847	130

CONTI PART NO.	FIRESTONE PART NO.	Page No.
FT 530-35 521	W01-358-7845	130
FT 530-35 522	W01-358-7855	131
FT 530-35 523	W01-358-7859	131
FT 530-35 534	W01-358-7862	131
FT 530-35 537	W01-358-7853	131
FT330-29413	W01-358-8032	125
SK 68-10 P01	W21-760-9001	153
SK 68-15 P01	W21-760-9000	153
SZ 70-5060 P02	W02-358-7046	136
SZ 70-5067	W01-358-9651	66
SZ 70-5075 P02	W02-358-7100	130
SZ 70-7065 P02	W02-358-7092	151
SZ 70-7077	W02-358-7075	144
SZ 70-7077 P02	W02-358-7103	144
SZ 70-8077	W02-358-7064	148
SZ 70-8082	W02-358-7082	149
SZ 70-9065 P02	W02-358-7152	151
SZ 70-9087	W02-358-7092	151
SZ70-8077 P02	W02-358-7108	148

Firestone

1T & Convoluted Bellows Index by Bellows Number

BELLOWS NO.	PAGE NO.
1T-REVERSIBLE SLEEVE	
1T14C-1	7, 8
1T14CB-1	8, 9
1T14C-3	9 - 11
1T14C-5	11, 12
1T14C-6	12
1T14C-7	13
1T14C-8	13
1T15AA-3	13
1T15LP-3	14
1T15AA-3	14
1T15LP-3	14, 15
1T15AA-3	15
1T15LP-3	15, 16
1T15S-6	16
1T15LP-3	16
1T15LP-3	16
1T15AA-6	16
1T15CCR-6	17
1T15LA-(-1)	17
1T15LA-0	17, 18
1T15L-1.5	18, 19
1T15LP-1.5	19
1T15L-2	19 - 22
1T15LP-2	22, 23
1T15LC-2.5	23, 24
1T15L-3	24
1T15L-4	24 - 26
1T15LC-4.5	26
1T15LP-5	26, 27
1T15L-6	27
1T15LP-6	27
1T15L-9	28
1T15LB-10	28
1T15LC-12	28
1T15M-0	28 - 32
1T15M-1	32, 33
1T15M-2	33 - 38
1T15MR-2	38
1T15MT-3	39

BELLOWS NO.	PAGE NO.
1T-REVERSIBLE SLEEVE	
1T15M-4	39 - 45
1T15M-6	45, 46
1T15M-6	46 - 51
1T15MBTW-6	51
1T15MJ-6	51, 52
1T15M-6	52
1T15MT-6	52
1T15MW-6	52
1T15MLW-7	52, 53
1T15M-7.5	53 - 56
1T15M-8	56 - 59
1T15M-9	59 - 63
1T15MM-9	63
1T15MBTW-10	63
1T15M-11	63 - 65
1T15MBTW-12	65
1T15SN-3	65
1T15T-1	65 - 67
1T15TQ-1	67 - 69
1T15T-2	69
1T15V-1	69
1T15V-3	70
1T15V-3	70
1T15VP-4	70
1T15V-8	70 - 72
1T15VMW-8	72
1T15V-11	73
1T15ZR-6	73 - 74
BRACKET	74
1T17AZR-4.5	75
1T17AEZR-5	75
1T17BB-2	75
1T17B-5	75 - 77
1T17B-11	77
1T17BP-17	78
1T17C-3	78
1T17CA-3	79
1T17CD-3	79
1T17CA-5	79

Cross References

1T & Convoluted Bellows Index by Bellows Number

BELLOWS NO.	PAGE NO.
1T-REVERSIBLE SLEEVE	
1T17CL-5	79
1T17CA-6.5	79, 80
1T17CA-6	80
1T17C-8	80
1T17CL-9.5	80, 81
1T19L-3	81
1T19L-5	81 - 83
1T19LC-5	83
1T19LC-6	83
1T19LF-7	84
1T19L-7	84 - 86
1T19LC-8	87
1T19LE-8	87
1T19L-9	87, 88
1T19L-11	88 - 90
1T19L-12	90 - 91
1T19L-14	92
1T19L-16	92
1Y19LE-8	93
1T19J-1	93
1T19N-9	93
1T19ZK-5.7	93, 94
1T66E-11.8	94
SINGLE CONVOLUTED	
113-1X88-1	98
19B	98
19B-.75	98
113B	99
113B-.5	99
113B-1	99, 100
126B	100
150B	101
DOUBLE CONVOLUTED	
25C	101
255C-1.5	101
224C	102
264C	102
26C	102, 103
20CT	103, 104

BELLOWS NO.	PAGE NO.
DOUBLE CONVOLUTED	
20F	104 - 107
20F-1	108
20F-2	108 - 110
22C	111 - 114
22C-1.5	114 - 116
228CT-1.5	116
228C-1.5	116
252C	117
21D	117, 118
21C	118
205C	118, 119
21CT-2	119
21D-2	119, 120
233D-2	120
256D-2	121
28C	121
201C	121
203C	122
218C	122
29C	122
215C	122
TRIPLE CONVOLUTED	
38D	123 - 126
354D	126
352D	126, 127
352C	126, 127
313D	127, 128
39D	128
333C	129 - 132
312C	132
323C	132
320C	133
321C	133

Firestone

1T & Convuluted Bellows Index by Size

BELLOWS NO.	PAGE NO.
1T-REVERSIBLE SLEEVE	
6.31" Dia. Bead Plate, 6.62" Molded Dia.	
1T14C-1	7, 8
1T14C-3	9 - 11
1T14C-5	11, 12
1T14C-6	12
1T14C-7	13
1T14C-8	13
9.00" Dia. Bead Plate, 7.75" Molded Dia.	
1T15S-5 or 1T15AA-3	15
1T15S-6 or 1T15AA-3	15
1T15SN-3	65
1T15SN-6	
1T15T-1	65 - 67
1T15TM-1	
1T15TQ-1	67 - 69
1T15T-2	69
9.00" Dia. Bead Plate, 9.12" Molded Dia.	
1T15AA-3	13
1T15AA-6	16
1T15LA-(-1) 1T15KW- (-1)	17
1T15LA-0 1T15KW-0	17, 18
1T15-L-1.5	18, 19
1T15L-1.5	18, 19
1T15LP-1.5	19
1T15L-2	19 - 22
1T15LP-2	22, 23
1T15LC-2.5	23, 24
1T15L-3	24
1T15L-4	24 - 26
1T15LC-4.5	26
1T15LP-5	26, 27
1T15L-6	27
1T15LP-6	27
1T15L-9	28
1T15LB-10	28
1T15LC-12	28

BELLOWS NO.	PAGE NO.
1T-REVERSIBLE SLEEVE	
9.00" Dia. Bead Plate, 10.12" Molded Dia.	
1T15M-0	28 - 32
1T15M-2	33 - 38
1T15MR-2	38
1T15MT-3	39
1T15M-4	39 - 45
1T15M-6	45, 46
1T15MBTW-6	
1T15MJ-6	51, 52
1T15MT-6	52
1T15MW-6	52
1T15MLW-7	52, 53
1T15M-7.5	53 - 56
1T15M-8	56 - 59
1T15M-9	59 - 63
1T15MM-9	63
1T15MBTW-10	
1T15M-11	63 - 65
1T15MBTW-12	65
1T15V-1	69
1T15V-3	70
1T15VP-4	70
1T15V-8	70 - 72
1T15VMW-8	72
1T15V-11	73
9.00" Dia. Bead Plate, 10.62" Molded Dia.	
1T15ZR-6	73 - 74
10.38" Dia. Bead Plate, 10.12" Molded Dia.	
1T17AZR-4.5	75
1T17AEZR-5	75
1T17BB-2	75
1T17B-5	75 - 77
1T17B-11	77
1T17BP-17	78
1T17C-3	78
1T17CA-3	79

Cross References

1T & Convoluted Bellows Index by Size

BELLOWS NO.	PAGE NO.
1T-REVERSIBLE SLEEVE	
10.38" Dia. Bead Plate, 10.12" Molded Dia.	
1T17CD-3	79
1T17CA-5	79
1T17CL-5	79
1T17CA-6	80
1T17CA-6.5	79, 80
1T17C-8	80
11.31" Dia. Bead Plate, 10.62" Molded Dia.	
1T19F-3 or 1T19L-3	81
1T19F-5 or 1T19L-5	81 - 83
1T19L-5	81 - 83
1T19LC-5	83
1T19FC-6 or 1T19LC-6	83
1T19LF-7	84
1T19F-7 or 1T19L-7	84 - 86
1T19FC-8 or 1T19LC-8	87
1T19LE-8	87
1T19F-9 or 1T19L-9	87, 88
1T19F-11 or 1T19L-11	88 - 90
1T19F-12 or 1T19L-12	90, 91
1T19F-14 or 1T19L-14	92
1T19F-16 or 1T19L-16	92
1T19LE-8	87
1T19J-1	93
1T19N-9 or 1T19L-9	87, 88
1T19ZK-5.7	93, 94
12.21" Dia. Bead Plate, 12.62" Molded Dia.	
1T66E-11.8	94
SINGLE CONVOLUTED	
11.31" Dia. Bead Plate, 14.12" Molded Dia.	
113-1X88-1	98
9.00" Dia. Bead Plate, 12.00" Molded Dia.	
19B	98
19B-.75	98

BELLOWS NO.	PAGE NO.
SINGLE CONVOLUTED	
11.31" Dia. Bead Plate, 14.12" Molded Dia.	
113B	99
113B-.5	99
113B-1	99, 100
19.00" Dia. Bead Plate, 21.50" Molded Dia.	
126B	100
6.31" Dia. Bead Plate, 8.88" Molded Dia.	
150B	101
DOUBLE CONVOLUTED	
25C	101
255C-1.5	101
5.31" Dia. Bead Plate, 7.25" Molded Dia.	
224C	102
264C	102
26C	102, 103
20CT	103, 104
20F	104 - 107
20F-1	108
20F-2	108 - 110
9.00" Dia. Bead Plate, 12.00" Molded Dia.	
22C	111 - 114
22C-1.5	114 - 116
228CT-1.5	116
228C-1.5	116
10.38" Dia. Bead Plate, 12.00" Molded Dia.	
252C	117
11.31" Dia. Bead Plate, 14.5" Molded Dia.	
21D	117, 118
21C	118
205C	118, 119
21CT-2	119
21D-2	119, 120
233D-2	120
256D-2	121

Firestone

1T & Convoluted Bellows Index by Size

BELLOWS NO.	PAGE NO.
DOUBLE CONVOLUTED	
13.79" Dia. Bead Plate, 16.00" Molded Dia.	
28C	121
15.13" Dia. Bead Plate, 16.00" Molded Dia.	
201C	121
17.75" Dia. Bead Plate, 19.5" Molded Dia.	
203C	122
16.5" Dia. Bead Plate, 19.5" Molded Dia.	
203C	122
17.75" Dia. Bead Plate, 19.5" Molded Dia.	
218C	122
19.00" Dia. Bead Plate, 21.5" Molded Dia.	
29C	122
25.13" Dia. Bead Plate, 26.3" Molded Dia.	
215C	122
TRIPLE CONVOLUTED	
9.00" Dia. Bead Plate, 11.7" Molded Dia.	
38D	123 - 126
354D	126
10.38" Dia. Bead Plate, 11.7" Molded Dia.	
352C	126, 127
352D	126, 127
11.31" Dia. Bead Plate, 14.5" Molded Dia.	
313D	127, 128
39D	128
333C	129 - 132
13.79" Dia. Bead Plate, 16.00" Molded Dia.	
312C	132
15.13" Dia. Bead Plate, 16.00" Molded Dia.	
312C	132
16.5" Dia. Bead Plate, 19.5" Molded Dia.	
323C	132
19.00" Dia. Bead Plate, 21.5" Molded Dia.	
320C	133
25.13" Dia. Bead Plate, 26.3" Molded Dia.	
321C	133

Cross References

1T Piston Index by Piston Component Number

PISTON COMPONENT NO.	PISTON TYPE	MATERIAL	PISTON AON	PISTON DRAWING NO.	BELLOWS	PAGE NO.
3819	1T19G-9	Aluminum		NAD-19654	1T19F-3 or 1T19L-3	81
3822	1T15M-2	Aluminum		NBD-10378	1T15M-2	35
3853	1T15M-9	Aluminum		NBD-14153	1T15M-11	65
3882	1T17CA-5	Steel		NAD-31635	1T17CA-6	80
3894	1T19G-5	Aluminum	WC1-M58-1653	NAD-34318	1T19LC-5	83
8789	1T15S-6	Plastic	N/A	NBD-8881	1T15S-6 or 1T15AA-3	14
9505	1T15T-0	Plastic	WC1-358-1642	NBD-14537	1T15TM-1	66
9505	1T15T-0	Plastic	WC1-358-1642	NBD-14537	1T15TQ-1	69
9505	1T15T-0	Plastic	WC1-358-1642	NBD-14537	1T15T-2	69
9505	1T15T-0	Plastic	WC1-358-1642	NBD-14537	1T15T-1	66
9505	1T15T-0	Plastic	WC1-358-1642	NBD-14537	1T15TM-1	67
9508	1T14C-1	Plastic	WC1-358-0754	NBD-10441	1T14CB-1	8
9508	1T14C-1	Plastic	WC1-358-0754	NBD-10441	1T14C-3	11
9525	1T17B-6	Plastic	WC1-358-1609	NAD-26906	1T17CA-5	79
9525	1T17B-6	Plastic	WC1-358-1609	NAD-26906	1T17B-5	76
9527	1T15ZR-6	Plastic	WC1-358-1627	NAD-27265	1T15ZR-6	73
9528	1T15V-1	Plastic	WC1-358-0667	NBD-14404	1T17C-3	78
9528	1T15V-1	Plastic	WC1-358-0667	NBD-14404	1T15M-2	36
9528	1T15V-1	Plastic	WC1-358-0667	NBD-14404	1T15V-1	69
9528	1T15V-1	Plastic	WC1-358-0667	NBD-14404	1T15V-3	70
9530	1T15M-6	Plastic	WC1-358-9452	NAD-27809	1T15M-6	45-47
9530	1T15M-6	Plastic	WC1-358-9452	NAD-27809	1T15M-9	59-61
9530	1T15M-6	Plastic	WC1-358-9452	NAD-27809	1T15M-7.5	53
9530	1T15M-6	Plastic	WC1-358-9452	NAD-27809	1T15M-2	35
9530	1T15M-6	Plastic	WC1-358-9452	NAD-27809	1T15M-6	47, 49
9530	1T15M-6	Plastic	WC1-358-9452	NAD-27809	1T15M-6	49
9530	1T15M-6	Plastic	WC1-358-9452	NAD-27809	1T15M-7.5	54
9530	1T15M-6	Plastic	WC1-358-9452	NAD-27809	1T15V-8	72
9530	1T15M-6	Plastic	WC1-358-9452	NAD-27809	1T15L-9	28
9531	1T15MP-6	Plastic	WC1-358-1626	NAD-28197	1T15M-9	60
9532	1T15M-6	Plastic	WC1-358-1619	NAD-29827	1T17B-11	77
9532	1T15M-6	Plastic	WC1-358-1619	NAD-29827	1T15M-4	39
9532	1T15M-6	Plastic	WC1-358-1619	NAD-29827	1T15M-9	59, 60
9532	1T15M-6	Plastic	WC1-358-1619	NAD-29827	1T15MPW-7	53
9532	1T15M-6	Plastic	WC1-358-1619	NAD-29827	1T15M-6	46, 47
9532	1T15M-6	Plastic	WC1-358-1619	NAD-29827	1T15M-9	61
9532	1T15M-6	Plastic	WC1-358-1619	NAD-29827	1T15LP-5	27

Firestone

1T Piston Index by Piston Component Number

PISTON COMPONENT NO.	PISTON TYPE	MATERIAL	PISTON AON	PISTON DRAWING NO.	BELLOWS	PAGE NO.
9532	1T15M-6	Plastic	WC1-358-1619	NAD-29827	1T15M-2	37
9532	1T15M-6	Plastic	WC1-358-1619	NAD-29827	1T15M-6	50
9532	1T15M-6	Plastic	WC1-358-1619	NAD-29827	1T15V-8	71
9532	1T15M-6	Plastic	WC1-358-1619	NAD-29827	1T15M-6	50
9532	1T15M-6	Plastic	WC1-358-1619	NAD-29827	1T15L-9	28
9532	1T15M-6	Plastic	WC1-358-1619	NAD-29827	1T15LB-10	28
9532	1T15M-6	Plastic	WC1-358-1619	NAD-29827	1T15L-6	27
9532	1T15M-6	Plastic	WC1-358-1619	NAD-29827	1T15MBTW-6	51
9532	1T15M-6	Plastic	WC1-358-1619	NAD-29827	1T15MBTW-10	63
9532	1T15M-6	Plastic	WC1-358-1619	NAD-29827	1T15M-4	44
9532	1T15M-6	Plastic	WC1-358-1619	NAD-29827	1T15M-7.5	54-56
9533	1T17BB-2	Plastic	WC1-358-1644	NAD-30515	1T17CD-3	79
9533	1T17BB-2	Plastic	WC1-358-1644	NAD-30515	1T17BB-2	75
9534	1T15S-6	Plastic	N/A	NAD-29634	1T15S-6 or 1T15AA-3	13
9534	1T15S-6	Plastic	N/A	NAD-29634	1T15S-5 or 1T15AA-3	14
9534	1T15S-6	Plastic	N/A	NAD-29634	1T15AA-3	16
9535	1T15S-6	Aluminum	N/A	NAD-29592	1T15SN-3	65
9535	1T15S-6	Plastic	N/A	NAD-29592	1T15S-6 or 1T15AA-3	14
9535	1T15S-6	Plastic	N/A	NAD-29592	1T15SN-6	65
9535	1T15S-6	Plastic	N/A	NAD-29592	1T15AA-3	15
9535	1T15S-6	Plastic	N/A	NAD-29592	1T15S-6 or 1T15AA-3	16
9536	1T15S-6	Plastic	WC1-358-0755	NAD-29594	1T15AA-6	16
9536	1T15S-6	Plastic	WC1-358-0755	NAD-29594	1T15S-6 or 1T15AA-3	14
9536	1T15S-6	Plastic	WC1-358-0755	NAD-29594	1T15S-6 or 1T15AA-3	15
9536	1T15S-6	Plastic	WC1-358-0755	NAD-29594	1T15AA-3	15
9537	1T17B-7	Plastic	WC1-358-1637	NAD-29798	1T17CA-6.5	80
9538	1T15M-6	Plastic	WC1-358-1628	NAD-27740	1T15M-6	45
9538	1T15M-6	Plastic	WC1-358-1628	NAD-27740	1T15M-8	57
9538	1T15M-6	Plastic	WC1-358-1628	NAD-27740	1T15MT-6	52
9538	1T15M-6	Plastic	WC1-358-1628	NAD-27740	1T15M-8	57-59
9538	1T15M-6	Plastic	WC1-358-1628	NAD-27740	1T15MPW-7	53
9540	1T15M-9	Plastic	WC1-358-0664	NAD-29828	1T17B-11	77
9540	1T15M-9	Plastic	WC1-358-0664	NAD-29825	1T15LP-5	26
9540	1T15M-9	Plastic	WC1-358-0664	NAD-29828	1T15M-6	49

Cross References

1T Piston Index by Piston Component Number

PISTON COMPONENT NO.	PISTON TYPE	MATERIAL	PISTON AON	PISTON DRAWING NO.	BELLOWS	PAGE NO.
9540	1T15M-9	Plastic	WC1-358-0664	NAD-29828	1T15M-9	61
9540	1T15M-9	Plastic	WC1-358-0664	NAD-29848	1T15M-11	64
9540	1T15M-9	Plastic	WC1-358-0664	NAD-29828	1T15V-8	71
9540	1T15M-9	Plastic	WC1-358-0664	NAD-29828	1T15LC-12	28
9540	1T15M-9	Plastic	WC1-358-0664	NAD-29828	1T15MBTW-12	65
9540	1T15M-9	Plastic	WC1-358-0664	NAD-29828	1T15M-7.5	54, 55
9544	1T15M-4	Plastic	WC1-358-0666	NAD-29826	1T15M-4	40, 42
9544	1T15M-4	Plastic	WC1-358-0666	NAD-29826	1T15M-6	46
9544	1T15M-4	Plastic	WC1-358-0666	NAD-29826	1T15LP-5	27
9544	1T15M-4	Plastic	WC1-358-0666	NAD-29826	1T15M-2	38
9544	1T15M-4	Plastic	WC1-358-0666	NAD-29826	1T15V-8	71
9544	1T15M-4	Plastic	WC1-358-0666	NAD-29826	1T15M-4	44
9544	1T15M-4	Plastic	WC1-358-0666	NAD-29826	1T15M-7.5	54, 55
9544	1T15M-4	Plastic	WC1-358-0666	NAD-29826	1T15M-7.5	55
9544	1T15M-4	Plastic	WC1-358-0666	NAD-29826	1T15MPW-7	53
9549	1T15M-2	Plastic	WC1-358-1616	NAD-29454	1T15M-2	34
9549	1T15M-2	Plastic	WC1-358-1616	NAD-29454	1T15M-4	39
9549	1T15M-2	Plastic	WC1-358-1616	NAD-29454	1T15L-2	19
9549	1T15M-2	Plastic	WC1-358-1616	NAD-29454	1T15L-4	24, 25
9549	1T15M-2	Plastic	WC1-358-1616	NAD-29454	1T15LP-5	26
9549	1T15M-2	Plastic	WC1-358-1616	NAD-29454	1T15LP-2	23
9549	1T15M-2	Plastic	WC1-358-1616	NAD-29454	1T15M-4	43, 44
9549	1T15M-2	Plastic	WC1-358-1616	NAD-29454	1T15M-2	33-38
9550	1T15M-2	Plastic	WC1-358-1652	NAD-29456	1T15MT-3	39
9550	1T15M-2	Plastic	WC1-358-1652	NAD-29456	1T15MT-3	39
9553	1T15M-9	Plastic	WC1-358-9453	NAD-29467	1T15M-6	47
9553	1T15M-9	Plastic	WC1-358-9453	NAD-29467	1T15M-9	60, 61
9553	1T15M-9	Plastic	WC1-358-9453	NAD-29467	1T15M-11	63, 64
9553	1T15M-9	Plastic	WC1-358-9453	NAD-29467	1T15M-9	62
9553	1T15M-9	Plastic	WC1-358-9453	NAD-29467	1T15M-11	64
9553	1T15M-9	Plastic	WC1-358-9453	NAD-29467	1T15M-6	50
9553	1T15M-9	Plastic	WC1-358-9453	NAD-29467	1T15M-9	62
9553	1T15M-9	Plastic	WC1-358-9453	NAD-29467	1T15V-8	72
9553	1T15M-9	Plastic	WC1-358-9453	NAD-29467	1T15M-11	64

Firestone

1T Piston Index by Piston Component Number

PISTON COMPONENT NO.	PISTON TYPE	MATERIAL	PISTON AON	PISTON DRAWING NO.	BELLOWS	PAGE NO.
9555	1T14C-1	Plastic	WC1-358-0609	NBD-10500	1T14C-1	7
9555	1T14C-1	Plastic	WC1-358-0609	NBD-10500	1T14CB-1	8, 9
9557	1T15MP-6	Plastic	WC1-358-1654	NAD-31181	1T15VMW-8	72
9557	1T15MP-6	Plastic	WC1-358-6262	NAD-31181	1T15MPW-7	53
9560	1T15M-6	Plastic	WC1-358-1620	NAD-32768	1T15M-6	48
9560	1T15M-6	Plastic	WC1-358-1620	NAD-32768	1T15M-6	49
9560	1T15M-6	Plastic	WC1-358-1620	NAD-32768	1T15M-8	56, 57
9561	1T15M-6	Plastic	WC1-358-1606	NAD-32767	1T15MT-6	52
9561	1T15M-6	Plastic	WC1-358-1606	NAD-32767	1T15M-8	58
9562	1T19L-9	Plastic	WC1-358-1651	NAD-33610	1T19L-11	90
9563	1T15M-6	Plastic	N/A	NAD-34178	1T15M-7.5	56
9569	1T15KW-0	Plastic	WC1-358-1629	NAD-27754	1T15M-0.5	32
9569	1T15KW-0	Plastic	WC1-358-1629	NAD-27754	1T15LA-0 1T15KW-0	17
9569	1T15KW-0	Plastic	WC1-358-1629	NAD-27754	1T15LA-(-1) 1T15KW-(-1)	17
9569	1T15KW-0	Plastic	WC1-358-1629	NAD-27754	1T15LP-2	23
9569	1T15KW-0	Plastic	WC1-358-1629	NAD-27754	1T15LA-0 1T15KW-0	18
9570	1T15KW-1.5	Plastic	WC1-358-0647	NAD-18162	1T15M-0	32
9570	1T15KW-1.5	Plastic	WC1-358-0647	NAD-18162	1T15L-1.5	19
9571	1T15KW-1.5	Plastic	WC1-358-0646	NAD-18130	1T15M-2	36
9571	1T15KW-1.5	Plastic	WC1-358-0646	NAD-18130	1T15M-0	29, 30
9571	1T15KW-1.5	Plastic	WC1-358-0646	NAD-18130	1T15L-2	20
9571	1T15KW-1.5	Plastic	WC1-358-0646	NAD-18130	1T15L-1.5 1T15KW-1.5	18, 19
9571	1T15KW-1.5	Plastic	WC1-358-0646	NAD-18130	1T15T-1	66
9572	1T15KW-1.5	Plastic	N/A	NAD-18161	1T15-L-1.5	18
9572	1T15KW-1.5	Plastic	N/A	NAD-18161	1T15M-0	28
9572	1T15KW-1.5	Plastic	N/A	NAD-18161	1T15L-2	22
9572	1T15KW-1.5	Plastic	N/A	NAD-18161	1T15LP-2	23
9573	1T15KW-1.5	Plastic	WC1-358-1634	NAD-18162	1T15M-2	33, 34
9573	1T15KW-1.5	Plastic	WC1-358-1634	NAD-18162	1T15M-4	40
9573	1T15KW-1.5	Plastic	WC1-358-1634	NAD-18162	1T15M-4	41
9573	1T15KW-1.5	Plastic	WC1-358-1634	NAD-18162	1T15M-0	29
9573	1T15KW-1.5	Plastic	WC1-358-1634	NAD-18162	1T15L-3	24
9573	1T15KW-1.5	Plastic	WC1-358-1634	NAD-18162	1T15LP-5	27
9573	1T15KW-1.5	Plastic	WC1-358-1634	NAD-18162	1T15M-0.5	33
9573	1T15KW-1.5	Plastic	WC1-358-1634	NAD-18162	1T15M-4	43
9573	1T15KW-1.5	Plastic	WC1-358-1634	NAD-18162	1T15M-2	38

Cross References

1T Piston Index by Piston Component Number

PISTON COMPONENT NO.	PISTON TYPE	MATERIAL	PISTON AON	PISTON DRAWING NO.	BELLOWS	PAGE NO.
9573	1T15KW-1.5	Plastic	WC1-358-1634	NAD-18162	1T15L-2	20
9573	1T15KW-1.5	Plastic	WC1-358-1634	NAD-18162	1T15M-2	35
9575	1T66E-11	Plastic	N/A	NAD-26944	1T66E-11.8	94
9579	1T19F-9	Plastic	WC1-358-1679	NAD-19969	1T19N-9 or 1T19L-9	93
9580	1T19F-11	Plastic	WC1-358-0528	NAD-27909	1T19F-12 or 1T19L-12	90, 91
9580	1T19F-11	Plastic	WC1-358-0528	NAD-27909	1T19LC-11	90
9580	1T19F-11	Plastic	WC1-358-0528	NAD-27909	1T19F-9 or 1T19L-9	87
9580	1T19F-11	Plastic	WC1-358-0528	NAD-27909	1T19F-11 or 1T19L-11	88, 89
9580	1T19F-11	Plastic	WC1-358-0528	NAD-27909	1T19F-7 or 1T19I-7	86
9594	1T19LC-5	Plastic	WC1-358-1614	NAD-28384	1T19FC-6 or 1T19LC-6	83
9594	1T19LC-5	Plastic	WC1-358-1614	NAD-28384	1T19FC-8 or 1T19LC-8	87
9594	1T19LC-5	Plastic	WC1-358-1614	NAD-28384	1T19LF-7	84
9596	1T15S-6	Plastic	N/A	NAD-31791	1T15AA-3	16
9602	1T15V-5	Aluminum	WC1-358-1613	NAD-28351	1T17B-5	75, 76
9602	1T15V-5	Aluminum	WC1-358-1613	NAD-28351	1T15VP-4	70
9603	1T15V-5	Plastic	WC1-358-1635	NAD-29630	1T17C-3	78
9603	1T15V-5	Aluminum	WC1-358-1635	NAD-29630	1T17B-5	75
9603	1T15V-5	Aluminum	WC1-358-1635	NAD-29630	1T17C-3	78
9603	1T15V-5	Aluminum	WC1-358-1635	NAD-29630	1T17C-6.5	79
9603	1T15V-5	Aluminum	WC1-358-1635	NAD-29630	1T17B-5	77
9604	1T15ZR-6	Aluminum	WC1-358-1624	NAD-30174	1T15ZR-6	73
9642	1T19F-9	Aluminum	N/A	NAD-33001	1T19F-11 or 1T19L-11	89
9644	1T19ZR-6.2	Steel	N/A	NAD-31862	1T19ZK-5.7	93, 94
9645	1T15CCR-6	Steel	N/A	NAD-31622	1T15AA-6	17
9646	1T17B17	Steel	N/A	NAD-31215	1T17BP-17	78
9648	1T17B-4	Steel	WC1-358-1649	NAD-31288	1T17CA-3	79
9651	1T14C-3	Aluminum	WC1-358-9095	NBD-11498	1T14C-1	7
9651	1T14C-3	Aluminum	WC1-358-9095	NBD-11498	1T14C-3	10
9651	1T14C-3	Aluminum	WC1-358-9095	NBD-11498	1T14C-5	12
9651	1T14C-3	Aluminum	WC1-358-9095	NBD-11498	1T14CB-1	8
9653	1T15M-9	Aluminum	WC1-358-9453	NBD-10437	1T15M-11	63, 64
9654	1T15M-0	Aluminum	WC1-358-0663	NBD-10438	1T15L-2	19

Firestone

1T Piston Index by Piston Component Number

PISTON COMPONENT NO.	PISTON TYPE	MATERIAL	PISTON AON	PISTON DRAWING NO.	BELLOWS	PAGE NO.
9654	1T15M-0	Aluminum	WC1-358-0663	NBD-10438	1T15M-0	30-32
9654	1T15M-0	Aluminum	WC1-358-0663	NBD-10438	1T15L-2	22
9654	1T15M-0	Aluminum	WC1-358-0663	NBD-10438	1T15T-1	66
9655	1T15M-0	Aluminum	WC1-358-9454	NBD-10439	1T15M-0	29
9655	1T15M-0	Aluminum	WC1-358-9454	NBD-10439	1T15M-0	30
9655	1T15M-0	Aluminum	WC1-358-9454	NBD-10439	1T15M-0	31
9655	1T15M-0	Aluminum	WC1-358-9454	NBD-10439	1T15TM-1	67
9655	1T15M-0	Aluminum	WC1-358-9454	NBD-10439	1T15L-2	21
9656	1T15M-2	Aluminum	WC1-358-0652	NBD-10267	1T15M-4	40
9656	1T15M-2	Aluminum	WC1-358-0652	NBD-10267	1T15LP-2	22
9656	1T15M-2	Aluminum	WC1-358-0652	NBD-10267	1T15M-2	36, 37
9656	1T15M-2	Aluminum	WC1-358-0652	NBD-10267	1T15M-4	42
9656	1T15M-2	Aluminum	WC1-358-0652	NBD-10267	1T15L-4	25
9656	1T15M-2	Aluminum	WC1-358-0652	NBD-10267	1T15M-4	43, 45
9657	1T19E-1	Aluminum	WC1-358-9450	NAD-18101	1T19F-5 or 1T19L-5	81
9657	1T19E-1	Aluminum	WC1-358-9450	NAD-18101	1T19F-7 or 1T19L-7	84-86
9657	1T19E-1	Aluminum	WC1-358-9450	NAD-18101	1T19F-9 or 1T19L-9	87, 88
9657	1T19E-1	Aluminum	WC1-358-9450	NAD-18101	1T19F-7	86
9657	1T19E-1	Aluminum	WC1-358-9450	NAD-18101	1T19F-5 or 1T19L-5	82, 83
9657	1T19E-1	Aluminum	WC1-358-9450	NAD-18101	1T19F-7 or 1T19L-7	86
9658	1T19E-2	Aluminum	WC1-358-1640	NAD-18102	1T19F-11 or 1T19L-11	88
9659	1T15T-3	Aluminum	WC1-358-0683	NBD-10472	1T15LP-1.5	19
9659	1T15T-3	Aluminum	WC1-358-0683	NBD-10472	1T15L-4	24, 25
9659	1T15T-3	Aluminum	WC1-358-0683	NBD-10472	1T15L-2	21, 22
9659	1T15T-3	Aluminum	WC1-358-0683	NBD-10472	1T15L-2	21
9663	1T15L-2	Aluminum	N/A	NBD-12639	1T15LC-2.5	23, 24
9663	1T15L-2	Aluminum	N/A	NBD-12639	1T15LC-4.5	26
9666	1T19G-9	Aluminum	N/A	NAD-19631	1T19LE-12	91
9666	1T19G-9	Aluminum	N/A	NAD-19631	1T19LE-8	87
9669	1T19F-12	Aluminum	WC1-358-1602	NAD-26291	1T19F-12 or 1T19L-12	90-91
9669	1T19F-12	Aluminum	WC1-358-1602	NAD-26291	1T19F-14 or 1T19L-14	91, 92
9669	1T19F-12	Aluminum	WC1-358-1602	NAD-26291	1T19F-16 or 1T19L-16	92

Cross References

1T Piston Index by Piston Component Number

PISTON COMPONENT NO.	PISTON TYPE	MATERIAL	PISTON AON	PISTON DRAWING NO.	BELLOWS	PAGE NO.
9671	1T17AZF	Steel	N/A	NAD-32590	1T17AEZR-5	75
9671	1T17AZF	Steel	N/A	NAD-32590	1T17AZR-4.5	75
9676	1T15ZR-6	Steel	N/A	NAD-31612	1T15ZR-6	74
9677	1T19E-2	Steel	N/A	NAD-32770	1T19F-11 or 1T19L-11	90
9681	1T15Y-1	Aluminum	WC1-358-1612	NBD-14213	1T15TQ-1	67-69
9689	1T15V-11	Aluminum	WC1-358-1607	NAD-28838	1T17CL-9.5	80, 81
9690	1T15V-11	Aluminum	N/A	NAD-28840	1T17C-8	80
9691	1T15L-4	Aluminum	WC1-358-0606	NBD-14503	1T15L-4	25, 26
9694	1T15MM-9	Aluminum	WC1-358-1694	NAD-25396	1T15MLW-7	52
9694	1T15MM-9	Aluminum	WC1-358-1694	NAD-25396	1T15LP-6	27
9694	1T15MM-9	Aluminum	WC1-358-1694	NAD-25396	1T15MM-9	63
9694	1T15MM-9	Aluminum	WC1-358-1694	NAD-25396	1T15MW-6	52
9696	1T15M-7.5	Aluminum	WC1-358-1636	NBD-14366	1T15M-7.5	56
9702	1T15M-2	Aluminum	WC1-358-1608	NAD-27357	1T15MT-3	39
9708	1T14C-1	Aluminum	WC1-358-0600	NBD-8626	1T14C-1	7
9708	1T14C-1	Aluminum	WC1-358-0600	NBD-8626	1T14C-1 or 1T14F-2	7, 8
9708	1T14C-1	Aluminum	WC1-358-0600	NBD-8626	1T14C-3 or 1T14F-4	9
9708	1T14C-1	Aluminum	WC1-358-0600	NBD-8626	1T14C-3	9-11
9708	1T14C-1	Aluminum	WC1-358-0600	NBD-8626	1T14C-7 or 1T14F-8	13
9727	1T15M-4	Aluminum	WC1-358-0651	NBD-8725	1T15M-4	40-42
9727	1T15M-4	Aluminum	WC1-358-0651	NBD-8725	1T15M-2	35
9727	1T15M-4	Aluminum	WC1-358-0651	NBD-8725	1T15M-6	46, 50
9727	1T15M-4	Aluminum	WC1-358-0651	NBD-8725	1T15V-8	72
9727	1T15M-4	Aluminum	WC1-358-0651	NBD-8724	1T15M-4	44
9728	1T15V-7	Aluminum	WC1-358-0669	NBD-8987	1T15M-6	49
9728	1T15V-7	Aluminum	WC1-358-0669	NBD-8987	1T15V-8	70
9728	1T15V-7	Aluminum	WC1-358-0669	NBD-8987	1T15M-4	43
9734	1T15M-6	Aluminum	WC1-358-1610	NAD-28002	1T17B-5	76
9742	1T15M-2	Aluminum	WC1-358-0658	NBD-8055	1T15M-2	36
9743	1T15M-2	Aluminum	WC1-358-0653	NBD-8183	1T15L-2	20
9743	1T15M-2	Aluminum	WC1-358-0653	NBD-8183	1T15L-4	25
9744	1T15MJ-6	Aluminum	N/A	NBD-9673	1T15MJ-6	51, 52
9745	1T15T-0	Aluminum	WC1-358-0682	NBD-8312	1T15T-1	65
9754	1T14C-7	Aluminum	WC1-358-1603	NBD-11689	1T14C-8	13
9754	1T14C-7	Aluminum	WC1-358-1603	NBD-11689	1T14C-6	12

Firestone

1T Piston Index by Piston Component Number

PISTON COMPONENT NO.	PISTON TYPE	MATERIAL	PISTON AON	PISTON DRAWING NO.	BELLOWS	PAGE NO.
9754	1T14C-7	Aluminum	WC1-358-1603	NBD-11689	1T14C-7	13
9754	1T14C-7	Aluminum	WC1-358-1603	NBD-11689	1T14C-6	12
9757	1T15B-2	Aluminum	N/A	NBD-9242	1T15S-6 or 1T15AA-3	14
9757	1T15B-2	Aluminum	N/A	NBD-9242	1T15AA-3	15
9760	1T19F-11	Steel	WC1-358-0675	NAD-11668	1T19F-7 or 1T30E-1	85
9765	1T19J-6	Aluminum	WC1-358-0684	NAD-29060	1T19J-6	93
9766	1T19G-5	Aluminum	WC1-358-0631	NAD-28978	1T19FC-5 or 1T19LC-5	83
9766	1T19G-5	Aluminum	WC1-358-0631	NAD-28978	1T19L-5	82
9766	1T19G-5	Aluminum	WC1-358-0631	NAD-28978	1T19F-3 or 1T19L-3	81
9766	1T19G-5	Aluminum	WC1-358-0631	NAD-28978	1T19F-5 or 1T19L-5	82, 83
9766	1T19G-5	Aluminum	WC1-358-0631	NAD-28978	1T19F-7 or 1T19L-7	86
9769	1T19J-2	Aluminum	WC1-358-0685	NBD-10180	1T19J-1	93
9778	1T14F-4	Aluminum	WC1-358-0686	NAD-18053	1T14C-5	11, 12
9778	1T14F-4	Aluminum	WC1-358-0686	NAD-18053	1T14C-3 or 1T14F-4	10
9778	1T14F-4	Aluminum	WC1-358-0686	NAD-18053	1T14C-7	13
9778	1T14F-4	Aluminum	WC1-358-0686	NAD-18053	1T14C-3	11
9802	1T17B-7	Aluminum	WC1-358-1611	NAD-27999	1T17CL-5	79
9802	1T17B-7	Aluminum	WC1-358-1611	NAD-27999	1T17B-5	76
9803	1T15V-11	Aluminum	WC1-358-0680	NAD-15324	1T15V-11	73
9806	1T15L-6HG	Aluminum	WC1-358-0660	NBD-9611	1T15M-6	51
9809	1T15L-6HG	Aluminum	WC1-358-0660	NBD-9611	1T15M-6	48, 51
9951	1T15M-6	Aluminum	WC1-358-0697	NAD-17833	1T15M-6	48, 50

Cross References

1T Piston Index by Piston Drawing Number

PISTON DRAWING NO.	PISTON COMPONENT NO.	PISTON TYPE	MATERIAL	PISTON AON	BELLOWS	PAGE NO.
NAD-11668	9760	1T19F-11	Steel	WC1-358-0675	1T19F-7 or 1T30E-1	85
NAD-15324	9803	1T15V-11	Aluminum	WC1-358-0680	1T15V-11	73
NAD-17833	9951	1T15M-6	Aluminum	WC1-358-0697	1T15M-6	48, 50
NAD-18053	9778	1T14F-4	Aluminum	WC1-358-0686	1T14C-5	11, 12
NAD-18053	9778	1T14F-4	Aluminum	WC1-358-0686	1T14C-3 or 1T14F-4	10
NAD-18053	9778	1T14F-4	Aluminum	WC1-358-0686	1T14C-7	13
NAD-18053	9778	1T14F-4	Aluminum	WC1-358-0686	1T14C-3	11
NAD-18101	9657	1T19E-1	Aluminum	WC1-358-9450	1T19F-5 or 1T19L-5	81
NAD-18101	9657	1T19E-1	Aluminum	WC1-358-9450	1T19F-7 or 1T19L-7	84-86
NAD-18101	9657	1T19E-1	Aluminum	WC1-358-9450	1T19F-9 or 1T19L-9	87, 88
NAD-18101	9657	1T19E-1	Aluminum	WC1-358-9450	1T19F-7	86
NAD-18101	9657	1T19E-1	Aluminum	WC1-358-9450	1T19F-5 or 1T19L-5	82, 83
NAD-18101	9657	1T19E-1	Aluminum	WC1-358-9450	1T19F-7 or 1T19L-7	86
NAD-18102	9658	1T19E-2	Aluminum	WC1-358-1640	1T19F-11 or 1T19L-11	88
NAD-18130	9571	1T15KW-1.5	Plastic	WC1-358-0646	1T15M-2	36
NAD-18130	9571	1T15KW-1.5	Plastic	WC1-358-0646	1T15M-0	29, 30
NAD-18130	9571	1T15KW-1.5	Plastic	WC1-358-0646	1T15L-2	20
NAD-18130	9571	1T15KW-1.5	Plastic	WC1-358-0646	1T15L-1.5 1T15KW-1.5	18, 19
NAD-18130	9571	1T15KW-1.5	Plastic	WC1-358-0646	1T15T-1	66
NAD-18161	9572	1T15KW-1.5	Plastic	N/A	1T15-L-1.5	18
NAD-18161	9572	1T15KW-1.5	Plastic	N/A	1T15M-0	28
NAD-18161	9572	1T15KW-1.5	Plastic	N/A	1T15L-2	22
NAD-18161	9572	1T15KW-1.5	Plastic	N/A	1T15LP-2	23
NAD-18162	9570	1T15KW-1.5	Plastic	WC1-358-0647	1T15M-0	32
NAD-18162	9570	1T15KW-1.5	Plastic	WC1-358-0647	1T15L-1.5	19
NAD-18162	9573	1T15KW-1.5	Plastic	WC1-358-1634	1T15M-2	33, 34
NAD-18162	9573	1T15KW-1.5	Plastic	WC1-358-1634	1T15M-4	40
NAD-18162	9573	1T15KW-1.5	Plastic	WC1-358-1634	1T15M-4	41
NAD-18162	9573	1T15KW-1.5	Plastic	WC1-358-1634	1T15M-0	29
NAD-18162	9573	1T15KW-1.5	Plastic	WC1-358-1634	1T15L-3	24
NAD-18162	9573	1T15KW-1.5	Plastic	WC1-358-1634	1T15LP-5	27

Firestone

1T Piston Index by Piston Drawing Number

PISTON DRAWING NO.	PISTON COMPONENT NO.	PISTON TYPE	MATERIAL	PISTON AON	BELLOWS	PAGE NO.
NAD-18162	9573	1T15KW-1.5	Plastic	WC1-358-1634	1T15M-0.5	33
NAD-18162	9573	1T15KW-1.5	Plastic	WC1-358-1634	1T15M-4	43
NAD-18162	9573	1T15KW-1.5	Plastic	WC1-358-1634	1T15M-2	38
NAD-18162	9573	1T15KW-1.5	Plastic	WC1-358-1634	1T15L-2	20
NAD-18162	9573	1T15KW-1.5	Plastic	WC1-358-1634	1T15M-2	35
NAD-19631	9666	1T19G-9	Aluminum	N/A	1T19LE-12	91
NAD-19631	9666	1T19G-9	Aluminum	N/A	1T19LE-8	87
NAD-19654	3819	1T19G-9	Aluminum		1T19F-3 or 1T19L-3	81
NAD-19969	9579	1T19F-9	Plastic	WC1-358-1679	1T19N-9 or 1T19L-9	93
NAD-25396	9694	1T15MM-9	Aluminum	WC1-358-1694	1T15MLW-7	52
NAD-25396	9694	1T15MM-9	Aluminum	WC1-358-1694	1T15LP-6	27
NAD-25396	9694	1T15MM-9	Aluminum	WC1-358-1694	1T15MM-9	63
NAD-25396	9694	1T15MM-9	Aluminum	WC1-358-1694	1T15MW-6	52
NAD-26291	9669	1T19F-12	Aluminum	WC1-358-1602	1T19F-12 or 1T19L-12	90-91
NAD-26291	9669	1T19F-12	Aluminum	WC1-358-1602	1T19F-14 or 1T19L-14	91, 92
NAD-26291	9669	1T19F-12	Aluminum	WC1-358-1602	1T19F-16 or 1T19L-16	92
NAD-26906	9525	1T17B-6	Plastic	WC1-358-1609	1T17CA-5	79
NAD-26906	9525	1T17B-6	Plastic	WC1-358-1609	1T17B-5	76
NAD-26944	9575	1T66E-11	Plastic	N/A	1T66E-11.8	94
NAD-27265	9527	1T15ZR-6	Plastic	WC1-358-1627	1T15ZR-6	73
NAD-27357	9702	1T15M-2	Aluminum	WC1-358-1608	1T15MT-3	39
NAD-27740	9538	1T15M-6	Plastic	WC1-358-1628	1T15M-6	45
NAD-27740	9538	1T15M-6	Plastic	WC1-358-1628	1T15M-8	57
NAD-27740	9538	1T15M-6	Plastic	WC1-358-1628	1T15MT-6	52
NAD-27740	9538	1T15M-6	Plastic	WC1-358-1628	1T15M-8	57-59
NAD-27740	9538	1T15M-6	Plastic	WC1-358-1628	1T15MPW-7	53
NAD-27754	9569	1T15KW-0	Plastic	WC1-358-1629	1T15M-0.5	32
NAD-27754	9569	1T15KW-0	Plastic	WC1-358-1629	1T15LA-0 1T15KW-0	17
NAD-27754	9569	1T15KW-0	Plastic	WC1-358-1629	1T15LA-(-1) 1T15KW-(-1)	17
NAD-27754	9569	1T15KW-0	Plastic	WC1-358-1629	1T15LP-2	23
NAD-27754	9569	1T15KW-0	Plastic	WC1-358-1629	1T15LA-0 1T15KW-0	18

Cross References

1T Piston Index by Piston Drawing Number

PISTON DRAWING NO.	PISTON COMPONENT NO.	PISTON TYPE	MATERIAL	PISTON AON	BELLOWS	PAGE NO.
NAD-27809	9530	1T15M-6	Plastic	WC1-358-9452	1T15M-6	45-47
NAD-27809	9530	1T15M-6	Plastic	WC1-358-9452	1T15M-9	59-61
NAD-27809	9530	1T15M-6	Plastic	WC1-358-9452	1T15M-7.5	53
NAD-27809	9530	1T15M-6	Plastic	WC1-358-9452	1T15M-2	35
NAD-27809	9530	1T15M-6	Plastic	WC1-358-9452	1T15M-6	47, 49
NAD-27809	9530	1T15M-6	Plastic	WC1-358-9452	1T15M-6	49
NAD-27809	9530	1T15M-6	Plastic	WC1-358-9452	1T15M-7.5	54
NAD-27809	9530	1T15M-6	Plastic	WC1-358-9452	1T15V-8	72
NAD-27809	9530	1T15M-6	Plastic	WC1-358-9452	1T15L-9	28
NAD-27909	9580	1T19F-11	Plastic	WC1-358-0528	1T19F-12 or 1T19L-12	90, 91
NAD-27909	9580	1T19F-11	Plastic	WC1-358-0528	1T19LC-11	90
NAD-27909	9580	1T19F-11	Plastic	WC1-358-0528	1T19F-9 or 1T19L-9	87
NAD-27909	9580	1T19F-11	Plastic	WC1-358-0528	1T19F-11 or 1T19L-11	88, 89
NAD-27909	9580	1T19F-11	Plastic	WC1-358-0528	1T19F-7 or 1T19L-7	86
NAD-27999	9802	1T17B-7	Aluminum	WC1-358-1611	1T17CL-5	79
NAD-27999	9802	1T17B-7	Aluminum	WC1-358-1611	1T17B-5	76
NAD-28002	9734	1T15M-6	Aluminum	WC1-358-1610	1T17B-5	76
NAD-28197	9531	1T15MP-6	Plastic	WC1-358-1626	1T15M-9	60
NAD-28351	9602	1T15V-5	Aluminum	WC1-358-1613	1T17B-5	75, 76
NAD-28351	9602	1T15V-5	Aluminum	WC1-358-1613	1T15VP-4	70
NAD-28384	9594	1T19LC-5	Plastic	WC1-358-1614	1T19FC-6 or 1T19LC-6	83
NAD-28384	9594	1T19LC-5	Plastic	WC1-358-1614	1T19FC-8 or 1T19LC-8	87
NAD-28384	9594	1T19LC-5	Plastic	WC1-358-1614	1T19LF-7	84
NAD-28838	9689	1T15V-11	Aluminum	WC1-358-1607	1T17CL-9.5	80, 81
NAD-28840	9690	1T15V-11	Aluminum	N/A	1T17C-8	80
NAD-28978	9766	1T19G-5	Aluminum	WC1-358-0631	1T19FC-5 or 1T19LC-5	83
NAD-28978	9766	1T19G-5	Aluminum	WC1-358-0631	1T19L-5	82
NAD-28978	9766	1T19G-5	Aluminum	WC1-358-0631	1T19F-3 or 1T19L-3	81
NAD-28978	9766	1T19G-5	Aluminum	WC1-358-0631	1T19F-5 or 1T19L-5	82, 83
NAD-28978	9766	1T19G-5	Aluminum	WC1-358-0631	1T19F-7 or 1T19L-7	86
NAD-29060	9765	1T19J-6	Aluminum	WC1-358-0684	1T19J-6	93

Firestone

1T Piston Index by Piston Drawing Number

PISTON DRAWING NO.	PISTON COMPONENT NO.	PISTON TYPE	MATERIAL	PISTON AON	BELLOWS	PAGE NO.
NAD-29454	9549	1T15M-2	Plastic	WC1-358-1616	1T15M-2	34
NAD-29454	9549	1T15M-2	Plastic	WC1-358-1616	1T15M-4	39
NAD-29454	9549	1T15M-2	Plastic	WC1-358-1616	1T15L-2	19
NAD-29454	9549	1T15M-2	Plastic	WC1-358-1616	1T15L-4	24, 25
NAD-29454	9549	1T15M-2	Plastic	WC1-358-1616	1T15LP-5	26
NAD-29454	9549	1T15M-2	Plastic	WC1-358-1616	1T15LP-2	23
NAD-29454	9549	1T15M-2	Plastic	WC1-358-1616	1T15M-4	43, 44
NAD-29454	9549	1T15M-2	Plastic	WC1-358-1616	1T15M-2	33-38
NAD-29456	9550	1T15M-2	Plastic	WC1-358-1652	1T15MT-3	39
NAD-29456	9550	1T15M-2	Plastic	WC1-358-1652	1T15MT-3	39
NAD-29467	9553	1T15M-9	Plastic	WC1-358-9453	1T15M-6	47
NAD-29467	9553	1T15M-9	Plastic	WC1-358-9453	1T15M-9	60, 61
NAD-29467	9553	1T15M-9	Plastic	WC1-358-9453	1T15M-11	63, 64
NAD-29467	9553	1T15M-9	Plastic	WC1-358-9453	1T15M-9	62
NAD-29467	9553	1T15M-9	Plastic	WC1-358-9453	1T15M-11	64
NAD-29467	9553	1T15M-9	Plastic	WC1-358-9453	1T15M-6	50
NAD-29467	9553	1T15M-9	Plastic	WC1-358-9453	1T15M-9	62
NAD-29467	9553	1T15M-9	Plastic	WC1-358-9453	1T15V-8	72
NAD-29467	9553	1T15M-9	Plastic	WC1-358-9453	1T15M-11	64
NAD-29592	9535	1T15S-6	Aluminum	N/A	1T15SN-3	65
NAD-29592	9535	1T15S-6	Plastic	N/A	1T15S-6 or 1T15AA-3	14
NAD-29592	9535	1T15S-6	Plastic	N/A	1T15SN-6	65
NAD-29592	9535	1T15S-6	Plastic	N/A	1T15AA-3	15
NAD-29592	9535	1T15S-6	Plastic	N/A	1T15S-6 or 1T15AA-3	16
NAD-29594	9536	1T15S-6	Plastic	WC1-358-0755	1T15AA-6	16
NAD-29594	9536	1T15S-6	Plastic	WC1-358-0755	1T15S-6 or 1T15AA-3	14
NAD-29594	9536	1T15S-6	Plastic	WC1-358-0755	1T15S-6 or 1T15AA-3	15
NAD-29594	9536	1T15S-6	Plastic	WC1-358-0755	1T15AA-3	15
NAD-29630	9603	1T15V-5	Plastic	WC1-358-1635	1T17C-3	78
NAD-29630	9603	1T15V-5	Aluminum	WC1-358-1635	1T17B-5	75
NAD-29630	9603	1T15V-5	Aluminum	WC1-358-1635	1T17C-3	78
NAD-29630	9603	1T15V-5	Aluminum	WC1-358-1635	1T17C-6.5	79
NAD-29630	9603	1T15V-5	Aluminum	WC1-358-1635	1T17B-5	77
NAD-29634	9534	1T15S-6	Plastic	N/A	1T15S-6 or 1T15AA-3	13

Cross References

1T Piston Index by Piston Drawing Number

PISTON DRAWING NO.	PISTON COMPONENT NO.	PISTON TYPE	MATERIAL	PISTON AON	BELLOWS	PAGE NO.
NAD-29634	9534	1T15S-6	Plastic	N/A	1T15S-5 or 1T15AA-3	14
NAD-29634	9534	1T15S-6	Plastic	N/A	1T15AA-3	16
NAD-29798	9537	1T17B-7	Plastic	WC1-358-1637	1T17CA-6.5	80
NAD-29825	9540	1T15M-9	Plastic	WC1-358-0664	1T15LP-5	26
NAD-29826	9544	1T15M-4	Plastic	WC1-358-0666	1T15M-4	40, 42
NAD-29826	9544	1T15M-4	Plastic	WC1-358-0666	1T15M-6	46
NAD-29826	9544	1T15M-4	Plastic	WC1-358-0666	1T15LP-5	27
NAD-29826	9544	1T15M-4	Plastic	WC1-358-0666	1T15M-2	38
NAD-29826	9544	1T15M-4	Plastic	WC1-358-0666	1T15V-8	71
NAD-29826	9544	1T15M-4	Plastic	WC1-358-0666	1T15M-4	44
NAD-29826	9544	1T15M-4	Plastic	WC1-358-0666	1T15M-7.5	54, 55
NAD-29826	9544	1T15M-4	Plastic	WC1-358-0666	1T15M-7.5	55
NAD-29826	9544	1T15M-4	Plastic	WC1-358-0666	1T15MPW-7	53
NAD-29827	9532	1T15M-6	Plastic	WC1-358-1619	1T17B-11	77
NAD-29827	9532	1T15M-6	Plastic	WC1-358-1619	1T15M-4	39
NAD-29827	9532	1T15M-6	Plastic	WC1-358-1619	1T15M-9	59, 60
NAD-29827	9532	1T15M-6	Plastic	WC1-358-1619	1T15MPW-7	53
NAD-29827	9532	1T15M-6	Plastic	WC1-358-1619	1T15M-6	46, 47
NAD-29827	9532	1T15M-6	Plastic	WC1-358-1619	1T15M-9	61
NAD-29827	9532	1T15M-6	Plastic	WC1-358-1619	1T15LP-5	27
NAD-29827	9532	1T15M-6	Plastic	WC1-358-1619	1T15M-2	37
NAD-29827	9532	1T15M-6	Plastic	WC1-358-1619	1T15M-6	50
NAD-29827	9532	1T15M-6	Plastic	WC1-358-1619	1T15V-8	71
NAD-29827	9532	1T15M-6	Plastic	WC1-358-1619	1T15M-6	50
NAD-29827	9532	1T15M-6	Plastic	WC1-358-1619	1T15L-9	28
NAD-29827	9532	1T15M-6	Plastic	WC1-358-1619	1T15LB-10	28
NAD-29827	9532	1T15M-6	Plastic	WC1-358-1619	1T15L-6	27
NAD-29827	9532	1T15M-6	Plastic	WC1-358-1619	1T15MB-TW-6	51
NAD-29827	9532	1T15M-6	Plastic	WC1-358-1619	1T15MB-TW-10	63
NAD-29827	9532	1T15M-6	Plastic	WC1-358-1619	1T15M-4	44
NAD-29827	9532	1T15M-6	Plastic	WC1-358-1619	1T15M-7.5	54-56
NAD-29828	9540	1T15M-9	Plastic	WC1-358-0664	1T17B-11	77
NAD-29828	9540	1T15M-9	Plastic	WC1-358-0664	1T15M-6	49
NAD-29828	9540	1T15M-9	Plastic	WC1-358-0664	1T15M-9	61
NAD-29828	9540	1T15M-9	Plastic	WC1-358-0664	1T15V-8	71
NAD-29828	9540	1T15M-9	Plastic	WC1-358-0664	1T15LC-12	28

Firestone

1T Piston Index by Piston Drawing Number

PISTON DRAWING NO.	PISTON COMPONENT NO.	PISTON TYPE	MATERIAL	PISTON AON	BELLOWS	PAGE NO.
NAD-29828	9540	1T15M-9	Plastic	WC1-358-0664	1T15MB-TW-12	65
NAD-29828	9540	1T15M-9	Plastic	WC1-358-0664	1T15M-7.5	54, 55
NAD-29848	9540	1T15M-9	Plastic	WC1-358-0664	1T15M-11	64
NAD-30174	9604	1T15ZR-6	Aluminum	WC1-358-1624	1T15ZR-6	73
NAD-30515	9533	1T17BB-2	Plastic	WC1-358-1644	1T17CD-3	79
NAD-30515	9533	1T17BB-2	Plastic	WC1-358-1644	1T17BB-2	75
NAD-31181	9557	1T15MP-6	Plastic	WC1-358-1654	1T15VMW-8	72
NAD-31181	9557	1T15MP-6	Plastic	WC1-358-6262	1T15MPW-7	53
NAD-31215	9646	1T17B17	Steel	N/A	1T17BP-17	78
NAD-31288	9648	1T17B-4	Steel	WC1-358-1649	1T17CA-3	79
NAD-31612	9676	1T15ZR-6	Steel	N/A	1T15ZR-6	74
NAD-31622	9645	1T15CCR-6	Steel	N/A	1T15AA-6	17
NAD-31635	3882	1T17CA-5	Steel		1T17CA-6	80
NAD-31791	9596	1T15S-6	Plastic	N/A	1T15AA-3	16
NAD-31862	9644	1T19ZR-6.2	Steel	N/A	1T19ZK-5.7	93, 94
NAD-32590	9671	1T17AZF	Steel	N/A	1T17AEZR-5	75
NAD-32590	9671	1T17AZF	Steel	N/A		75
NAD-32767	9561	1T15M-6	Plastic	WC1-358-1606	1T15MT-6	52
NAD-32767	9561	1T15M-6	Plastic	WC1-358-1606	1T15M-8	58
NAD-32768	9560	1T15M-6	Plastic	WC1-358-1620	1T15M-6	48
NAD-32768	9560	1T15M-6	Plastic	WC1-358-1620	1T15M-6	49
NAD-32768	9560	1T15M-6	Plastic	WC1-358-1620	1T15M-8	56, 57
NAD-32770	9677	1T19E-2	Steel	N/A	1T19F-11 or 1T19L-11	90
NAD-33001	9642	1T19F-9	Aluminum	N/A	1T19F-11 or 1T19L-11	89
NAD-33610	9562	1T19L-9	Plastic	WC1-358-1651	1T19L-11	90
NAD-34178	9563	1T15M-6	Plastic	N/A	1T15M-7.5	56
NAD-34318	3894	1T19G-5	Aluminum	WC1-M58-1653	1T19LC-5	83
NBD-10180	9769	1T19J-2	Aluminum	WC1-358-0685	1T19J-1	93
NBD-10267	9656	1T15M-2	Aluminum	WC1-358-0652	1T15M-4	40
NBD-10267	9656	1T15M-2	Aluminum	WC1-358-0652	1T15LP-2	22
NBD-10267	9656	1T15M-2	Aluminum	WC1-358-0652	1T15M-2	36, 37
NBD-10267	9656	1T15M-2	Aluminum	WC1-358-0652	1T15M-4	42
NBD-10267	9656	1T15M-2	Aluminum	WC1-358-0652	1T15L-4	25
NBD-10267	9656	1T15M-2	Aluminum	WC1-358-0652	1T15M-4	43, 45

Cross References

1T Piston Index by Piston Drawing Number

PISTON DRAWING NO.	PISTON COMPONENT NO.	PISTON TYPE	MATERIAL	PISTON AON	BELLOWS	PAGE NO.
NBD-10378	3822	1T15M-2	Aluminum		1T15M-2	35
NBD-10437	9653	1T15M-9	Aluminum	WC1-358-9453	1T15M-11	63, 64
NBD-10438	9654	1T15M-0	Aluminum	WC1-358-0663	1T15L-2	19
NBD-10438	9654	1T15M-0	Aluminum	WC1-358-0663	1T15M-0	30-32
NBD-10438	9654	1T15M-0	Aluminum	WC1-358-0663	1T15L-2	22
NBD-10438	9654	1T15M-0	Aluminum	WC1-358-0663	1T15T-1	66
NBD-10439	9655	1T15M-0	Aluminum	WC1-358-9454	1T15M-0	29
NBD-10439	9655	1T15M-0	Aluminum	WC1-358-9454	1T15M-0	30
NBD-10439	9655	1T15M-0	Aluminum	WC1-358-9454	1T15M-0	31
NBD-10439	9655	1T15M-0	Aluminum	WC1-358-9454	1T15TM-1	67
NBD-10439	9655	1T15M-0	Aluminum	WC1-358-9454	1T15L-2	21
NBD-10441	9508	1T14C-1	Plastic	WC1-358-0754	1T14CB-1	8
NBD-10441	9508	1T14C-1	Plastic	WC1-358-0754	1T14C-3	11
NBD-10472	9659	1T15T-3	Aluminum	WC1-358-0683	1T15LP-1.5	19
NBD-10472	9659	1T15T-3	Aluminum	WC1-358-0683	1T15L-4	24, 25
NBD-10472	9659	1T15T-3	Aluminum	WC1-358-0683	1T15L-2	21, 22
NBD-10472	9659	1T15T-3	Aluminum	WC1-358-0683	1T15L-2	21
NBD-10500	9555	1T14C-1	Plastic	WC1-358-0609	1T14C-1	7
NBD-10500	9555	1T14C-1	Plastic	WC1-358-0609	1T14CB-1	8, 9
NBD-11498	9651	1T14C-3	Aluminum	WC1-358-9095	1T14C-1	7
NBD-11498	9651	1T14C-3	Aluminum	WC1-358-9095	1T14C-3	10
NBD-11498	9651	1T14C-3	Aluminum	WC1-358-9095	1T14C-5	12
NBD-11498	9651	1T14C-3	Aluminum	WC1-358-9095	1T14CB-1	8
NBD-11689	9754	1T14C-7	Aluminum	WC1-358-1603	1T14C-8	13
NBD-11689	9754	1T14C-7	Aluminum	WC1-358-1603	1T14C-6	12
NBD-11689	9754	1T14C-7	Aluminum	WC1-358-1603	1T14C-7	13
NBD-11689	9754	1T14C-7	Aluminum	WC1-358-1603	1T14C-6	12
NBD-12639	9663	1T15L-2	Aluminum	N/A	1T15LC-2.5	23, 24
NBD-12639	9663	1T15L-2	Aluminum	N/A	1T15LC-4.5	26
NBD-14153	3853	1T15M-9	Aluminum		1T15M-11	65
NBD-14213	9681	1T15Y-1	Aluminum	WC1-358-1612	1T15TQ-1	67-69
NBD-14366	9696	1T15M-7.5	Aluminum	WC1-358-1636	1T15M-7.5	56
NBD-14404	9528	1T15V-1	Plastic	WC1-358-0667	1T17C-3	78
NBD-14404	9528	1T15V-1	Plastic	WC1-358-0667	1T15M-2	36
NBD-14404	9528	1T15V-1	Plastic	WC1-358-0667	1T15V-1	69
NBD-14404	9528	1T15V-1	Plastic	WC1-358-0667	1T15V-3	70
NBD-14503	9691	1T15L-4	Aluminum	WC1-358-0606	1T15L-4	25, 26
NBD-14537	9505	1T15T-0	Plastic	WC1-358-1642	1T15TM-1	66

Firestone

1T Piston Index by Piston Drawing Number

PISTON DRAWING NO.	PISTON COMPONENT NO.	PISTON TYPE	MATERIAL	PISTON AON	BELLOWS	PAGE NO.
NBD-14537	9505	1T15T-0	Plastic	WC1-358-1642	1T15TQ-1	69
NBD-14537	9505	1T15T-0	Plastic	WC1-358-1642	1T15T-2	69
NBD-14537	9505	1T15T-0	Plastic	WC1-358-1642	1T15T-1	66
NBD-14537	9505	1T15T-0	Plastic	WC1-358-1642	1T15TM-1	67
NBD-8055	9742	1T15M-2	Aluminum	WC1-358-0658	1T15M-2	36
NBD-8183	9743	1T15M-2	Aluminum	WC1-358-0653	1T15L-2	20
NBD-8183	9743	1T15M-2	Aluminum	WC1-358-0653	1T15L-4	25
NBD-8312	9745	1T15T-0	Aluminum	WC1-358-0682	1T15T-1	65
NBD-8626	9708	1T14C-1	Aluminum	WC1-358-0600	1T14C-1	7
NBD-8626	9708	1T14C-1	Aluminum	WC1-358-0600	1T14C-1 or 1T14F-2	7, 8
NBD-8626	9708	1T14C-1	Aluminum	WC1-358-0600	1T14C-3 or 1T14F-4	9
NBD-8626	9708	1T14C-1	Aluminum	WC1-358-0600	1T14C-3	9-11
NBD-8626	9708	1T14C-1	Aluminum	WC1-358-0600	1T14C-7 or 1T14F-8	13
NBD-8724	9727	1T15M-4	Aluminum	WC1-358-0651	1T15M-4	44
NBD-8725	9727	1T15M-4	Aluminum	WC1-358-0651	1T15M-4	40-42
NBD-8725	9727	1T15M-4	Aluminum	WC1-358-0651	1T15M-2	35
NBD-8725	9727	1T15M-4	Aluminum	WC1-358-0651	1T15M-6	46, 50
NBD-8725	9727	1T15M-4	Aluminum	WC1-358-0651	1T15V-8	72
NBD-8881	8789	1T15S-6	Plastic	N/A	1T15S-6 or 1T15AA-3	14
NBD-8987	9728	1T15V-7	Aluminum	WC1-358-0669	1T15M-6	49
NBD-8987	9728	1T15V-7	Aluminum	WC1-358-0669	1T15V-8	70
NBD-8987	9728	1T15V-7	Aluminum	WC1-358-0669	1T15M-4	43
NBD-9242	9757	1T15B-2	Aluminum	N/A	1T15S-6 or 1T15AA-3	14
NBD-9242	9757	1T15B-2	Aluminum	N/A	1T15AA-3	15
NBD-9611	9806	1T15L-6HG	Aluminum	WC1-358-0660	1T15M-6	51
NBD-9611	9809	1T15L-6HG	Aluminum	WC1-358-0660	1T15M-6	48, 51
NBD-9673	9744	1T15MJ-6	Aluminum	N/A	1T15MJ-6	51, 52

Cross References

All Parts Assembly Order Number Index

AON'S	PAGE NO.
W01-358-2119	7
W01-358-2120	7
W01-358-2131	7
W01-358-3400	102
W01-358-3402	102
W01-358-3406	102
W01-358-3420	102
W01-358-5297	8
W01-358-5310	7
W01-358-5311	7
W01-358-5319	8
W01-358-5323	8
W01-358-5328	8
W01-358-5335	11
W01-358-5336	12
W01-358-5405	9
W01-358-5406	9
W01-358-5408	9
W01-358-5410	10
W01-358-5412	10
W01-358-5414	10
W01-358-5422	10
W01-358-5423	10
W01-358-5426	13
W01-358-5429	13
W01-358-5433	11
W01-358-5434	11
W01-358-5436	11
W01-358-5439	12
W01-358-5503	90
W01-358-5505	90
W01-358-5509	91
W01-358-5511	91
W01-358-5702	13
W01-358-5712	13
W01-358-5765	66
W01-358-5766	66
W01-358-5770	67
W01-358-5771	67

AON'S	PAGE NO.
W01-358-5772	67
W01-358-5773	68
W01-358-5775	68
W01-358-5776	68
W01-358-5777	68
W01-358-5789	68
W01-358-5792	69
W01-358-5900	108
W01-358-6258	72
W01-358-6262	53
W01-358-6392	108
W01-358-6789	114
W01-358-6799	120
W01-358-6800	119
W01-358-6801	119
W01-358-6803	119
W01-358-6805	119
W01-358-6808	120
W01-358-6817	109
W01-358-6831	101
W01-358-6856	104
W01-358-6883	108
W01-358-6884	105
W01-358-6886	108
W01-358-6890	103
W01-358-6897	105
W01-358-6900	104
W01-358-6902	105
W01-358-6905	105
W01-358-6908	106
W01-358-6910	104
W01-358-6926	104
W01-358-6927	109
W01-358-6932	106
W01-358-6935	106
W01-358-6940	106
W01-358-6941	106
W01-358-6943	109
W01-358-6944	109

AON'S	PAGE NO.
W01-358-6945	109
W01-358-6946	110
W01-358-6947	110
W01-358-6948	110
W01-358-6949	107
W01-358-6960	110
W01-358-6962	110
W01-358-6994	98
W01-358-7008	98
W01-358-7009	98
W01-358-7025	101
W01-358-7025	136
W01-358-7043	98
W01-358-7057	101
W01-358-7088	99
W01-358-7093	99
W01-358-7094	100
W01-358-7096	100
W01-358-7103	99
W01-358-7104	99
W01-358-7105	99
W01-358-7112	100
W01-358-7113	98
W01-358-7117	100
W01-358-7118	118
W01-358-7123	117
W01-358-7135	117
W01-358-7136	117
W01-358-7140	118
W01-358-7145	118
W01-358-7146	118
W01-358-7180	111
W01-358-7181	111
W01-358-7183	111
W01-358-7185	111
W01-358-7226	122
W01-358-7230	122
W01-358-7244	121
W01-358-7271	121

Firestone

All Parts Assembly Order Number Index

AON'S	PAGE NO.
W01-358-7274	132
W01-358-7275	122
W01-358-7276	133
W01-358-7279	102
W01-358-7286	132
W01-358-7294	122
W01-358-7304	133
W01-358-7325	103
W01-358-7330	103
W01-358-7344	111
W01-358-7400	112
W01-358-7401	112
W01-358-7403	112
W01-358-7404	112
W01-358-7405	112
W01-358-7406	113
W01-358-7408	113
W01-358-7409	113
W01-358-7410	113
W01-358-7423	113
W01-358-7424	114
W01-358-7429	114
W01-358-7437	114
W01-358-7443	114
W01-358-7444	115
W01-358-7446	115
W01-358-7447	115
W01-358-7462	101
W01-358-7472	116
W01-358-7473	115
W01-358-7483	115
W01-358-7499	116
W01-358-7505	103
W01-358-7512	121
W01-358-7545	116
W01-358-7550	116
W01-358-7555	117
W01-358-7557	120
W01-358-7667	33

AON'S	PAGE NO.
W01-358-7686	107
W01-358-7705	103
W01-358-7726	100
W01-358-7761	132
W01-358-7781	120
W01-358-7782	120
W01-358-7788	107
W01-358-7790	116
W01-358-7792	121
W01-358-7794	121
W01-358-7795	107
W01-358-7796	127
W01-358-7797	127
W01-358-7798	127
W01-358-7800	128
W01-358-7808	128
W01-358-7816	128
W01-358-7818	128
W01-358-7838	129
W01-358-7839	129
W01-358-7843	129
W01-358-7844	129
W01-358-7845	130
W01-358-7846	130
W01-358-7847	130
W01-358-7848	130
W01-358-7850	131
W01-358-7852	128
W01-358-7853	131
W01-358-7855	131
W01-358-7859	131
W01-358-7862	131
W01-358-7872	132
W01-358-7892	107
W01-358-7897	108
W01-358-7915	132
W01-358-7927	119
W01-358-7954	126
W01-358-7956	126

AON'S	PAGE NO.
W01-358-7990	123
W01-358-7994	123
W01-358-7995	123
W01-358-7996	123
W01-358-7998	123
W01-358-8006	124
W01-358-8008	124
W01-358-8010	124
W01-358-8014	124
W01-358-8016	124
W01-358-8018	125
W01-358-8025	125
W01-358-8027	125
W01-358-8030	125
W01-358-8032	125
W01-358-8033	126
W01-358-8038	126
W01-358-8039	126
W01-358-8042	127
W01-358-8043	127
W01-358-8050	93
W01-358-8051	93
W01-358-8052	94
W01-358-8053	94
W01-358-8055	93
W01-358-8058	93
W01-358-8088	81
W01-358-8091	83
W01-358-8092	83
W01-358-8093	87
W01-358-8171	118
W01-358-8184	17
W01-358-8197	33
W01-358-8198	34
W01-358-8201	34
W01-358-8203	34
W01-358-8204	34
W01-358-8207	34
W01-358-8235	117

Cross References

All Parts Assembly Order Number Index

AON'S	PAGE NO.
W01-358-8500	82
W01-358-8597	19
W01-358-8600	69
W01-358-8614	79
W01-358-8617	79
W01-358-8623	80
W01-358-8632	75
W01-358-8636	78
W01-358-8676	75
W01-358-8708	80
W01-358-8709	79
W01-358-8710	79
W01-358-8713	80
W01-358-8723	75
W01-358-8724	78
W01-358-8729	75
W01-358-8733	78
W01-358-8735	79
W01-358-8737	78
W01-358-8738	78
W01-358-8740	75
W01-358-8744	77
W01-358-8746	77
W01-358-8748	77
W01-358-8749	77
W01-358-8751	76
W01-358-8752	76
W01-358-8753	76
W01-358-8755	76
W01-358-8756	76
W01-358-8760	81
W01-358-8761	81
W01-358-8764	90
W01-358-8774	84
W01-358-8776	84
W01-358-8778	84
W01-358-8779	87
W01-358-8780	87
W01-358-8781	87

AON'S	PAGE NO.
W01-358-8782	77
W01-358-8787	81
W01-358-8792	88
W01-358-8793	91
W01-358-8796	88
W01-358-8802	39
W01-358-8803	39
W01-358-8805	40
W01-358-8806	40
W01-358-8810	40
W01-358-8813	40
W01-358-8816	40
W01-358-8817	41
W01-358-8824	45
W01-358-8829	45
W01-358-8842	59
W01-358-8852	59
W01-358-8855	59
W01-358-8856	60
W01-358-8864	60
W01-358-8868	12
W01-358-8872	8
W01-358-8878	35
W01-358-8882	32
W01-358-8886	18
W01-358-8888	53
W01-358-8900	19
W01-358-8901	19
W01-358-8903	53
W01-358-8911	65
W01-358-8918	24
W01-358-8919	24
W01-358-8922	24
W01-358-8924	45
W01-358-8927	46
W01-358-8930	35
W01-358-8931	35
W01-358-8932	35
W01-358-8934	36

AON'S	PAGE NO.
W01-358-8935	36
W01-358-8942	25
W01-358-8944	52
W01-358-8949	26
W01-358-8951	25
W01-358-8958	22
W01-358-8959	23
W01-358-8961	28
W01-358-8963	29
W01-358-8964	29
W01-358-8965	16
W01-358-8971	29
W01-358-8972	29
W01-358-8976	29
W01-358-8977	12
W01-358-8979	12
W01-358-8984	94
W01-358-8986	30
W01-358-8991	36
W01-358-8992	9
W01-358-8997	9
W01-358-9004	46
W01-358-9008	41
W01-358-9010	41
W01-358-9011	41
W01-358-9015	27
W01-358-9026	46
W01-358-9029	30
W01-358-9031	30
W01-358-9033	30
W01-358-9036	30
W01-358-9039	31
W01-358-9043	13
W01-358-9049	14
W01-358-9053	36
W01-358-9059	41
W01-358-9063	42
W01-358-9068	42
W01-358-9069	42

Firestone

All Parts Assembly Order Number Index

AON'S	PAGE NO.
W01-358-9070	42
W01-358-9071	42
W01-358-9073	14
W01-358-9075	20
W01-358-9076	14
W01-358-9077	31
W01-358-9078	36
W01-358-9082	46
W01-358-9083	46
W01-358-9092	47
W01-358-9093	47
W01-358-9096	47
W01-358-9097	51
W01-358-9098	52
W01-358-9101	60
W01-358-9105	37
W01-358-9113	37
W01-358-9116	84
W01-358-9118	37
W01-358-9121	84
W01-358-9122	88
W01-358-9134	88
W01-358-9135	85
W01-358-9138	88
W01-358-9144	85
W01-358-9148	85
W01-358-9149	85
W01-358-9152	89
W01-358-9156	89
W01-358-9158	89
W01-358-9164	85
W01-358-9177	86
W01-358-9179	86
W01-358-9192	60
W01-358-9193	47
W01-358-9194	47
W01-358-9199	89
W01-358-9200	82
W01-358-9201	89

AON'S	PAGE NO.
W01-358-9203	60
W01-358-9204	82
W01-358-9210	48
W01-358-9211	48
W01-358-9213	48
W01-358-9214	90
W01-358-9215	82
W01-358-9216	82
W01-358-9218	83
W01-358-9219	48
W01-358-9221	86
W01-358-9223	48
W01-358-9227	49
W01-358-9228	49
W01-358-9238	61
W01-358-9240	61
W01-358-9243	61
W01-358-9245	61
W01-358-9249	69
W01-358-9250	73
W01-358-9251	69
W01-358-9252	73
W01-358-9256	49
W01-358-9259	14
W01-358-9260	65
W01-358-9264	91
W01-358-9265	63
W01-358-9268	38
W01-358-9269	73
W01-358-9270	70
W01-358-9274	70
W01-358-9275	71
W01-358-9277	83
W01-358-9284	24
W01-358-9285	14
W01-358-9287	56
W01-358-9290	15
W01-358-9291	26
W01-358-9293	27

AON'S	PAGE NO.
W01-358-9294	27
W01-358-9295	27
W01-358-9296	49
W01-358-9297	57
W01-358-9299	52
W01-358-9302	37
W01-358-9304	49
W01-358-9307	33
W01-358-9308	31
W01-358-9320	63
W01-358-9321	63
W01-358-9325	37
W01-358-9332	31
W01-358-9333	31
W01-358-9334	32
W01-358-9335	43
W01-358-9336	43
W01-358-9338	64
W01-358-9339	38
W01-358-9342	54
W01-358-9346	61
W01-358-9348	62
W01-358-9349	62
W01-358-9350	62
W01-358-9362	50
W01-358-9365	38
W01-358-9366	38
W01-358-9367	64
W01-358-9368	64
W01-358-9370	64
W01-358-9371	57
W01-358-9372	57
W01-358-9373	57
W01-358-9375	57
W01-358-9376	20
W01-358-9377	20
W01-358-9378	20
W01-358-9379	24
W01-358-9387	20

Cross References

All Parts Assembly Order Number Index

AON'S	PAGE NO.
W01-358-9388	50
W01-358-9392	50
W01-358-9394	62
W01-358-9402	65
W01-358-9410	66
W01-358-9415	25
W01-358-9421	67
W01-358-9422	18
W01-358-9423	67
W01-358-9438	25
W01-358-9439	25
W01-358-9440	21
W01-358-9445	21
W01-358-9447	21
W01-358-9448	21
W01-358-9457	21
W01-358-9459	22
W01-358-9463	43
W01-358-9466	52
W01-358-9467	43
W01-358-9470	71
W01-358-9471	71
W01-358-9472	71
W01-358-9473	71
W01-358-9474	50
W01-358-9476	22
W01-358-9477	22
W01-358-9478	11
W01-358-9482	43
W01-358-9483	44
W01-358-9484	44
W01-358-9491	72
W01-358-9496	50
W01-358-9501	72
W01-358-9502	72
W01-358-9504	72
W01-358-9505	32
W01-358-9507	44
W01-358-9538	64

AON'S	PAGE NO.
W01-358-9541	17
W01-358-9547	17
W01-358-9553	15
W01-358-9554	23
W01-358-9556	38
W01-358-9559	28
W01-358-9560	28
W01-358-9562	22
W01-358-9565	23
W01-358-9566	23
W01-358-9567	26
W01-358-9568	26
W01-358-9578	70
W01-358-9579	70
W01-358-9580	80
W01-358-9581	81
W01-358-9582	70
W01-358-9584	19
W01-358-9585	44
W01-358-9586	69
W01-358-9587	15
W01-358-9589	15
W01-358-9592	15
W01-358-9597	16
W01-358-9599	16
W01-358-9616	19
W01-358-9617	17
W01-358-9618	18
W01-358-9619	28
W01-358-9621	28
W01-358-9622	17
W01-358-9625	18
W01-358-9626	27
W01-358-9634	39
W01-358-9640	39
W01-358-9643	52
W01-358-9644	51
W01-358-9645	65
W01-358-9646	63

AON'S	PAGE NO.
W01-358-9647	58
W01-358-9648	58
W01-358-9649	58
W01-358-9650	66
W01-358-9651	66
W01-358-9652	16
W01-358-9654	58
W01-358-9663	59
W01-358-9668	65
W01-358-9675	18
W01-358-9681	23
W01-358-9690	51
W01-358-9697	44
W01-358-9774	39
W01-358-9780	73
W01-358-9781	73
W01-358-9782	74
W01-358-9797	45
W01-358-9798	45
W01-358-9807	32
W01-358-9811	86
W01-358-9825	87
W01-358-9825	92
W01-358-9855	26
W01-358-9875	62
W01-358-9876	63
W01-358-9891	91
W01-358-9896	92
W01-358-9902	54
W01-358-9915	92
W01-358-9921	54
W01-358-9922	54
W01-358-9923	54
W01-358-9928	92
W01-358-9929	92
W01-358-9935	55
W01-358-9936	55
W01-358-9942	55
W01-358-9943	55

Firestone

All Parts Assembly Order Number Index

AON'S	PAGE NO.
W01-358-9944	51
W01-358-9947	55
W01-358-9948	56
W01-358-9953	16
W01-358-9961	86
W01-358-9966	51
W01-358-9971	56
W01-358-9972	56
W01-358-9974	56
W01-358-9984	93
W01-358-9985	90
W01-M58-6260	53
W01-M58-6317	53
W01-M58-8650	35
W01-M58-8712	80
W01-M58-8798	83
W01-M58-9642	58
W01-M58-9656	59
W02-358-4003	148
W02-358-6754	137
W02-358-7001	137
W02-358-7007	142
W02-358-7012	145
W02-358-7017	148
W02-358-7024	150
W02-358-7029	147
W02-358-7031	141
W02-358-7032	146
W02-358-7035	143
W02-358-7036	150
W02-358-7037	145
W02-358-7038	149
W02-358-7040	140
W02-358-7041	138
W02-358-7042	146
W02-358-7043	150
W02-358-7044	150
W02-358-7045	146
W02-358-7046	133

AON'S	PAGE NO.
W02-358-7046	136
W02-358-7049	140
W02-358-7054	139
W02-358-7055	140
W02-358-7056	146
W02-358-7058	139
W02-358-7059	138
W02-358-7061	145
W02-358-7064	148
W02-358-7067	147
W02-358-7070	143
W02-358-7073	141
W02-358-7074	145
W02-358-7075	144
W02-358-7076	139
W02-358-7079	136
W02-358-7080	143
W02-358-7081	151
W02-358-7082	149
W02-358-7083	152
W02-358-7085	142
W02-358-7086	133
W02-358-7086	136
W02-358-7087	144
W02-358-7092	151
W02-358-7093	151
W02-358-7098	139
W02-358-7100	138
W02-358-7103	144
W02-358-7106	142
W02-358-7108	148
W02-358-7109	149
W02-358-7110	152
W02-358-7116	143
W02-358-7149	140
W02-358-7150	137
W02-358-7151	147
W02-358-7152	151
W02-358-7155	138

AON'S	PAGE NO.
W02-358-7200	152
W02-358-7201	137
W02-358-7204	142
W02-358-7205	149
W02-358-7206	144
W02-358-7208	147
W02-358-7209	141
W02-358-7215	152
W02-358-9901	141
W02-358-9902	153
W21-760-9000	153
W21-760-9001	153
W21-760-9002	153
W21-760-9011	154
W26-358-9911	154
W26-358-9912	154
W26-358-9913	154
WC1-358-1690	32
WC1-358-1691	33
WC1-358-1692	33
WC1-358-3874	74
WC1-358-3876	74
WC1-358-3900	74
WC1-358-3901	74

Cross References

New and Obsolete Parts (added or removed from catalog)

New Parts (added)	
Bellows No.	Assembly No.
1T15AA-3	W01-358-9043
1T15LP-6	W01-358-9015
1T15M-1	W01-358-8882
1T15MJ-6	W01-358-9097
1T15MJ-6	W01-358-9098
1T17ALZR-5	W01-358-8632
1T17CA-6	W01-358-8623
1T19L-11	W01-358-9152

Obsolete Parts (removed)	
Bellows No.	Assembly No.
1T19ZK-5.7	W01-358-8058
1T15M-9	W01-358-9875
1T15M-9	W01-358-9876
1T15M-2	W01-358-9807
SPACER FOR 9807	WC1-358-1690
SPACER FOR 9807	WC1-358-1691
SPACER FOR 9807	WC1-358-1692
SLEEVE	W02-358-7215
113-1X88-1	W01-358-7113
1T15M-11	W01-358-9321

Firestone

Notes

Firestone

**World's Number 1
Air Spring.**



FIRESTONE INDUSTRIAL PRODUCTS COMPANY

Air Spring Warranty Evaluation Criteria



Firestone air springs are designed to provide years and thousands of miles of trouble free service. The durability of Firestone air springs is such that they will often outlast other maintenance items on your suspension, such as bushings, shocks, leveling valves or regulators. Airidesprings by Firestone are warranted to be free of material defects and/or workmanship for various periods of time, depending upon the application.

Firestone Industrial Products Company offers a complete line of Airide springs, with replacement springs available for virtually every vehicular air suspension system.

Since each individual air spring is closely examined and pressure tested at the factory, the vast majority of premature failures and consequent warranty returns are found not to be defective, but fail because of abuse caused by other problems associated with the suspension.

Before you install a new air spring, you should carefully examine the old one to determine what caused it to fail. If it was due to a defect in the suspension system, then the new air spring may also fail unless you correct the problem.

The information on the next two pages was developed to illustrate the types of failures that may occur, and to assist you in determining the cause and corrective action required.

AIRIDE™

SPRINGS

When applied and maintained properly, Airide® springs can provide thousands of miles of trouble-free service. Most failures are caused by a lack of suspension maintenance or improper application. This is a guide to common air spring failures that are *not* covered by warranty.

MISALIGNMENT

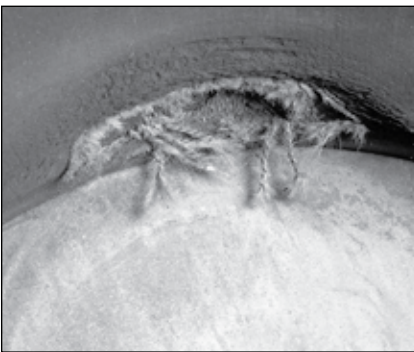
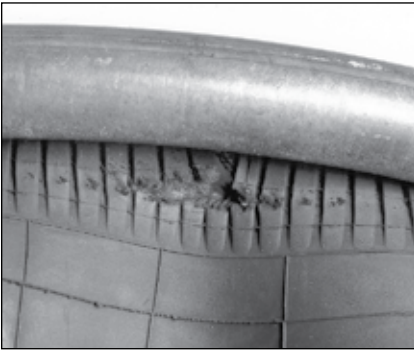

- Appearance or Condition**
- Off-center bumper contact
 - Same as abrasion or bottoming out
- Possible Causes**
- Worn bushing
 - Improper suspension installation

LOOSE GIRDLE HOOP

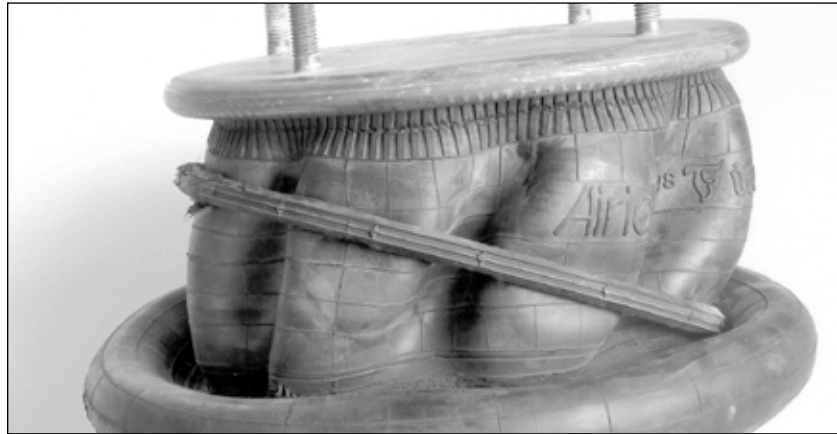

Appearance or Condition

- Rubber bellows distorted and girdle hoop torn loose

Possible Causes

- Running at extended positions with low air pressure

BOTTOMING OUT

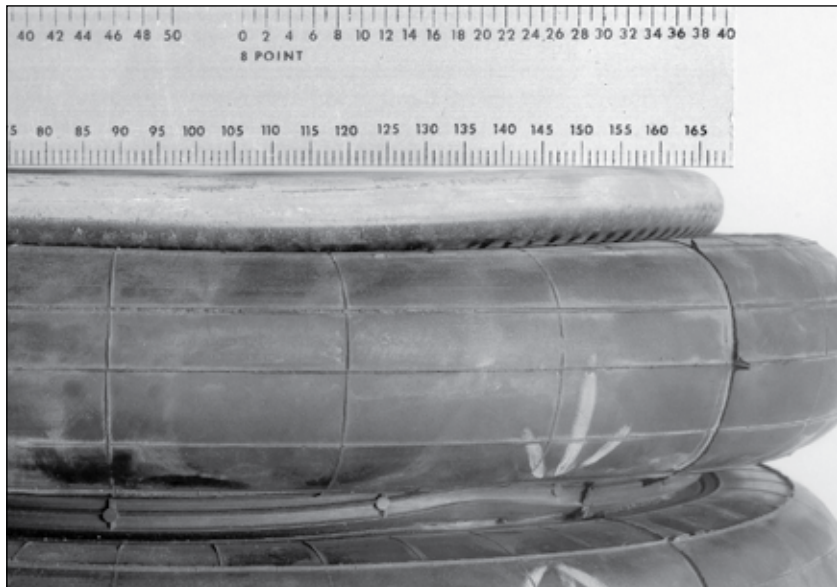

Appearance or Condition

- Bead plate concave
- Internal bumper loose
- Hole in girdle hoop area (convoluted)
- Hole in bead plate junction area
- Leaking around blind nuts

Possible Causes

- Broken or defective shock absorber
- Defective leveling valve
- Overloaded vehicle
- Pressure regulator set too low
- Wrong air spring (too tall)

Warranty Evaluation Criteria

ABRASION



Appearance or Condition

- Hole rubbed into side of bellows
- Hole in bellows area that rolls over piston (reversible sleeve style)

Possible Causes

- Structural interference, such as:
 - broken shock
 - loose air line
 - misalignment
 - worn bushings
- No air pressure (reversible sleeve style)
- Foreign material (sand, rocks, etc.)
- Wrong air spring

CIRCUMFERENTIAL CUTS



Appearance or Condition

- Bellows cut in circle at bead plate junction
- Bellows cut in circle at piston junction (reversible sleeve style)

Possible Causes

- High pressure, fully extended for long periods of time
- Impact in compressed position

OVER EXTENSION

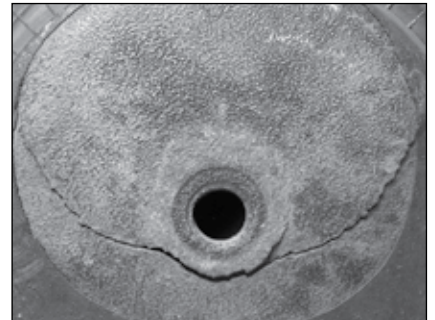
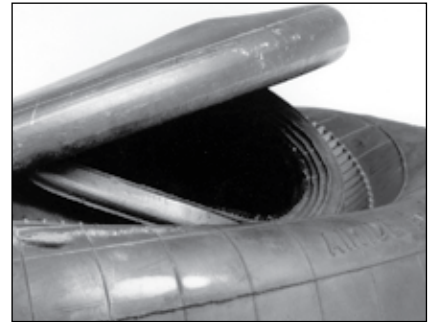
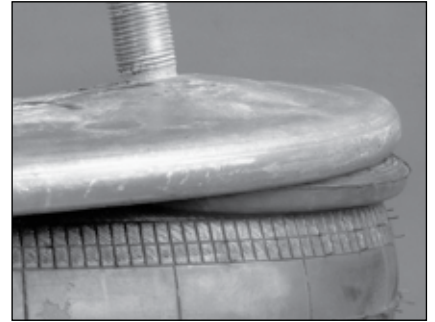

Appearance or Condition

- Bead plate convex, especially around blind nuts or studs
- Rubber bellows separated from bead plate
- Leaking at blind nuts or studs
- Leaking at end closure (reversible sleeve)
- Loose girdle hoop on convoluted style

Possible Causes

- Broken or wrong shock absorber
- Defective leveling valve
- Ride position too high
- Defective upper stop (lift)
- Wrong air spring (too short)

PREVENTIVE MAINTENANCE CHECKLIST

Listed below are items that can be checked when the vehicle is in for periodic maintenance.

Never attempt to service the air suspension on a truck or trailer with the air springs inflated.

1 Inspect the O.D. of the airspring. Check for signs of irregular wear or heat cracking.

2 Inspect air lines to make sure contact doesn't exist between the air line and the O.D. of the air spring. Air lines can rub a hole in an air spring very quickly.

3 Check to see that there is sufficient clearance around the complete circumference of the air spring while at its maximum diameter.

4 Inspect the O.D. of the piston for buildup of foreign materials. (On a reversible sleeve style air spring, the piston is the bottom component of the air spring).

5 Correct ride height should be maintained. All vehicles with air springs have a specified ride height established by the O.E.M. manufacturer. This height, which is found in your service manual, should be maintained within 1/4". This dimension can be checked with the vehicle loaded or empty.

6 Leveling valves (or height control valves) play a large part in ensuring that the total air spring system works as required. Clean, inspect and replace, if necessary.

7 Make sure you have the proper shock absorbers and check for leaking hydraulic oil and worn or broken end connectors. If a broken shock is found, replace it immediately. The shock absorber will normally limit the rebound of an air spring and keep it from overextending.

8 Check the tightness of all mounting hardware (nuts and bolts). If loose, re-torque to the manufacturer's specifications. Do not over-tighten.

CLEANING

9 APPROVED
Approved cleaning media are soap and water, methyl alcohol, ethyl alcohol and isopropyl alcohol.

NON-APPROVED
Non-approved cleaning media include all organic solvents, open flames, abrasives and direct pressurized steam cleaning.

The total inspection process described on this page can be done in just a matter of minutes. If you find one of the above conditions exists, please take corrective action to ensure that it is fixed properly. It will save you both time and money.

Firestone

**World's Number 1
Air Spring.**

FIRESTONE INDUSTRIAL PRODUCTS COMPANY

**1-800-888-0650
www.firestoneip.com**

Alignment Definitions

Alignment is based on the orientation of the lower bead plate or piston compared to the upper bead plate. Alignments other than those shown are noted in the bottom view.

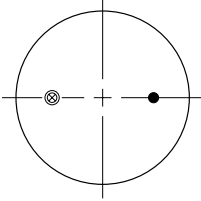
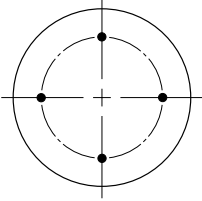
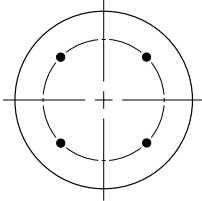
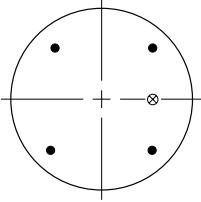
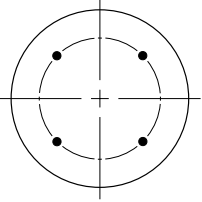
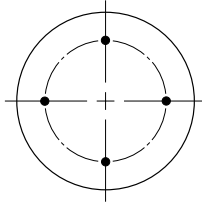
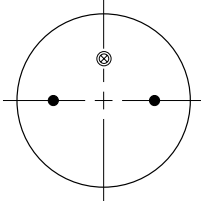
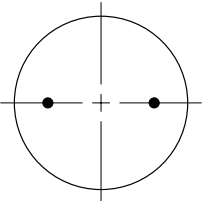
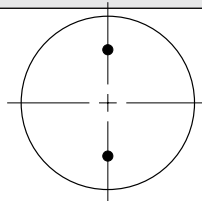
BEAD PLATE TOP VIEW	BEAD PLATE OR PISTON BOTTOM VIEW	
	PARALLEL ALIGNMENT	45 DEGREE ALIGNMENT
I. 		
II. 		
III. 		90° ALIGN. 

Firestone

Notes



Stocked and Distributed by

Firestone

**World's Number 1
Air Spring.**



FIRESTONE INDUSTRIAL PRODUCTS COMPANY

800.888.0650

www.firestoneip.com